



DeviceEdge_AGX Orin Series

AIE-PX11/AIE-PX12

AIE-PX21/AIE-PX22

USER MANUAL

Document Change History

Version	Date	Description
V1.0	2023/08/01	Initial Release.

Disclaimer

The information presented in this document is for informational purposes only and may contain technical inaccuracies, omissions and typographical errors.

The information contained herein is subject to change and may be rendered inaccurate for many reasons, including but not limited to product and roadmap changes, component and motherboard version changes, new model and/or product releases, product differences between differing manufacturers, software changes, BIOS flashes, firmware upgrades, or the like. Aetina assumes no obligation to update or otherwise correct or revise this information. However, Aetina reserves the right to revise this information and to make changes from time to time to the content hereof without obligation of Aetina to notify any person of such revisions or changes.

Aetina makes no representations or warranties with respect to the contents hereof and assumes no responsibility for any inaccuracies, errors or omissions that may appear in this information. Aetina specifically disclaims any implied warranties of merchantability or fitness for any particular purpose. in no event will Aetina be liable to any person for any direct, indirect, special or other consequential damages arising from the use of any information contained herein, even if nvidia is expressly advised of the possibility of such damages.

Copyright Notice

No part of this manual may be reproduced, copied, translated, or transmitted in any form or by any means without the prior written permission of the original manufacturer. Information provided in this manual is intended to be accurate and reliable. However, the original manufacturer assumes no responsibility for its use, or for any infringements upon the rights of third parties that may result from its use.

The material in this document is for product information only and is subject to change without notice. While reasonable efforts have been made in the preparation of this document to assure its accuracy, Aetina assumes no liabilities resulting from errors or omissions in this document, or from the use of the information contained herein.

Aetina reserves the right to make changes in the product design without notice to its users.

Version 1.0

Copyright©2022 by Aetina, Inc. All rights reserved.

Acknowledgements

All other products' name or trademarks are properties of their respective owners.

- NVIDIA®, the NVIDIA logo, Jetson™ and Jetson Xavier™ are trademarks of the NVIDIA Corporation
- Intel®, Core™ are trademarks of Intel®, Corporation.
- Microsoft Windows® is a registered trademark of Microsoft Corp
- IBM and VGA are trademarks of International Business Machines Corporation.
- Ubuntu is a registered trademark of Canonical
- ESS is a trademark of ESS Technology, Inc.

All other product names or trademarks are properties of their respective owners. No ownership is implied or assumed for products, names or trademarks not herein listed by the publisher of this document. For more information about this and other Aetina products, please visit our web-site at: <http://www.Aetina.com/>

Customer Support Overview

Contact your distributor, sales representative, or Aetina's customer service center for technical support if you need additional assistance. Please have the following information ready before you call:

- Product name and serial number
- Description of your peripheral attachments
- Description of your software (operating system, version, application software, etc.)
- A complete description of the problem
- The exact wording of any error messages

Visit the Aetina website at <https://www.Aetina.com/support-warranty-policy.php> where you can find the latest information about the product.

Contact Information

Aetina Corporation | Headquarters

2F-1, No.237, Sec.1, Datong Rd., Xizhi Dist., New Taipei City 221, TAIWAN

Phone +886-2-7709 2568

Fax +886-2-7746 1102

Mail sales@Aetina.com

Worldwide Technical Support

Mail Tech_support@aetina.com

Product Warranty (2 years)

Aetina warrants to you, the original purchaser, that each of its products will be free from defects in materials and workmanship for two years from the date of purchase.

This warranty does not apply to any products which have been repaired or altered by persons other than repair personnel authorized by Aetina, or which have been subject to misuse, abuse, accident or improper installation. Aetina assumes no liability under the terms of this warranty as a consequence of such events.

Because of Aetina's high quality-control standards and rigorous testing, most of our customers never need to use our repair service. If an Aetina product is defective, it will be repaired or replaced at no charge during the warranty period. For out of warranty repairs, you will be billed according to the cost of replacement materials, service time and freight. Please consult your dealer for more details.

If you think you have a defective product, follow these steps:

1. Collect all the information about the problem encountered. (For example, CPU speed, Aetina products used other hardware and software used, etc.) Note anything abnormal and list any onscreen messages you get when the problem occurs.
2. Call your dealer and describe the problem. Please have your manual, product, and any helpful information readily available.
3. If your product is diagnosed as defective, obtain an RMA (return merchandise authorization) number from your dealer. This allows us to process your return more quickly.
4. Carefully pack the defective product, a fully-completed Repair and Replacement Order Card and a photocopy of the proof of purchase date (such as your sales receipt) in a shippable container. A product returned without proof of the purchase date is not eligible for warranty service.
5. Write the RMA number visibly on the outside of the package and ship it prepaid to your dealer.

ESD Warning

This product, like all electronic products, uses the product that can be damaged by electrostatic discharge (ESD). When handling, care must be taken so that the devices are not damaged. Damage due to inappropriate handling is not covered by the warranty. The following precautions must be taken:

- Do not open the protective conductive packaging until you have read the following and are at an approved anti-static workstation.
- If working on a prototyping board, use a soldering iron or station that is marked as ESD-safe.
- Always disconnect the product from the prototyping board when it is being worked on.
- Always discharge yourself by touching a grounded bare metal surface or approved anti-static mat before picking up an ESD - sensitive electronic component.
- Use an approved anti-static mat to cover your work surface.

Safety Precautions

Please read the following safety instructions carefully. It is advised that you keep this manual for future references:

1. All cautions and warnings on the equipment should be noted.
2. Make sure the power source matches the power rating of the device.
3. Position the power cord so that people cannot step on it. Do not place anything over the power cord.
4. For plug-in equipment, the power outlet socket must be located near the equipment and must be easily accessible.
5. Disconnect this equipment from any AC outlet before cleaning. Use a damp cloth. Do not use liquid or spray detergents for cleaning.
6. Always completely disconnect the power before working on the system's hardware.
7. Keep this equipment away from humidity.
8. Put this equipment on a reliable surface during installation. Dropping it or letting it fall may cause damage.
9. The openings on the enclosure are for air convection. Protect the equipment from overheating. **DO NOT COVER THE OPENINGS.**
10. Be sure that the room in which you choose to operate your system has adequate air circulation. Ensure that the chassis cover is secure.
11. The chassis design allows cooling air to circulate effectively. An open chassis permits air leaks, which may interrupt and redirect the flow of cooling air from internal components.
12. Never pour any liquid into an opening. This may cause fire or electrical shock.
13. If the equipment is not used for a long time, disconnect it from the power source to avoid damage by transient overvoltage.
14. Never open the equipment. For safety reasons, the equipment should be opened only by qualified service personnel.
15. If any of the following situations arises, please contact our service personnel:
 - Damaged power cord or plug
 - Liquid intrusion to the device
 - Exposure to moisture
 - Device is not working as expected or in a manner as described in this manual
 - The device is dropped or damaged
 - vi. Any obvious signs of damage displayed on the device

Contents

- 1. Introduction 7**
 - 1.1 Features7
 - 1.2 Specifications8
- 2. Hardware Information..... 10**
 - 2.1 I/O Interface10
 - 2.2 External Connector Summary10
 - 2.2.1 Connector Interface.....11
 - 2.3 Power Consumption16
 - 2.4 Mechanical Dimensions.....17
- 3. Software Installation 18**
- 4. Recovery Mode 18**
- 5. Initial Setup..... 19**
 - 5.1 Prepare the Materials19
 - 5.2 Hardware Connection19
 - 5.3 Setup Details19
- 6. EdgeEye 20**
 - 6.1 Aetina Edge Administration Platform20
 - 6.2 Feature.....21
 - 6.3 System Requirements21

1. Introduction

DeviceEdge AGX Orin series – AIE-PX11/ AIE-PX12/ AIE-PX21/ AIE-PX22 is a standard system, supporting for NVIDIA Jetson AGX Orin.



1.1 Features

- Supports NVIDIA Jetson AGX Orin™ 32GB/64GB module
- 2/4 x IEEE 802.3af GbE PSE ports
- 1 x GbE/1 x 10GbE LAN port
- 1 x B-Key/1 x E-Key/1 x M-Key slot
- Wide Input Voltage Range 9 to 36 VDC
- Operating Temperature -25°C ~ +55°C
- Supports OOB (out-of-band) powered by Innodisk (optional)
- Fanless Design

1.2 Specifications

■ System configuration

Specification	AIE-PX11 / AIE-PX12	AIE-PX21 / AIE-PX22
Module Compatibility	NVIDIA Jetson AGX Orin 32GB	NVIDIA Jetson AGX Orin 64GB
AI Performance	200 TOPs	275 TOPs
GPU	1792-core NVIDIA Ampere GPU with 56 Tensor Cores	2048-core NVIDIA Ampere GPU with 64 Tensor Cores
CPU	8-core Arm® Cortex®-A78AE v8.2 64-bit CPU 2MB L2 + 4MB L3	12-core Arm® Cortex®-A78AE v8.2 64-bit CPU 3MB L2 + 6MB L3
Memory	32 GB 256-bit LPDDR5 204.8 GB/s	64GB 256-bit LPDDR5 204.8 GB/s
Storage	64GB eMMC 5.1	
Display	1 x HDMI 2.0 Type A	
Audio	Line-out/Line-in/Mic (optional with daughter board)	
LAN	1 x RJ-45 GbE port, 1 x RJ-45 10GbE port	
USB	2 x USB 3.2 Gen1 Type A, 1 x USB 2.0 (DB-15), 1 x USB 2.0 Type-C (OTG only), 1 x USB 3.2 Gen 2 Type-C	
PoE Interface	2/4 x RJ-45 GbE PSE (IEEE 802.3af compliant, Power Output 15W per Port)	2/4 x RJ-45 GbE PSE (IEEE 802.3af compliant, Power Output 15W per Port)
I/O Interfaces	2 x I2C, 1 x SPI, 5 x GPIO, 2 x UART 1 x RS-232, 1 x RS-422 / RS-485 (2-in-1) 2 x CAN 2.0b w/ isolation 1 x microSIM Card Slot	
Expansion	1 x M.2 B-Key 3042/3052 (LTE/4G/5G) 1 x M.2 E-Key 2230 (WiFi/BT) 1 x M.2 M-Key 2280 (NVMe) 1 x microSD Card Slot	
MISC. Function	1 x Power / Recovery / Reset Button	
Power Input/Connector	DC-IN 9 to 36 VDC / 4-Pin DC Jack Power Connector	
Power Consumption	Idle: 7.5 W Full Loading: 109 W	Idle: 8 W Full Loading: 130 W

Idle: Connect with Keyboard, Mouse and HDMI Display

Full Loading: Connect with keyboard, mouse, HDMI display and LAN with CPU and GPU 100% loading

Dimension (W x D x H)	270 x 195 x 80 mm (10.63 x 7.67 x 3.15 in)
Mounting	Wall Mount / Din Rail (optional)
Net Weight	4.3 kg (9.48 lb)
Vibration	1 Grms, IEC 60068-2-64, random, 5 ~ 500 Hz, 1 hr/axis
Shock	10 G, IEC 60068-2-27, half sine, 11 ms duration
Temperature	Operating Temperature: -25°C ~ +55°C (-13°F ~ +131°F) Storage Temperature: -40°C ~ +85°C (-40°F ~ +185°F)
Humidity	95% @ 40°C (104°F) (non-condensing)
Certification	CE / FCC Class A / UKCA

2. Hardware Information

2.1 I/O Interface

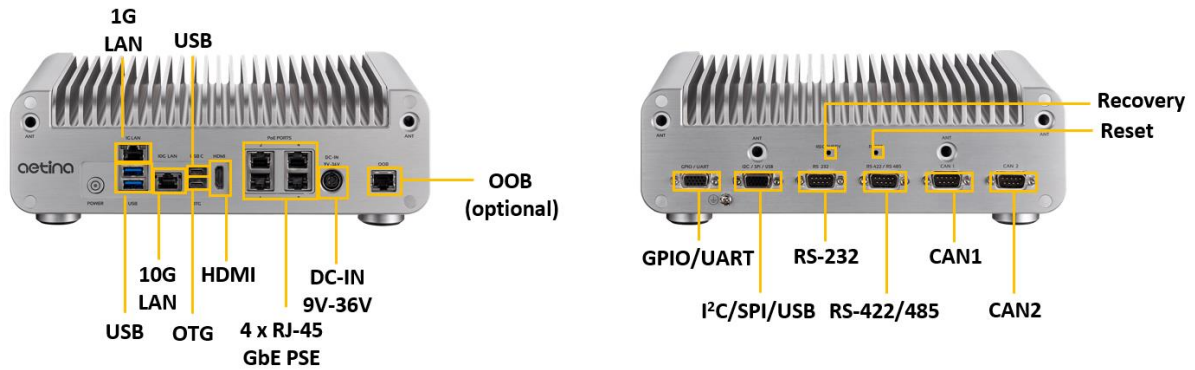

Figure 2.1 AIE-PX11/AIE-PX12/AIE-PX21/AIE-PX22 I/O Interface

2.2 External Connector Summary

Location	External Connector	Description
Front	Power	Power pushbutton
	DC IN	Power Connector 9V-36V
	10G LAN	10 GbE Port
	1G LAN	1 GbE Port
	PoE Ports	IEEE 802.3af GbE PSE ports x 4
	HDMI	HDMI Type-A female connector
	USB	USB3.2 Gen1 Type-A connector x 2
	USB C	USB3.2 Gen2 Type-C connector
Rear	OTG	OTG Type-C Port
	GPIO/UART	DB15 female connector
	I2C/SPI/USB	DB15 female connector
	RS-232	DB9 male connector
	RS-422/RS-485	DB9 male connector
	CAN1	DB9 male connector
	CAN2	DB9 male connector
	Recovery	Recovery pushbutton
	Reset	Reset pushbutton

2.2.1 Connector Interface

■ Power

Item	Description
Location	Front
Type	Pushbutton

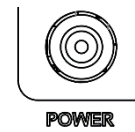

POWER

■ Power input connector

Item	Description
Location	Front
Type	9V to 36V 4-Pin DC Jack

DC-IN
9V-36V

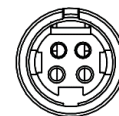

■ 1G LAN / 10G LAN

Item	Description
Location	Front
Type	RJ-45 Connector

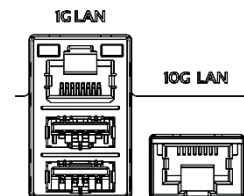

■ GbE PoE (Power over Ethernet)

Item	Description
Location	Front
Type	RJ-45 Connector
Notes	IEEE 802.3af compliant, Power Output 15W per Port

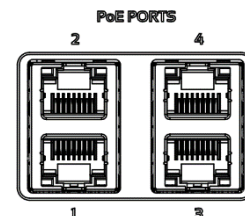

■ HDMI

Item	Description
Location	Front
Type	HDMI Type-A female connector



HDMI

■ Dual USB3.2 Gen1 Type-A connector

Item	Description
Location	Front
Type	Type-A USB connector
Pin	Refer to USB Standard

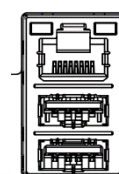

USB

■ Dual Type-C connector

Item	Description
Location	Front
Type	Type-C USB connector
Pin	Refer to USB Standard
Notes	OTG: OTG Type-C Port USB C: USB3.2 Type-C Port

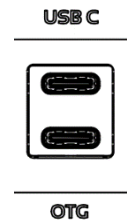

■ I2C / SPI / USB

Item	Description
Location	Rear
Type	DB15 female connector

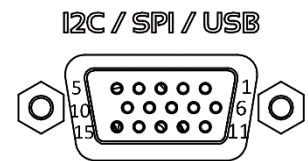

Pin #	Definition	Pin #	Definition
1	SPI_MOSI	2	SPI_SCK
3	SPI_MISO	4	SPI_CS1
5	SPI_CS0	6	I2C_1_CLK
7	I2C_1_DAT	8	I2C_2_CLK
9	I2C_2_DAT	10	3.3V
11	USB_DM	12	USB_DP
13	5V	14	GND
15	GND		

■ GPIO / UART

Item	Description
Location	Rear
Type	DB15 female connector



Pin #	Definition	Notes	Pin #	Definition	Notes
1	GPIO_1 (GPIO17 / PP.04 444)	IN/OUT	2	GPIO_2 (GPIO11 / PAC.05 491)	IN/OUT
3	GPIO_3 (PWM01 / PR.00 456)	IN/OUT	4	GPIO_4 (GPIO27 / PN.01 433)	IN/OUT
5	GPIO_5 (GPIO35 / PH.00 391)	IN/OUT	6	UART1_TX	
7	UART1_RX		8	UATR1_CTS	
9	UATR1_RTS		10	3.3V	
11	UATR2_RT		12	UATR2_TX	
13	5V		14	GND	
15	GND				

■ RS 422 / RS 485 (2-in-1)

Item	Description
Location	Rear
Type	RS-422/RS-485 (2-in-1)
Notes	Default setting is RS-485 mode (Data-/+)

RS 422 / RS 485

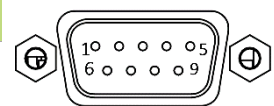

Pin #	Definition	Pin #	Definition
1	TxD+	2	TxD-
3	RxD-/Data-	4	RxD+/Data+
5	GND	6	NA
7	NA	8	NA
9	NA		NA

■ RS 232

Item	Description
Location	Rear
Type	RS-232

RS 232

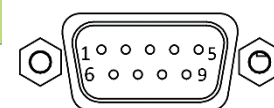

Pin #	Definition	Pin #	Definition
1	NA	2	RX
3	TX	4	NA
5	GND	6	NA
7	RTS	8	CTS
9	NA		

■ CAN1

Item	Description
Location	Rear
Type	DB9 male connector

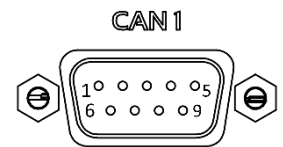

Pin #	Definition	Pin #	Definition
1	NA	2	CAL_L
3	GND	4	NA
5	NA	6	NA
7	CAL_H	8	NA
9	NA		

■ CAN2

Item	Description
Location	Rear
Type	DB9 male connector

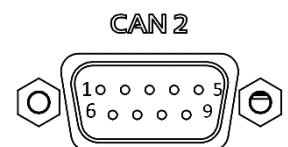

Pin #	Definition	Pin #	Definition
1	NA	2	CAL_L
3	GND	4	NA
5	NA	6	NA
7	CAL_H	8	NA
9	NA		

■ Reset & Recovery Button

Item	Description	RECOVERY ○	RESET ○
Location	Rear		
Type	Pushbutton		

2.3 Power Consumption

The power consumption shown as below is the theoretical value with AGX Orin module installed on AIE-PX11

Type	Theoretical Maximum System power
Idle	7.5 W (Connect with Keyboard, Mouse and HDMI Display)
Full Loading	79 W (Connect with Keyboard, Mouse, HDMI Display, LAN and 2 PSE ports with CPU And GPU 100% Loading)

AIE-PX12

Type	Theoretical Maximum System power
Idle	7.5 W (Connect with Keyboard, Mouse and HDMI Display)
Full Loading	109 W (Connect with Keyboard, Mouse, HDMI Display, LAN and 4 PSE ports with CPU And GPU 100% Loading)

AIE-PX21

Type	Theoretical Maximum System power
Idle	8 W (Connect with Keyboard, Mouse and HDMI Display)
Full Loading	100 W (Connect with Keyboard, Mouse, HDMI Display, LAN and 2 PSE ports with CPU And GPU 100% Loading)

AIE-PX22

Type	Theoretical Maximum System power
Idle	8 W (Connect with Keyboard, Mouse and HDMI Display)
Full Loading	130 W (Connect with Keyboard, Mouse, HDMI Display, LAN and 4 PSE ports with CPU And GPU 100% Loading)

Please refer to the following power consumption of individual I/O interface according to your use case.

Type	Theoretical Maximum System power
USB 3.2 Gen1 Type A (per Port)	4.5 W
USB Type C	4.5 W
HDMI	0.25 W
M.2 E KEY	2 W
M.2 M KEY	7 W
M.2 B KEY	3 W
CAN Bus	1 W
SD Card	0.72 W
RJ45(1G)	0.83 W
RJ45(10G)	3.43 W
PoE (per Port)	15 W (IEEE 802.3af compliant)

2.4 Mechanical Dimensions

■ System & Mounting Dimensions

Integration assembly drawing for AIE-PX11/ AIE-PX12/ AIE-PX21/ AIE-PX22 system.

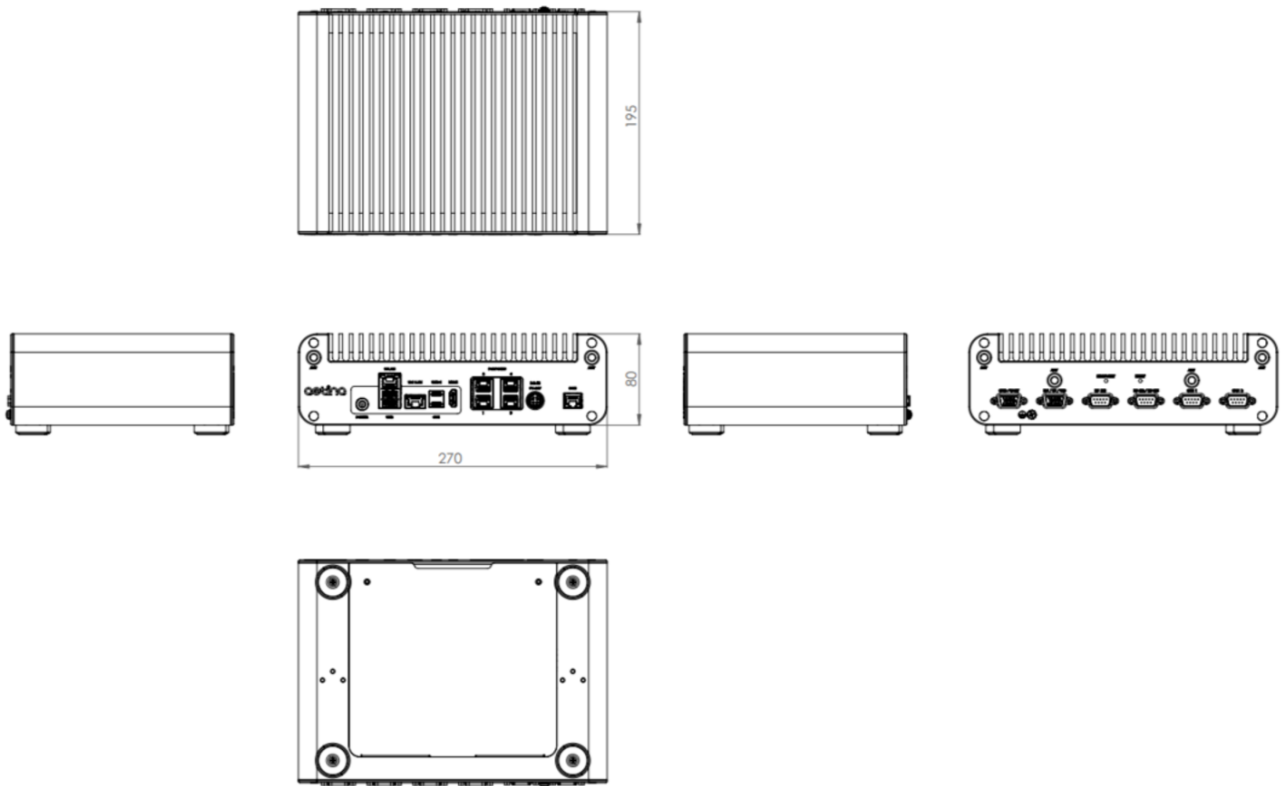

3. Software Installation

Aetina NVIDIA Jetson products have built-in BSP so the users don't have to install it after getting the products. Since we develop our own BSP, the users may need to follow the BSP installation SOP to re-install/upgrade/downgrade the BSP. Please visit the Aetina website or contact with Aetina FAE at Tech_support@aetina.com for installation guides, BSPs and technical tips.

4. Recovery Mode

The USB2.0 Type-C (support OTG) port of AIE-PX11/ AIE-PX12/ AIE-PX21/ AIE-PX22 can be connected to another host device (Linux PC running NVIDIA Jetpack™) to run recovery process for re-flashing BSP.

Note: Please backup user personal files before flashing process

Step 1: Connect the OTG USB port to another host device which supplying updated BSP file.

Step 2: Press and hold the Reset button, then press and hold the Recovery button continually.

Step 3: After one second (1 sec.) release the Reset button first, then release the Recovery button.

Step 4: The AGX Orin will show up as a new NVIDIA device on USB list (Terminal console) at the host device.

Step 5: Running re-flashing BSP process can be executed by the host device now.

5. Initial Setup

Before using AIE-PX11/ AIE-PX12/ AIE-PX21/ AIE-PX22, please follow the steps below to have initial setup.

5.1 Prepare the Materials

Please prepare the materials list below.

- A monitor with HDMI and respective cables
- USB keyboard and mouse
- Ethernet cable

5.2 Hardware Connection

Here is the AIE-PX11/ AIE-PX12/ AIE-PX21/ AIE-PX22 below and for the initial setup, users will need to connect LAN port, keyboard and mouse via USB interface, HDMI interface, and power connector.

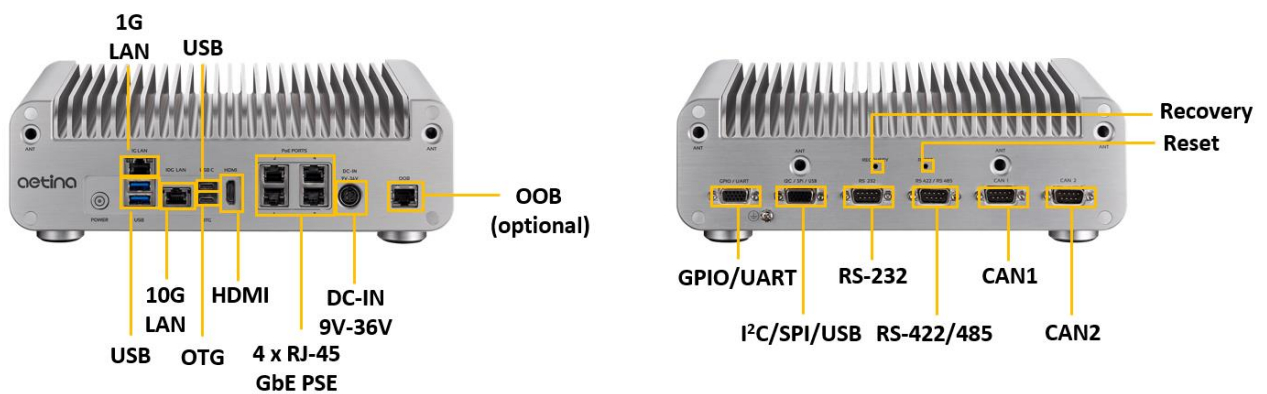

5.3 Setup Details

1. Connect to the monitor while powering off
2. Power on and automatically enter the OS
3. Log in to the Ubuntu OS via credentials below

Username: nvidia

Password: nvidia

For more information on how to use Ubuntu and NVIDIA Jetson modules, please visit Ubuntu and NVIDIA website.

6. EdgeEye

6.1 Aetina Edge Administration Platform

Introduction

To help clients efficiently and systematically manage edge devices deployed in different locations, Aetina offers several cloud management platforms. For example, EdgeEye, an Aetina browser-accessed management platform, allows clients to conveniently manage edge devices via intranet-connected cell phones, tablets, or laptops, no matter where the devices are deployed. It shows diversified status of devices with user-friendly interfaces to help clients check if user-defined values are in the normal range, including CPU/GPU loading and temperature, memory loading, storage status, deployment sites, and unsolved events setting. In addition, EdgeEye supports functions of reboot, shutdown, backup, and recovery via out-of-band management modules, especially when clients are intuitively aware of abnormal charts on the dashboard.

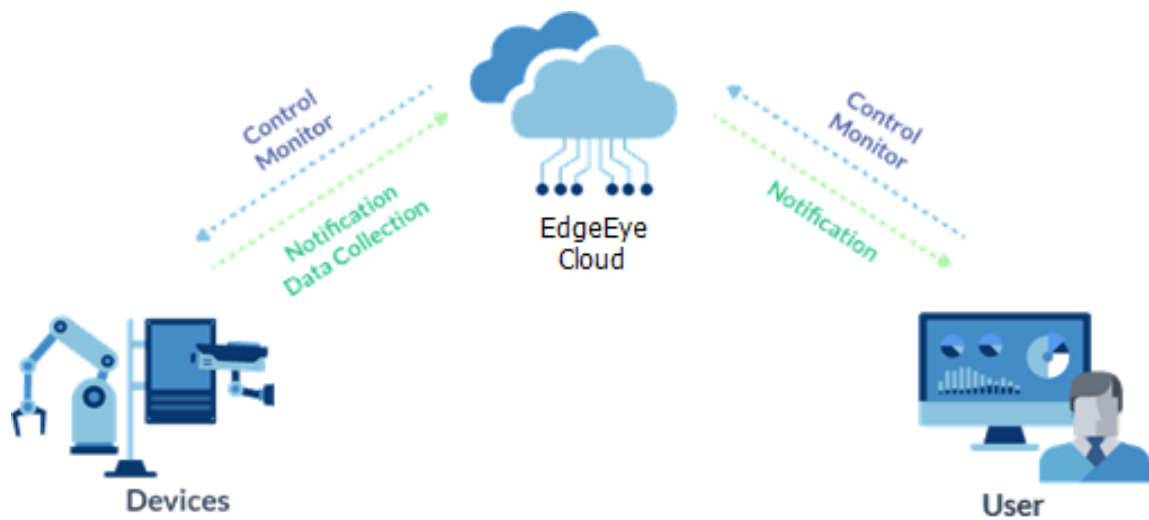

6.2 Feature

Edge Device Management

Monitor edge devices' hardware status, such as CPU, GPU, Memory' s utilization and capacity.

Alert Notification

Customized alert threshold and when getting abnormal data from edge devices, send warning notification immediately.

Remote Controlling

Reboot and shut down edge device through the operating system's command from server when needs.

User-Friendly Operation Interface

User can set and arrange monitoring data format by their needs.

Group devices control and Scheduler

6.3 System Requirements

Web Service

Web browsers support HTML5, CSS3, JavaScript

Microsoft Edge: 103.0+

Google Chrome:9.0+

Firefox:15.0+

Safari:5.1+

Server

Hardware Minimum Requirements:

Intel® Core™ i5 2.3 Ghz CPU or above

32 GB RAM

200 GB root partition for the system

Operating System:

Linux Ubuntu 20.04+

Browser:

Google Chrome 9.0+

Client

Support all Aetina products



Aetina Corporation | Headquarters

2F-1, No.237, Sec.1, Datong Rd., Xizhi Dist., New Taipei City 221, TAIWAN

Phone: +886-2-7709 2568

Fax : +886-2-7746 1102

Mail : sales@Aetina.com

www.Aetina.com