

LE-37N

3.5 inch Motherboard

User's Manual

Edition 1.1
2019/08/15

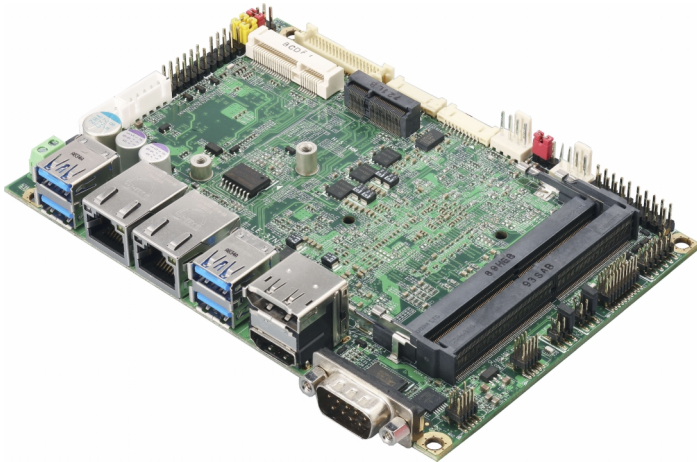

Copyright

Copyright 2019, all rights reserved. This document is copyrighted and all rights are reserved. The information in this document is subject to change without prior notice to make improvements to the products.

This document contains proprietary information and protected by copyright. No part of this document may be reproduced, copied, or translated in any form or any means without prior written permission of the manufacturer.

All trademarks and/or registered trademarks contains in this document are property of their respective owners.

Disclaimer

The company shall not be liable for any incidental or consequential damages resulting from the performance or use of this product.

The company does not issue a warranty of any kind, express or implied, including without limitation implied warranties of merchantability or fitness for a particular purpose.

The company has the right to revise the manual or include changes in the specifications of the product described within it at any time without notice and without obligation to notify any person of such revision or changes.

Trademark

All trademarks are the property of their respective holders.

Any questions please visit our website at <http://www.commell.com.tw>

Packing List:

Please check the package content before you starting using the board.



1 x LE-37N 3.5 inch Miniboard



1 x Cooler Fan
(OHSF-37N / 2181010035)



1 xDC Input Power Cable
(OALDC-B / 1040513)



1 x SATA Power Cable
(OALSATA15-2PJ / 1040613)



1 x SATA CABLE
(OALSATA3-H10-L35 / 1040523)

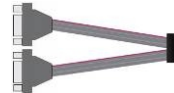

1 x Dual COM cable
(OALES-BKU2NB / 1040090)



1 x Audio cable
(OALPJ-HDUNB / 1040123)



1 x PS/2 Keyboard & Mouse cable
(OALPS2/KM / 1040131) (Optional)

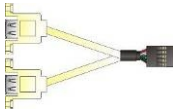

1 xUSB2.0 cable
(OALUSBA-3 / 1040173) (Optional)



1 x COM Cable
(OALES-BKU1NB / 1040086) (Optional)



1 x Driver CD
(Including User's Manual)

Index

Chapter 1 <Introduction>	4
1.1 <Product Overview>.....	4
1.2 <Product Specification>	5
1.3 <Block Diagram>.....	6
Chapter 2 <Hardware setup>	7
2.1 <Connector Location and Reference>	7
2.1.1 <Internal connectors list>.....	8
2.1.2 <External connectors list>.....	8
2.2 <Jumper Location and Reference>	9
2.2.1 <Jumper list>	9
2.2.2 <Clear CMOS and Power on type selection>.....	10
2.3 <Installing the Memory>	11
2.4 <I/O interface>	12
2.4.1 <Serial ATA interface>	12
2.4.2 <Ethernet interface>.....	12
2.4.3 <Display interface>	13
2.4.4 <Serial Port interface>	15
2.4.5 <USB interface>.....	17
2.4.6 <Audio interface>.....	18
2.4.7 <Expansion slot>.....	19
2.4.8 <Front panel switch and indicator>	20
2.4.9 <GPIO ,SMBus and Other Interface>.....	21
2.5 <Power supply>	24
2.5.1 <Power input>.....	24
2.5.2 <Power output>.....	24
Appendix A <Flash BIOS>	25
Appendix B <LCD Panel Type select>	26
Appendix C <Programmable Watch Dog Timer>	28
Appendix D <Hardware Monitor>	30
Appendix E <Programmable GPIO>	31
Appendix F <RAID Setting>	32
Appendix G <Setup ADP-3355,ADP-3460>	33
Contact information	33

Chapter 1 <Introduction>

1.1 <Product Overview>

LE-37N is a 3.5" Motherboard which supports 8th Generation Intel® Core™ U-Series processors, integrated HD Graphics, DDR4 memory, Realtek High Definition Audio, Intel Gigabit LAN, USB3.1 Gen2, SATA3 with AHCI function for a system.

New feature for Whiskey Lake

Whiskey Lake-U processors are based on the 14nm++ process node, and offer long-life availability. They have a TDP of 15W, and integrate Gen 9.5 Intel Graphics GT2. It allows triple independent display with 4K resolution.

All in One multimedia solution

The board provides high performance onboard graphics, and supports single bus or dual bus LVDS signaling with color depths of 18 bits or 24 bits, DisplayPort, HDMI, and High Definition Audio, to meet the very requirement of the multimedia application.

Flexible Expansion Interface

The board provides one MiniPCIe slot(support mSATA), and one M.2 2230 slot.

Whiskey Lake support Windows10 64bit RS5 and Linux

Intel recommend using Windows 10 64bit RS5. It may lose some drivers if you use other Windows version.

1.2 <Product Specification>

System

Processor	Intel® Whiskey Lake Processor FCBGA1528 package
Memory	2 x DDR4 SO-DIMM 2400 MHz up to 32GB, Support Non-ECC, unbuffered memory
Watchdog Timer	Generates a system reset with internal timer for 1min/s ~ 255min/s
Real Time Clock	Chipset integrated RTC with onboard lithium battery
Expansion	1 x MiniPCIe (support mSATA) 1 x M.2 (Key E) for Wi-Fi and Bluetooth 2230mm

Graphics

Chipset	Intel® Gen 9.5 integrated HD Graphics
Display Interface	1 x DisplayPort(optional), 1 x HDMI, 1 x LVDS

LAN

Chip	1 x Intel® I210-AT Gigabit LAN 1 x Intel® I219-LM Gigabit PHY LAN (Support iAMT12.0)
------	---

I/O

Serial ATA	2 x SATA3
Audio	Realtek ALC262 HD Audio
Digital I/O	Programmable 8-bit GPIO with 12 pin-header
Internal I/O	2 x SATA3, 4 x USB2.0, 1 x RS232, 2x RS232/485/422 1 x LVDS, 1 x LCD inverter, 1 x GPIO, 1 x Audio, 1 x PS/2, 1 x SMBus
Rear I/O	1 x DisplayPort(optional), 1 x HDMI, 4 x USB3.1 Gen2, 2 x LAN 1 x RS232

Mechanical & Environmental

Power Requirement	DC input 9~35V
Size	146mm x 101mm (L x W)
Temperature	Operating within 0°C~60°C (32°F~140°F) Storage within -20°C~80°C (-4°F~176°F)
Relative Humidity	10%~90%, non-condensing

1.3 <Block Diagram>

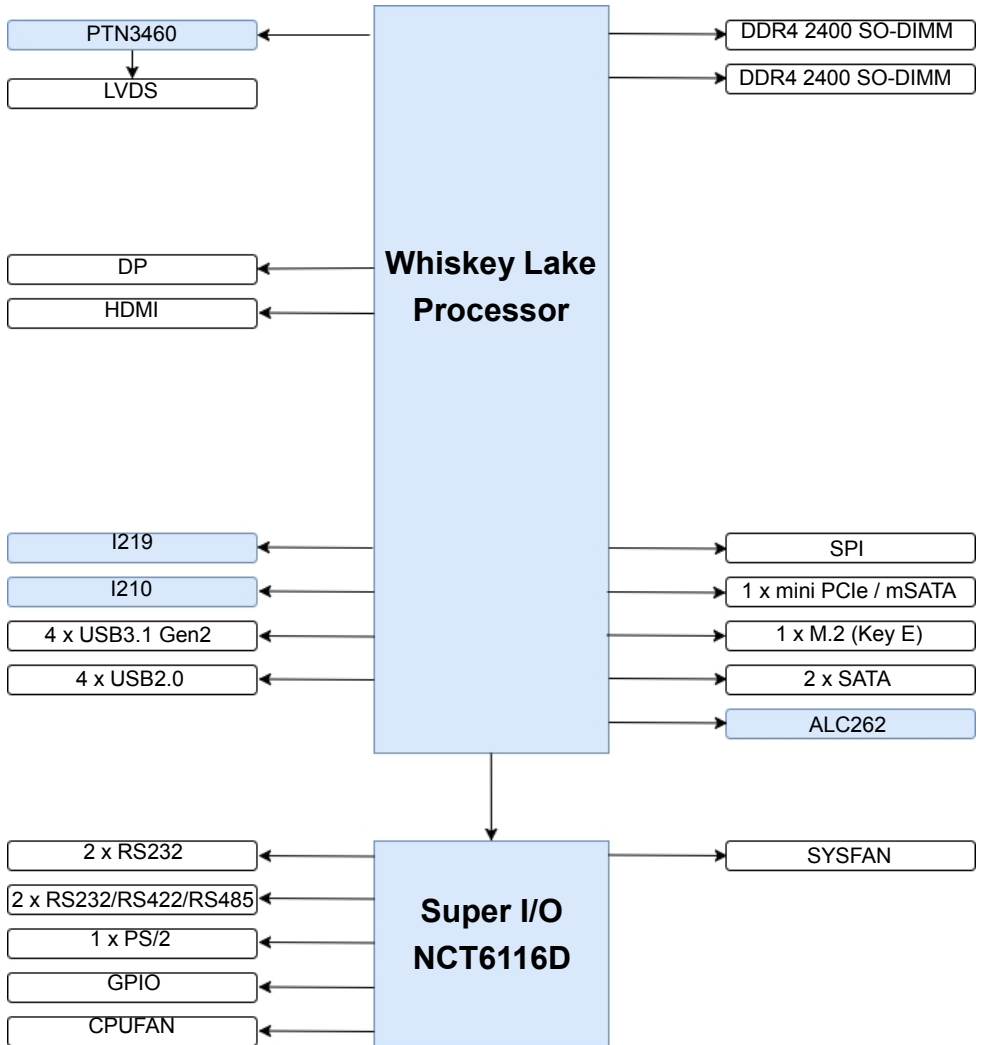

Chapter 2 <Hardware setup>

2.1 <Connector Location and Reference>

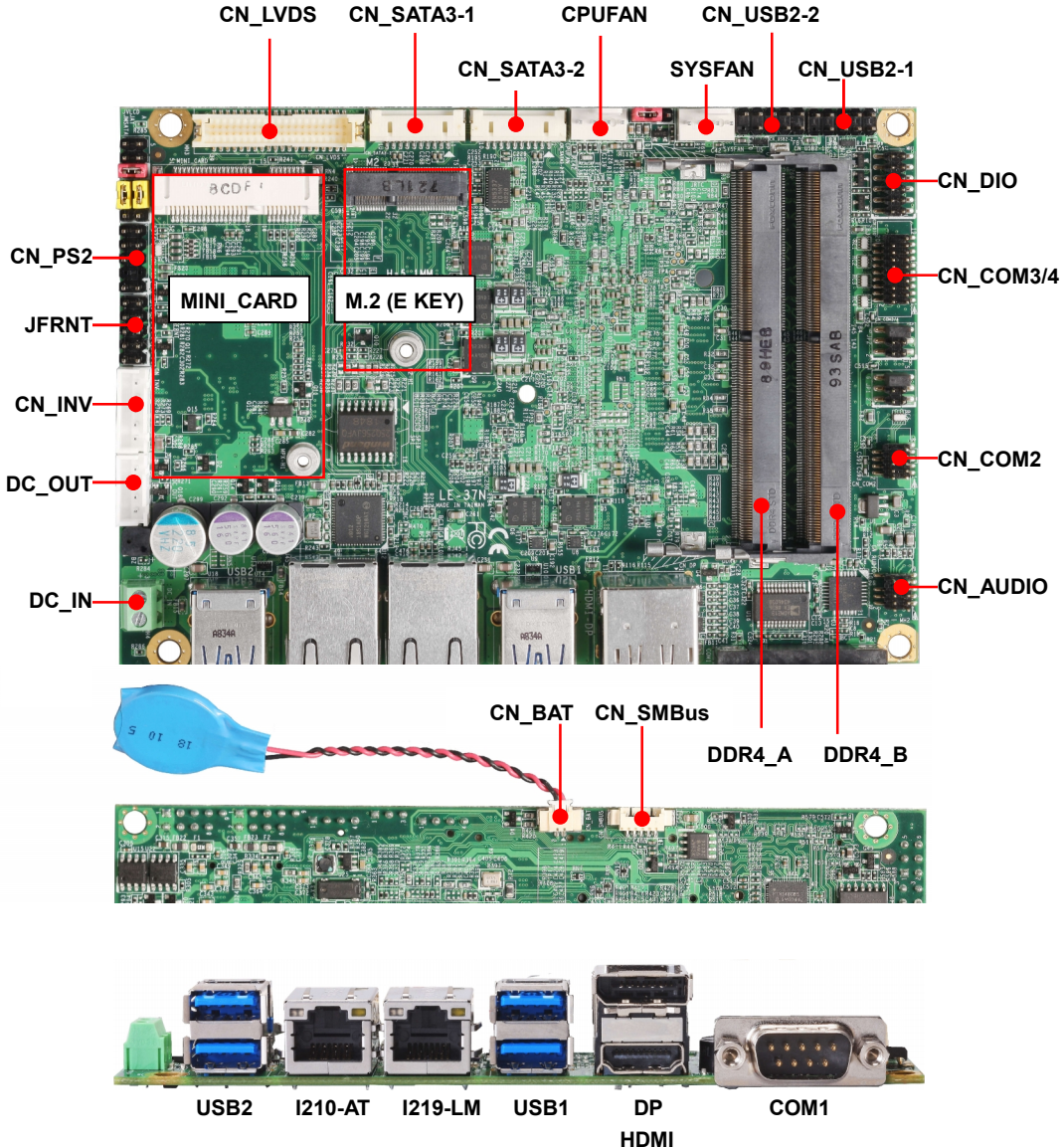

2.1.1 <Internal connectors list>

Connector	Function
SO-DIMM	260-pin DDR4 SO-DIMM slot
CN_SATA3-1/2	10-pin Serial ATA3 connector
CN_AUDIO	5 x 2-pin audio pin header
CN_DIO	6 x 2-pin General Purpose In/Out pin header
CN_LVDS	20 x 2-pin LVDS connector
CN_DP	11 x 1-pin DP to VGA module connector for optional
CN_INV	5-pin LCD inverter connector
CN_COM2	5 x 2-pin RS232 connector
CN_COM3/4	20-pin RS232/422/485 connector
CN_USB1/2	5 x 2-pin USB2.0 pin header
CN_PS2	5 x 2-pin PS/2 pin header
CN_SMBus	5-pin SMBus connector
CPUFAN	4-pin CPU fan connector
SYSFAN	4-pin System fan connector
JFRNT	5 x 2-pin front panel switch/indicator pin header
MINI_CARD	52-pin MiniPCIe card slot
M2	75-pin M.2 Key E slot
DC_OUT	4-pin SATA Power connector
DC_IN	2-pin power input Terminal Block

2.1.2 <External connectors list>

Connector	Function
COM1	DB9 connector
HDMI-DP	DisplayPort and HDMI dual layer connector
USB1	2 x USB3.1 Gen2 connector
USB2	2 x USB3.1 Gen2 connector
LAN1	RJ45 connector
LAN2	RJ45 connector

2.2 <Jumper Location and Reference>

2.2.1 <Jumper list>

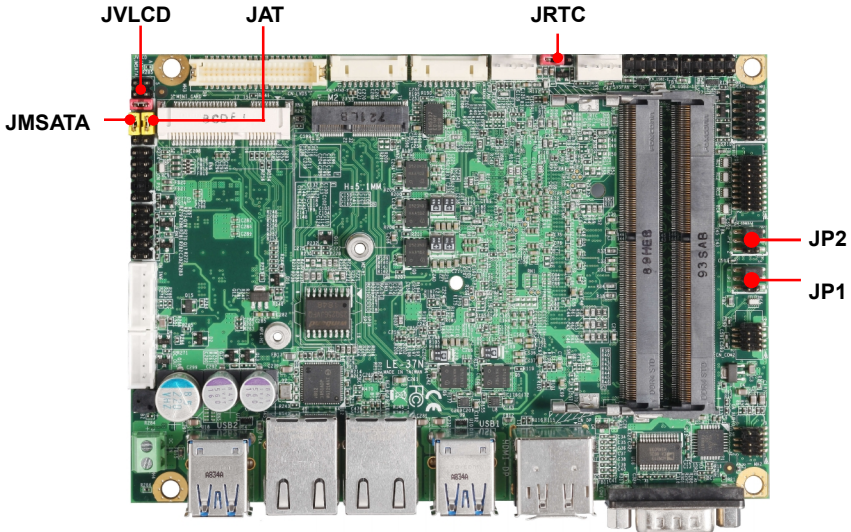

Jumper	Function
JAT	Power mode select
JRTC	CMOS Normal/Clear Setting
JVLCD	Panel Voltage Setting
JMSATA	MiniCard mSATA Setting
JP1/2	COM1 and CN_COM2 9-pin setting

2.2.2 <Clear CMOS and Power on type selection>

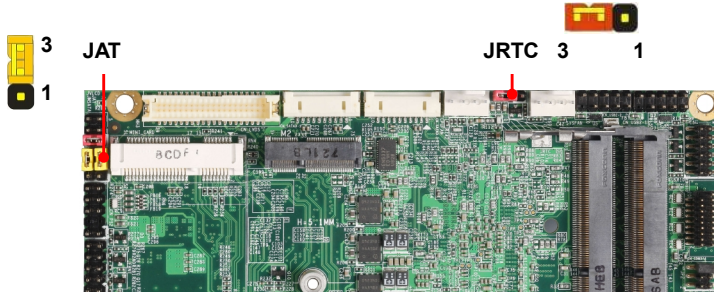

JRTC: Clear CMOS data jumper

Jumper settings	Function
1-2	Clear CMOS
2-3	Normal (Default)

JAT: AT/ATX mode select jumper

Jumper settings	Function
1-2	AT mode
2-3	ATX mode (Default)

2.3 <Installing the Memory>

LE-37N has 260-pin DDR4 SODIMM support up to 32GB of memory capacity and 1.2 Voltage. The memory frequency supports 2400 MHz. Only Non-ECC memory is supported.

In the process, the board must be powered off.

1. Put the memory tilt into the slot. Note the Memory notch key aligned slot key.
2. Then press down till lock into the mounting notch.

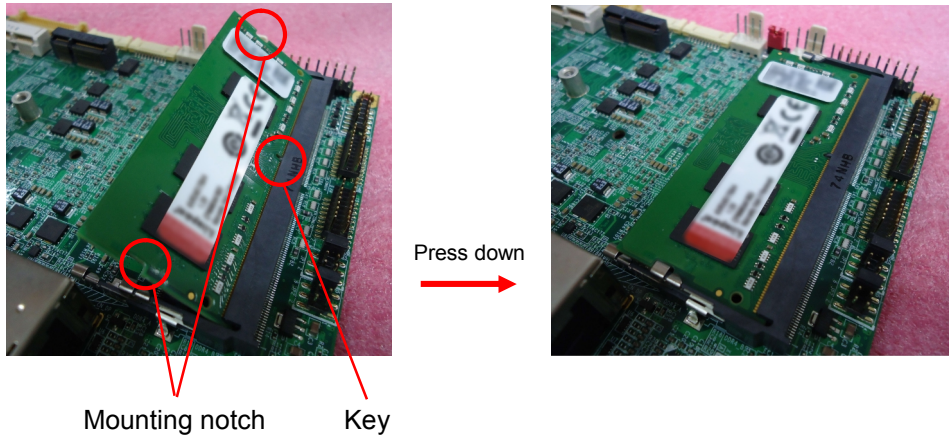

3. To remove the memory, push outward on both sides of the latch.

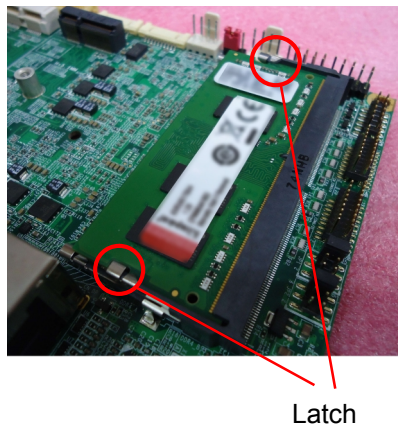

2.4 <I/O interface>

2.4.1 <Serial ATA interface>

Support RAID0 and 1.

CN_SATA3-1/2: SATA3 10-pin connector

Pin	Signal
1	GND
2	TX+
3	TX-
4	GND
5	NA
6	NA
7	GND
8	RX-
9	RX+
10	GND

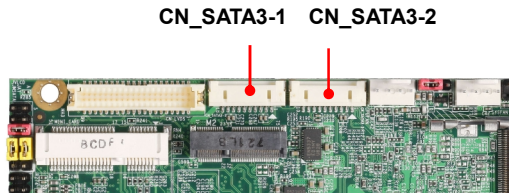
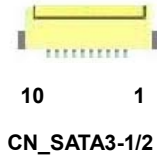

2.4.2 <Ethernet interface>

The board provides I210-AT and I219-LM Gigabit Ethernet which supports WOL on rear I/O.

It supports Intel® AMT 12.0 feature on I219-LM.

(Note that the CPU must support vPro technology.)

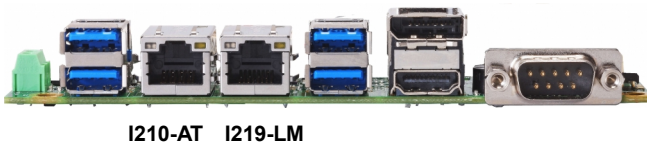

2.4.3 <Display interface>

Based on the 8th Gen CPU with built-in HD Graphics, the DisplayPort resolution up to 3840x2160 @ 60Hz or 4096x2304 @ 60Hz, the HDMI up to 4096x2304 @ 24Hz and LVDS up to 1920x1200 @ 60Hz supports single bus or dual bus LVDS signaling with color depths of 18 bits or 24 bits. About select LCD Panel Type in BIOS, please refer **Appendix C**.

The built-in HD Graphics support triple display function with clone mode and extended mode.

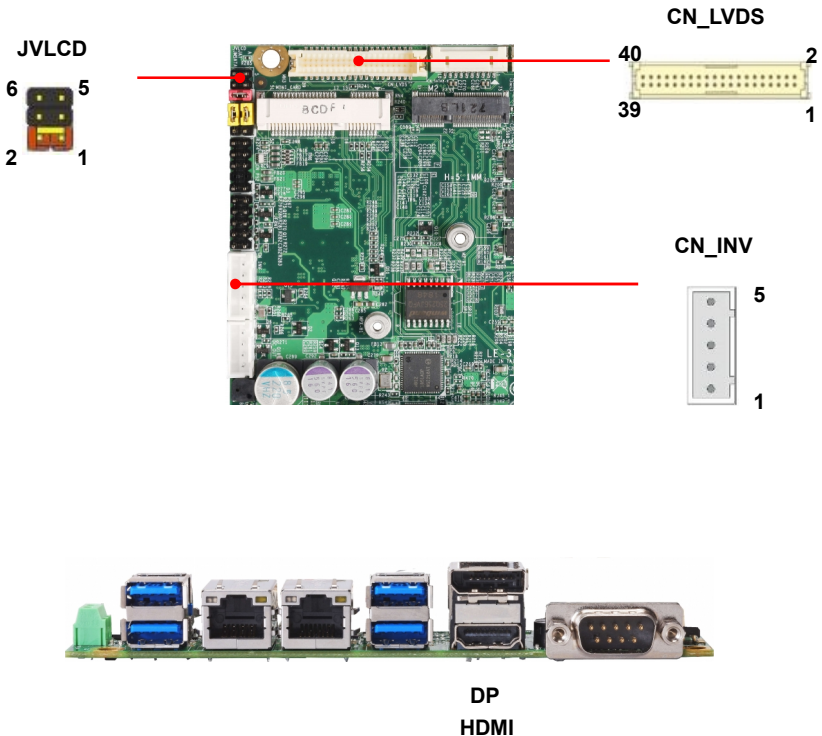

- Note: 1. The HDMI-DP dual layer connector can be changed HDMI & CN_DP, CN_DP function for use “ADP-3355” VGA module.
 (The VGA resolution is up to 2048x1536 @50Hz.)
2. ADP-3355 no need install extra driver. Here is Setup manual [Link](#).

CN_LVDS: LVDS 40-pin connector (Model: HIROSE DF13-40DP-1.25V compatible)

Pin	Signal	Pin	Signal
2	Set by JVLCD	1	Set by JVLCD
4	Detect (Active low)	3	GND
6	A_LVDS_0-	5	B_LVDS_0-
8	A_LVDS_0+	7	B_LVDS_0+
10	GND	9	GND
12	A_LVDS_1-	11	B_LVDS_1-
14	A_LVDS_1+	13	B_LVDS_1+
16	GND	15	GND
18	A_LVDS_2-	17	B_LVDS_2-
20	A_LVDS_2+	19	B_LVDS_2+
22	GND	21	GND
24	A_LVDS_CLK-	23	B_LVDS_3-
26	A_LVDS_CLK+	25	B_LVDS_3+
28	GND	27	GND
30	A_LVDS_3-	29	B_LVDS_CLK-
32	A_LVDS_3+	31	B_LVDS_CLK+
34	GND	33	GND
36	LVDS_DDCSCL	35	NC
38	LVDS_DDCSDA	37	NC
40	NC	39	NC

Note: Pin4 only need to be connected to GND

CN_INV: LVDS 5-pin Backlight power connector

Pin	Signal
1	12V
2	Backlight Control
3	GND
4	GND
5	Enable Backlight

JVLCD: LVDS panel power select jumper

Jumper settings	Function
1-2	3.3V (Default)
3-4	5V
5-6	12V

Effective patterns of connection: 1-2 / 3-4 / 5-6
Other may cause damage

2.4.4 <Serial Port interface>

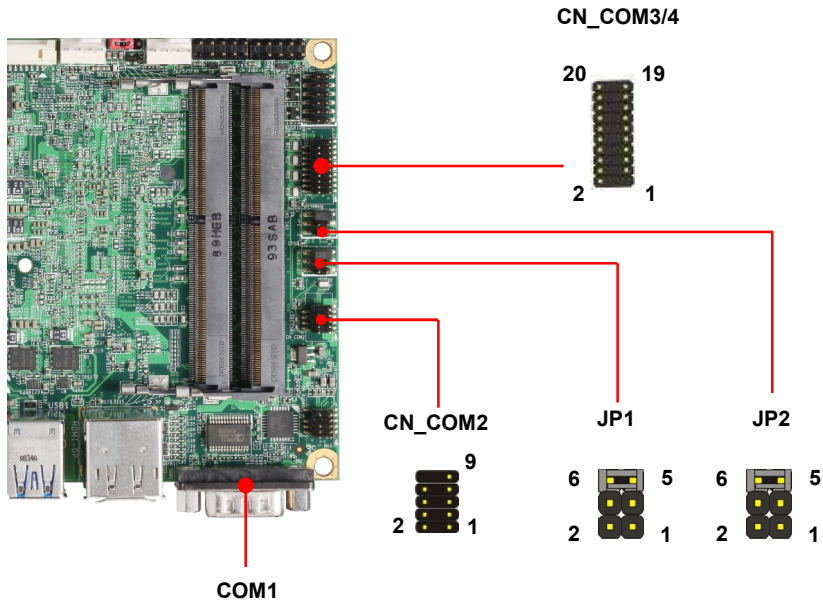

COM1: RS232 DB9 connector

Pin	Signal	Pin	Signal
1	DCD	2	RXD
3	TXD	4	DTR
5	GND	6	DSR
7	RTS	8	CTS
9	Set by JP1	10	Key

CN_COM2: RS232 10-pin header (Pitch 1.27mm x 2.54mm)

Pin	Signal	Pin	Signal
1	DCD	2	RXD
3	TXD	4	DTR
5	GND	6	DSR
7	RTS	8	CTS
9	Set by JP2	10	Key

COM3/4: RS232/422/485 20-pin header (Pitch 2.54 x 1.27mm)

Pin	Signal	Pin	Signal
1	DCD1/ 422TX-/ 485-	2	RXD1/ 422TX+/ 485+
3	TXD1	4	DTR1
5	GND	6	DSR1/ 422RX+
7	RTS1	8	CTS1/ 422RX-
9	RI1	10	NC
11	DCD2/ 422TX-/ 485-	12	RXD2/ 422TX+/ 485+
13	TXD2	14	DTR2
15	GND	16	DSR2/ 422RX+
17	RTS2	18	CTS2/ 422RX-
19	RI2	20	Key

COM3/4 RS-232/422/485 can set by BIOS.

You can find the setting from

On **Front Page** screen, click Setup Utility

On **Advanced** screen, click Super IO Configuration

Then click RS232/RS422/RS485 Setting

RS232/RS422/RS485 Setting		
Input/Output mode	Input	Disable
	Output	Enable RS232/RS422/RS485 Setting
GPIO Output Potential	High	RS422/RS485
	Low	RS232 (Default)

CN_COM3/4 RTX- Data- : short Pin1& Pin8

CN_COM3/4 RTX+ Data+ : short Pin2& Pin6

CN_COM3/4 RTX- Data- : short Pin11& Pin18

CN_COM3/4 RTX+ Data+ : short Pin12& Pin16

JP1, JP2: COM1, COM2 pin-9 setting

Jumper settings	Function
1-2	5V
3-4	12V
5-6	RI (Default)

Effective patterns of connection: 1-2 / 3-4 / 5-6

Other may cause damage

2.4.5 <USB interface>

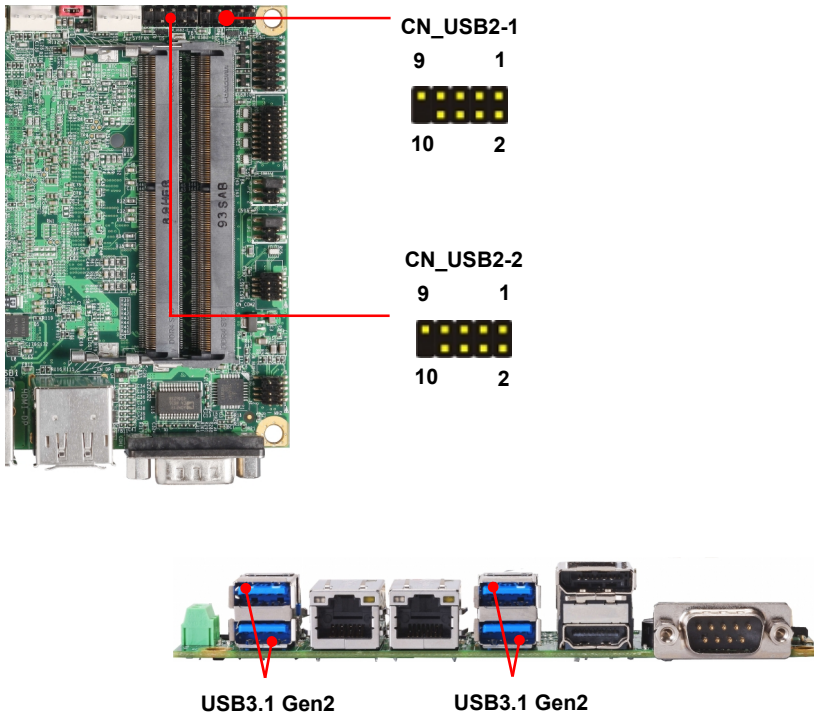

CN_USB2-1/2: Front panel USB2.0 10-pin header (Pitch 2.54mm)

Pin	Signal	Pin	Signal
1	5VSB	2	5VSB
3	DATA0-	4	DATA1-
5	DATA0+	6	DATA1+
7	GND	8	GND
9	GND	10	Key

2.4.6 <Audio interface>

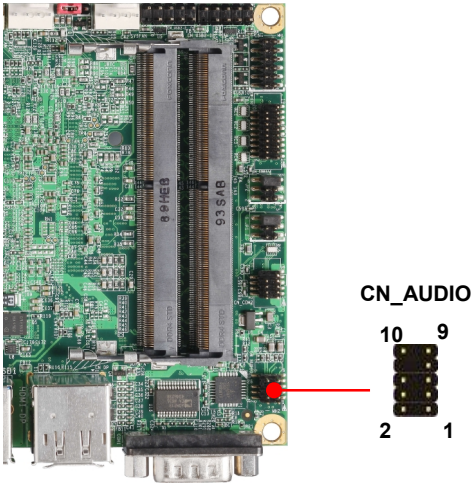

CN_AUDIO: Front panel audio 10-pin header (Pitch 1.27mm x 2.54mm)

Pin	Signal	Pin	Signal
1	MIC_L	2	GND
3	MIC_R	4	NC
5	FP_OUT_R	6	MIC_DETECT
7	SENSE	8	Key
9	FP_OUT_L	10	FP_OUT_DETECT

2.4.7 <Expansion slot>

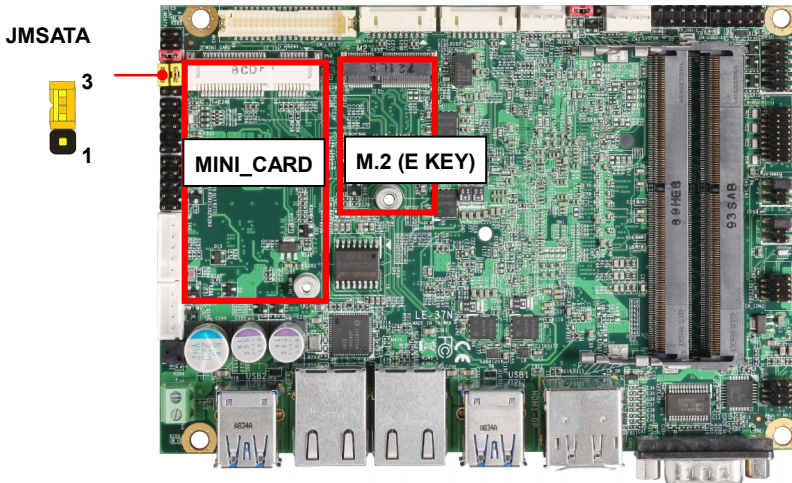

MINI_CARD has some special design to compatible our mini-PCIe card.

MINI_CARD supports mSATA by JMSATA

M2 (Key E) with 2x PCI Express x1 support WI-FI and Bluetooth Module

JMSATA: Setting MINI_CARD to support PCIe/mSATA

Jumper settings	Function
1-2	Support mSATA
2-3	Normal operation (Default)

2.4.8 <Front panel switch and indicator>

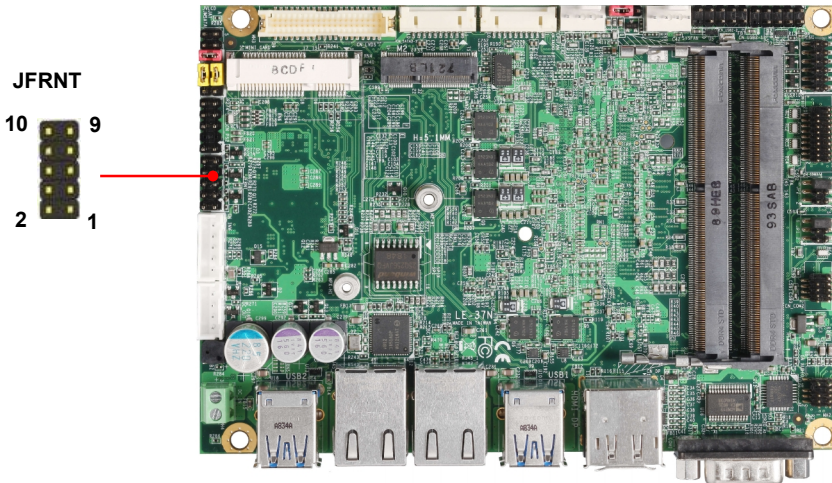

JFRNT: Front panel switch and indicator 10-pin header

Pin	Signal	Pin	Signal
1	Power_ON-	2	Power_ON+
3	Speaker-	4	Speaker+
5	HDD_LED-	6	HDD_LED+
7	Power_LED-	8	Power_LED+
9	Reset+	10	Reset-

2.4.9 <GPIO ,SMBus and Other Interface>

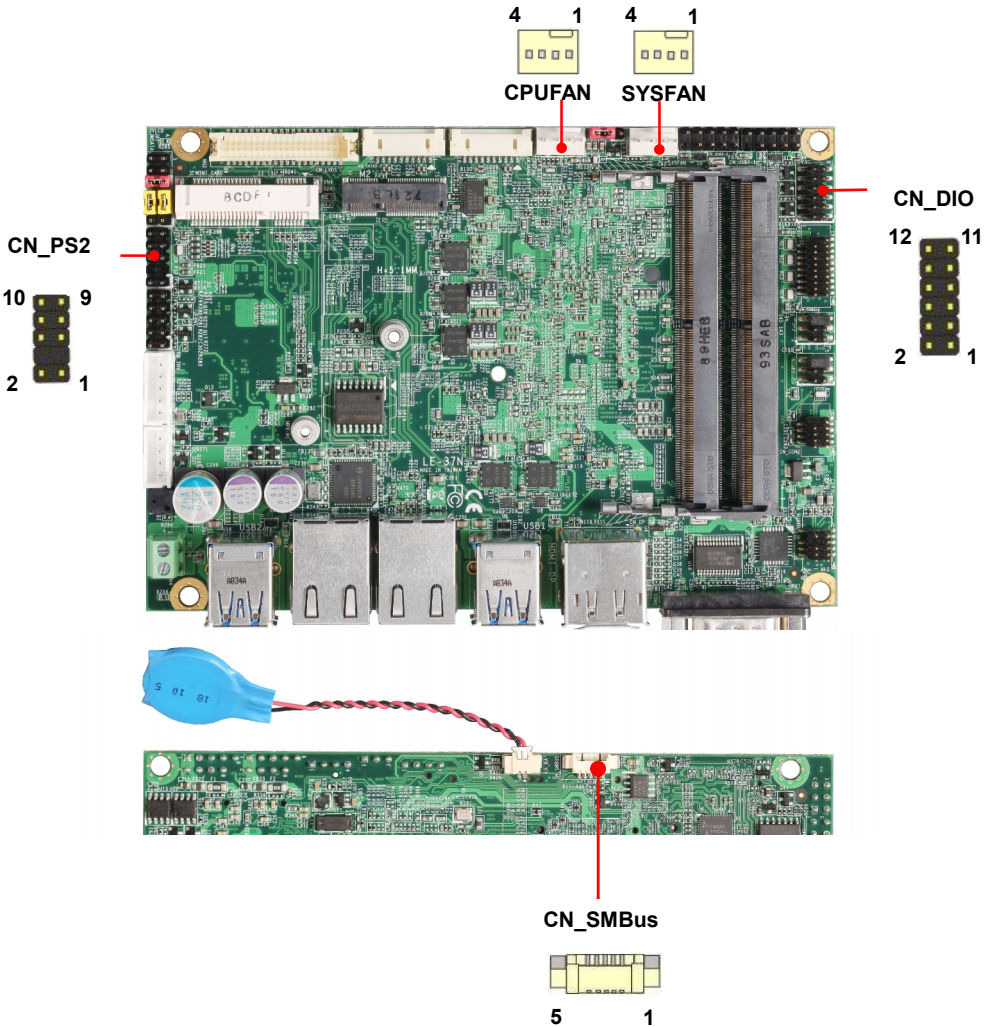

When using GPIO function

Press Delete to enter BIOS Setup menu

On **Front Page** screen, click Setup Utility

On **Advanced** screen, click Super IO Configuraion, then click GPIO 4 Configuration



Internal Resistance: Select output type, Push pull or Open drain

Input/Output mode: Select GPIO pin mode, Input or Output

GPIO Output Potential: GPIO output value.

As Input: **TTL-level**.

GPIO DC characteristics (open drain mode)

Parameter	SYM	MIN	TYP	MAX	UNIT	Conditions
Input Low Voltage	V _{IL}			0.8	V	
Input High Voltage	V _{IH}	2.0			V	
Output Low Voltage	V _{OL}			0.4	V	I _{OL} =12mA
Input High Leakage	I _{LIH}			+10	μA	V _{IN} =3.3V
Input Low Leakage	I _{LIL}			-10	μA	V _{IN} =0V

Please refer to **Appendix E** to program the configuration register

CN_DIO: GPIO 12-pin header (Pitch 2.00mm)

Pin	Signal	Pin	Signal
1	GND	2	GND
3	GPIO0	4	GPIO4
5	GPIO1	6	GPIO5
7	GPIO2	8	GPIO6
9	GPIO3	10	GPIO7
11	5V	12	12V

CN_SMBus: SMBus 5-pin connector

Pin	Signal
1	5V
2	NC
3	SMBDAT
4	SMBCLK
5	GND

CPUFAN: CPU cooler fan 4-pin connector

Pin	1	2	3	4
Signal	GND	12V	Sensor	Control

SYSFAN: System cooler fan 4-pin connector

Pin	1	2	3	4
Signal	GND	12V	Sensor	Control

CN_PS/2: PS/2 10-pin header (Pitch 2.54mm)

Pin	Signal	Pin	Signal
1	KB_DATA	2	M_DATA
3	NC	4	NC
5	GND	6	GND
7	VCC	8	VCC
9	KB_CLK	10	M_CLK

2.5 <Power supply>

2.5.1 <Power input>

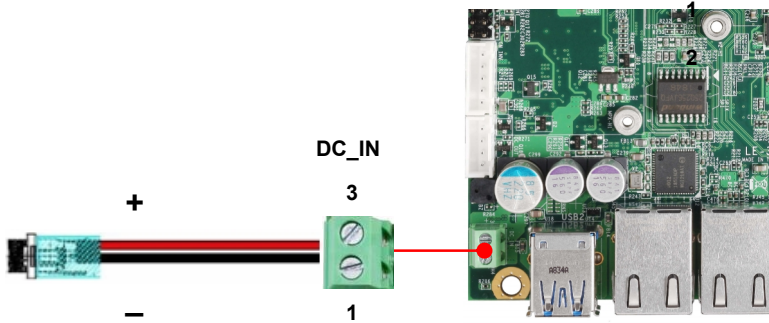

DC_IN: Terminal block 2-pin power connector

Pin	Signal	Pin	Signal
1	GND	2	9~35V Power input

2.5.2 <Power output>

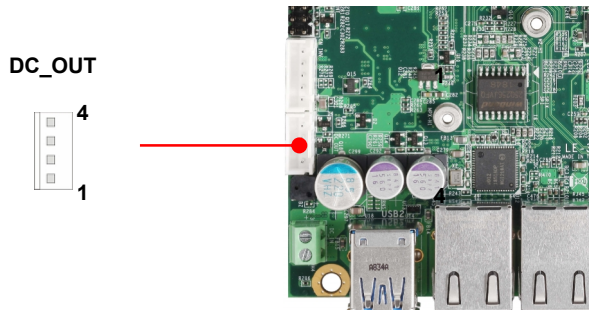

DC_OUT: SATA power 4-pin connector

Pin	Signal
1	12V
2	GND
3	GND
4	5V

Appendix A <Flash BIOS>

A.1 <Flash tool>

The board is based on Insyde BIOS and can be updated easily by the BIOS auto flash tool. You can download the tool online at the address below:

[FPT Tool](#)

The tool's file name is "FPT.exe", it's the utility that can write the data into the BIOS flash chip and update the BIOS.

A.2 <Flash BIOS process>

1. Press Del to Enter BIOS Menu
2. On Front Page screen, click Setup Utility
3. On Advanced screen, click PCH-IO Configuration, then click Security Configuration
4. Set BIOS Lock to [Disabled], then save changes.

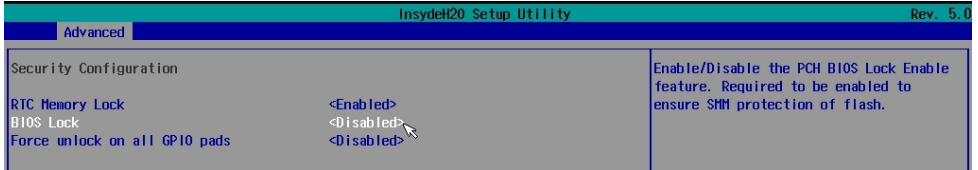

5. Please make a boot-able Disk which could boot into DOS environment.
6. Un-zip attached files and copies it into boot-able Disk.
7. Power on the system and flash the BIOS under the DOS environment.

The instruction will be "C:/fpt_-savemac_-f_XXXX.BIN"

Note: a. Underscore means Space

b. xxxx.bin means the BIOS file that you want to update

8. Please turn off the system and clean CMOS by Jumper.
9. Turn on the system and update BIOS successful.

Appendix B <LCD Panel Type select>

Accordinging your panel, it needs to select the correct resolution in the BIOS. If there is no fit your panel type, please feedback for us to make OEM model.

Find the setting from

Front Page-> Setup Utility

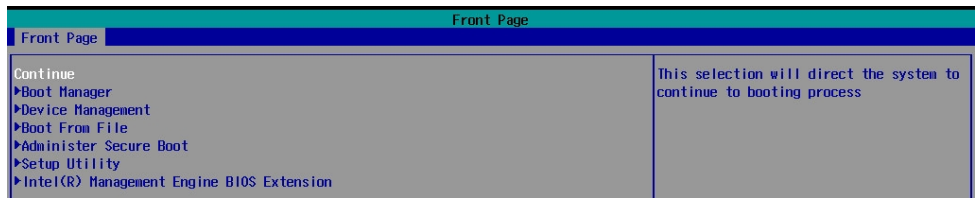

Advanced→ LVDS Configuration



Set 18bit /24bit, Single /Dual channel in LVDS configuration

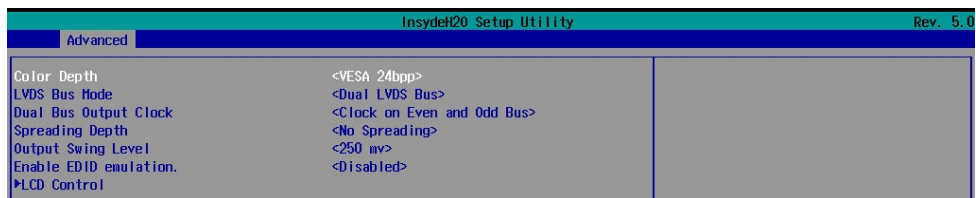

LVDS configuration → LCD Control

There are 16 resolutions in LCD Panel Type. (For Dual boot and Legacy boot)

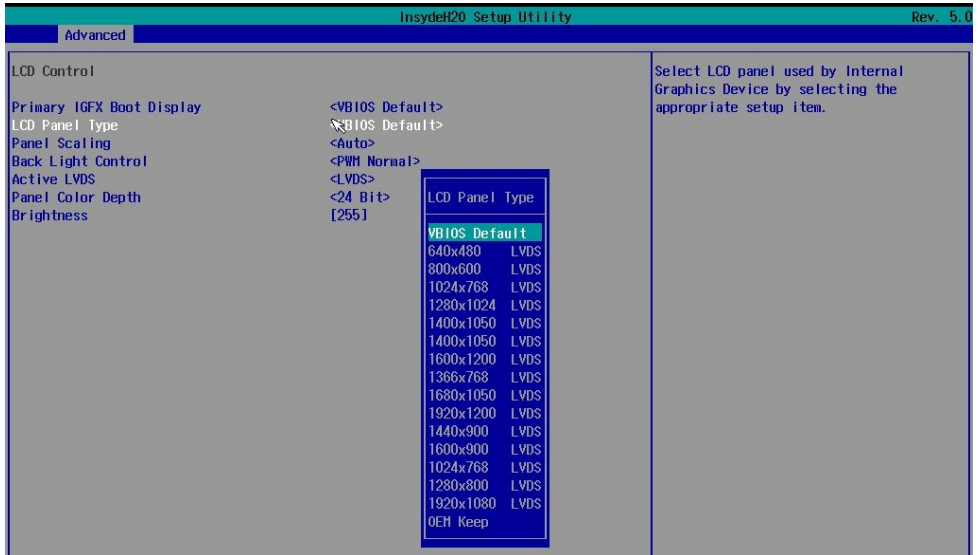
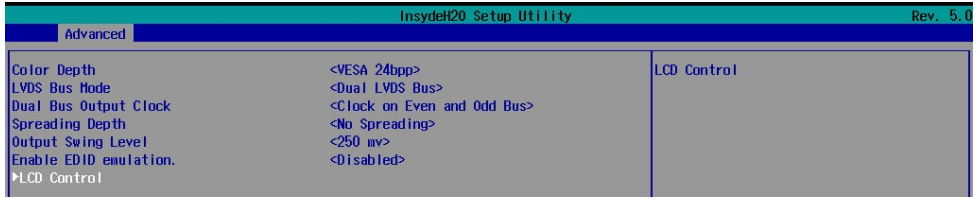

Appendix C <Programmable Watch Dog Timer>

The watchdog timer makes the system auto-reset while it stops to work for a period. The integrated watchdog timer can be setup as system reset mode by program. You can select Timer setting in the BIOS, after setting the time options, the system will reset according to the period of your selection.

Find the setting from

Advanced→Super IO Configuration

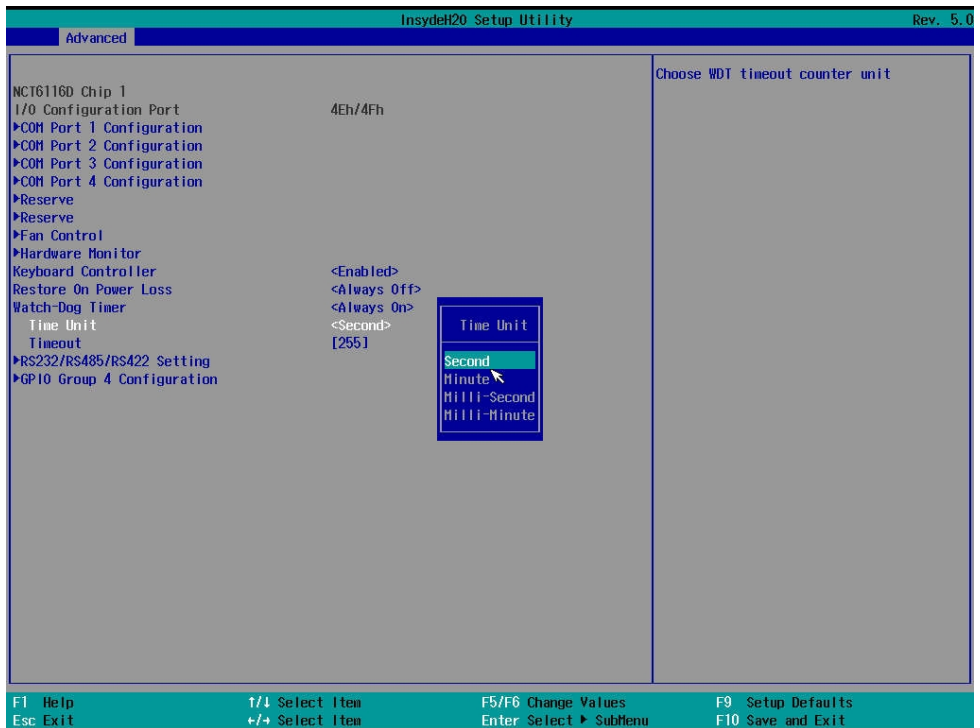

Timeout value range

1 to 255 Minute and Second

Program sample

Watchdog timer setup as system reset with 5 second of timeout

```
-o 4E 87      ;enter configuration
-o 4E 87
-o 4E 07
-o 4F 08      ;select Logical Device
-o 4E 30
-o 4F 01      ; activate WDTO# function
-o 4E F0
-o 4F 00      ;set "00" is second mode, set "08" is minute mode
-o 4E F1
-o 4F 05      ;00h: Timeout Disable
                ;01h: Timeout occurs after 1 minute only
                ;02h: Timeout occurs after 2 second/minute
                ;03h: Timeout occurs after 3 second/minute
                ;
                ;
                ;FFh: Timeout occurs after 255 second/minute
                (The deviation is approx 1 second.)
```

For further information, please refer to Nuvoton NCT6116D datasheet

Appendix D <Hardware Monitor>

Find the setting from

Advanced → Super IO Configuration → Hardware Monitor

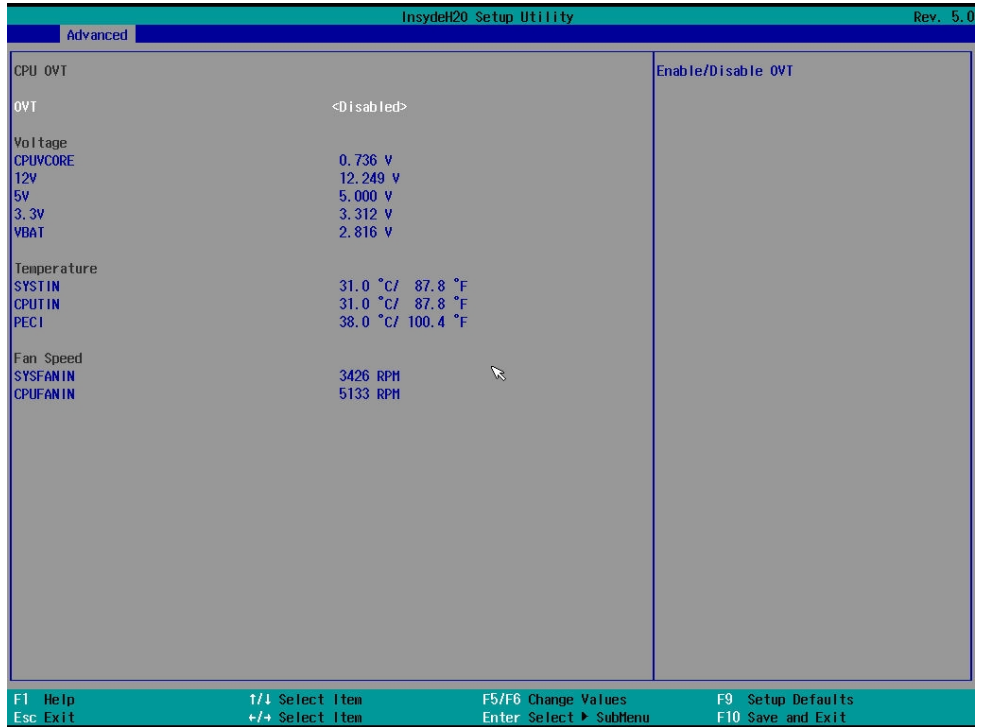

InsydeH20 Setup Utility		Rev. 5.0
Advanced		
CPU OVT		Enable/Disable OVT
OVT	<Disabled>	
Voltage		
CPUV CORE	0.736 V	
12V	12.249 V	
5V	5.000 V	
3.3V	3.312 V	
VBAT	2.816 V	
Temperature		
SYSTEM	31.0 °C/ 87.8 °F	
CPU	31.0 °C/ 87.8 °F	
PCH	38.0 °C/ 100.4 °F	
Fan Speed		
SYSFAN IN	3426 RPM	
CPUFAN IN	5133 RPM	

F1 Help ↑/↓ Select Item F5/F6 Change Values F9 Setup Defaults
 Esc Exit ←/→ Select Item Enter Select ▸ Submenu F10 Save and Exit

Appendix E <Programmable GPIO>

The GPIO can be programmed with the MS-DOS debug program using simple IN/OUT commands.

GPIO	0	1	2	3	4	5	6	7
bit	0	1	2	3	4	5	6	7

- o 4E 87 ;enter configuration
- o 4E 87
- o 4E 07
- o 4F 07 ;select Logical Device
- o 4E 30
- o 4F 10 ;activate GPIO function (The board use GPIO4)
- o 4E F0
- o 4F XX ;set "01" GPIO as input, set "00" GPIO as output
- o 4E F1
- o 4F XX ;if set GPIO as output, this register's value can be set "00~ FF"

Optional

- o 4E F2
- o 4F XX ;set "01", the respective bit are inverted (Both input and output)
- ;set "00", the respective bit are normal

For further information, please refer to Nuvoton NCT6116D datasheet

Appendix F <RAID Setting>

When use RAID function, it need to enter the BIOS set RAID mode first.

Advanced → PCH-IO Configuration → SATA and RST Configuration

→ SATA Mode Selection



At boot time, press <CTRL + I> to enter the RAID configuration menu.



Appendix G <Setup ADP-3355,ADP-3460>

LE-37NT Series have a VGA or 2nd LVDS, it's no need install extra driver.

For further information, please refer to the manual.

ADP-3355 manual [Link](#)

ADP-3460 manual [Link](#)

Contact information

Any advice or comment about our products and service, or anything we can help you please don't hesitate to contact with us. We will do our best to support you for your products, projects and business.

Taiwan Commate computer Inc.

Address	19F., NO.94, Sec. 1, Xintai 5 th Rd., Xizhi Dist., New Taipei City 22102, Taiwan.
TEL	+886-2-26963909
Website	www.commell.com.tw
E-mail	info@commell.com.tw (General information) tech@commell.com.tw (Technical Support)

Commell is a brand name of Taiwan Commate computer Inc.