

Lantech

LPES-3424

24 10/100TX PoE at/af + 4 DualSpeed SFP L2+ Switch

User Manual



Nov. 2014

Important Notice

Lantech Communications Global, Inc. reserves the right to modify the equipment, its specification or this manual without prior notice, in the interest of improving performance, reliability, or servicing. At the time of publication all data is correct for the operation of the equipment at the voltage and/or temperature referred to. Performance *data* indicates typical values related to the particular product.

No part of this documentation or information supplied may be divulged to any third party without the express written consent of Lantech Communications Global Inc. Products offered may contain software which is proprietary to Lantech Communications Global Inc. The offer or supply of these products and services does not include or infer any transfer of ownership.

Interference Issues

This Equipment has been tested and found to comply with the limits for a Class A digital device, pursuant to Part 15 of the FCC rules. These limits are designed to provide reasonable protection against harmful interference in a commercial or installation. This equipment generates, uses, and can radiate radio frequency energy. It may cause harmful interference to radio communications if the equipment is not installed and used in accordance with the instructions.

FCC Warning

This Equipment has been tested and found to comply with the limits for a Class-A digital device, pursuant to Part 15 of the FCC rules. These limits are designed to provide reasonable protection against harmful interference in a residential installation. This equipment generates, uses, and can radiate radio frequency energy. It may cause harmful interference to radio communications if the equipment is not installed and used in accordance with the instructions. However, there is no guarantee that interference will not occur in a particular installation. If this equipment does cause harmful interference to radio or television reception, which can be determined by turning the equipment off and on, the user is encouraged to try to correct the interference by one or more of the following measures:

- Reorient or relocate the receiving antenna.
- Increase the separation between the equipment and receiver.
- Connect the equipment into an outlet on a circuit different from that to which the receiver is connected.
- Consult the dealer or an experienced radio/TV technician for help.

CE Mark Warning

This is a Class-A product. In a domestic environment this product may cause radio interference in which case the user may be required to take adequate measures.

Content

Chapter 1 Introduction	1
Specification	1
Chapter 2 Hardware Description.....	6
2.1 Physical Dimension.....	6
2.2 LED Indicators	7
Chapter 3 Hardware Installation	8
Hardware installation	8
3.1 Rack Mounting.....	9
3.2 Wiring the Power Inputs	11
3.3 Cabling	12
Chapter 4 Console Management.....	15
1. Connecting to the Console Port	15
2. Login in the Console Interface	16
Chapter 6 Web-Based Management	18
1. About Web-based Management	18
2. Preparing for Web Management	18
3. System Login.....	19
4. System	20
6.4.1 System Identification Configuration.....	20
6.4.2 Switch Information	21
6.4.3 IP configuration.....	21
6.4.4 DHCP server.....	22
6.4.5 System Time	24
6.4.6 SNMP Configuration	27
5. Event & Log	30

6.5.1 View Logs	30
6.5.2 Events	31
6.5.3 DDM event.....	32
6.5.4 Actions	33
6.5.5 Event Action Map	36
6.6 Ports	38
6.6.1 Device Settings.....	38
6.6.2 Status	39
6.6.3 Statistics	39
6.6.4 Mirroring.....	40
6.6.5 Rate Limiting.....	41
6.6.6 Loop Protection.....	42
6.7 Power over Ethernet	43
6.7.1 Configuration	43
6.7.2 Status	44
6.7.3 Detection.....	46
6.7.4 Scheduling	47
6.8 Topology.....	48
6.9 QoS	51
6.9.1 QoS Policy	51
6.10 Security	53
6.10.1 MAC Address Tables.....	53
6.10.2 Access Control List.....	54
6.10.3 IEEE 802.1X Radius Server	55
6.10.4 IP Security	56
6.11 VLAN	57
6.11.1 802.1Q VLAN Config	57
6.11.2 Status.....	59

6.12 MVR	60
6.12 LLDP	61
6.12.1 LLDP Configuration	61
6.12.2 LLDP Neighbor	62
6.12.3 LLDP Statistics	64
6.13 CDP	67
6.13.1 CDP Configuration Device Settings	67
6.13.2 CDP Port Configuration	68
6.13.3. CDP Status	68
6.14 IGMP Snooping	70
6.14.1 IGMP Snooping Configuration.....	71
6.14.2 IGMP Snooping Status	72
6.15 MSTP	74
6.15.1. MSTP Global Configuration	74
6.15.2 How to enable MSTP.....	75
6.15.3 CIST Settings.....	77
6.15.3.1 Bridge configuration	77
6.15.3.2 Port.....	77
6.15.4. MSTP MSTI Settings.....	78
6.15.5. MSTP Bridges Status	79
6.15.6. Bridge status of all ports	80
6.16 Aggregation.....	81
6.16.1. Aggregation Configuration.....	81
6.16.2 LACP Port Status	82
6.20 Maintenance	83
6.20.1 Save Configuration	83
6.20.2 Config backup/restore	83

6.20.3 Restart device.....	85
6.20.4 Firmware Upgrade.....	85
6.20.5 Diagnostics	85
Appendix —Command Line mode	89

Chapter 1 Introduction

Lantech LPES-3424 is a high performance L2 + managed switch which provides L2 wire speed and advanced security function for network aggregation and backbone deployment. It delivers all ports Gigabit speed with QoS, advanced security, LLDP/Cisco Discovery Protocol for the scalability and resiliency. LPES-3424 can recognize the diagnostic SFP and display SFP parameters on WebUI.

Compliant with IEEE802.3at/af standard, the Lantech LPES-3424 is able to feed each PoE port up to 30Watts@54VDC providing the connected PD devices at Gigabit speed. It also supports advanced PoE management* including PoE detection and scheduling. PoE detection* can detect if the connected PD is still alive then sending power; PoE scheduling* is to allow pre-set power feeding schedule upon routine time table.

Specification

Hardware Specification	
IEEE Standards	IEEE 802.3 10Base-T Ethernet IEEE 802.3u 100Base-TX Ethernet IEEE 802.3ab 1000Base-TX Ethernet IEEE 802.3z Gigabit Fiber IEEE 802.3x Flow Control Capability ANSI/IEEE 802.3 Auto-negotiation IEEE 802.1Q VLAN IEEE 802.1p Class of Service IEEE 802.1X Access Control IEEE 802.1D Spanning Tree IEEE 802.1w Rapid Spanning Tree IEEE 802.1s Multiple Spanning Tree IEEE 802.3ad Link Aggregation Control Protocol (LACP) IEEE 802.1AB Link Layer Discovery Protocol (LLDP) IEEE 802.3at / af PoE IEEE 802.1x User Authentication (Radius)

Switch Architecture	Back-plane (Switching Fabric): 12.8Gbps
Transfer Rate	14,880pps for Ethernet port 148,800pps for Fast Ethernet port
MAC Address	16K MAC address table
PoE pin assignment	RJ-45 port # 1~# 24 support PoE at/af End-point, Alternative A mode. Per port provides up to 30W @port capability. Positive (VCC+): RJ-45 pin 1,2. Negative (VCC-): RJ-45 pin 3,6.
Connectors	24 10/100TX RJ-45 with auto MDI/MDI-X function 4 100M / 1000M Mini-GBIC : SFP sockets RS-232 console: RJ-45
DDM	Conform to SFF-8472 to show diagnostic SFP with temperature, current, voltage, input and output power
Protocol	CSMA/CD
LED	Per unit: Power 1 (Green) Link/Activity (Green), Full duplex/collision(Yellow)), MINI GBIC (Link/Activity)(Green)
Power Supply	360W w/fan
Power Consumption	Full load: 20W
PoE Power Budget	340W
Case Dimension	19" Metal case; 440mm(W)x280mm(D)x44mm(H)
Operating Humidity	5%~95% (Non-condensing)
Operating Temperature	Standard: 0°C ~45°C(32°F ~113°F)
Storage Temperature	-40°C to 70°C (-40°F ~158°F)
FAN	One
Factory reset	Factory reset button to restore back to factory default settings.

button & watch dog design	Watch dog design can reboot switch automatically when CPU is found dead
RTC	RTC(Real Time Clock) to keep track of time always
EMI	FCC Class A, CE
Warranty	2 years
Software Specification	
Management	SNMP v1 v2c, v3/ Web/Telnet/CLI Management
SNMP MIB	RFC 1215 Traps MIB, RFC 1213 MIBII RFC 1158 MIBII RFC 1157 SNMP MIB, RFC 1493 Bridge MIB, RFC 1573 IF MIB RFC 2674 VLAN MIB, Partial RFC 1643 EtherLike, RFC 1757 RMON, RFC 2674 Q-Bridge MIB RFC 2790 Host Resource MIB RSTP MIB* LLDP MIB* Private MIB
VLAN	Port based VLAN, up to 28 groups IEEE802.1Q Tag VLAN Static VLAN groups up to 256, Dynamic VLAN group up to 2048, VLAN ID from 1 to 4096.
Port Trunk with LACP	LACP Port Trunk: 127 Trunk groups/Maximum 4 trunk members
LLDP	Support LLDP to allow switch to advise its identification and capability on the LAN
CDP	Cisco Discovery protocol for topology mapping
Spanning Tree	Support IEEE802.1d Spanning Tree,IEEE802.1w Rapid Spanning Tree, IEEE 802.1s MSTP
Quality of	The quality of service determined by port, Tag and IPv4 Type of

Service	service, IPv4 Differentiated Services Code Points - DSCP
Class of Service	Support IEEE802.1p class of service, per port provides 8 priority queues
Port Mirror	Support 3 mirroring types: "RX, TX and Both packet"
Multicast Filtering & IGMP	<p><i>Dynamic:</i></p> <p>Support IGMP snooping v1, v2,v3</p> <p>Support 256 multicast groups</p> <p>Support IGMP query</p> <p>Support Dynamic IGMP router port for reversed multicast video flow</p>
Bandwidth Control	<p>Support ingress packet filter and egress packet limit.</p> <p>The egress rate control supports all of packet type, the limit rates are 0~100Mbps.</p> <p>Ingress filter packet type combination rules are Broadcast/Multicast/Flooded Unicast packet, Broadcast/Multicast packet, Broadcast packet only and all types of packet. The packet filter rate can be set from 0 to 100Mbps</p> <p>The packet filter rate can be set an accurate value through the pull-down menu for the ingress packet filter and the egress packet limit.</p>
Network Security	<p>Support 10 IP addresses that have permission to access the switch management and to prevent unauthorized intruder.</p> <p>802.1X access control for port based and MAC based authentication</p> <p>Account access control management</p> <p>256 Policy based Access Control List</p> <p>SSL/ SSH for Management</p>
PoE Management	<ul style="list-style-type: none"> ■ PoE Detection to check if PD is hang up then restart the PD ■ PoE Scheduling to On/OFF PD upon routine time table ■ Per port PoE status : voltage, current, watt and temperature
Flow Control	Support Flow Control for Full-duplex and Back Pressure for Half-duplex
System Log	Support System log record and remote system log server
SMTP, SMS	Support SMTP Server and 6 e-mail accounts for receiving event

	alert; Can send alert via mobile SMS text
SNMP Trap	Up to 3 Trap stations Cold start, Port link up, Port link down, Authentication Failure, Private Trap for power status, PoE port event
DHCP	Provide DHCP Client/ DHCP Server
DNS	Provide DNS client feature and support Primary and Secondary DNS server.
SNTP	Support SNTP to synchronize system clock in Internet
Firmware Update	Support TFTP /HTTPS firmware update with auto provision
Configuration backup and restore	Support TFTP/FTP backup and restore; InstaConfig** mass configuration

Chapter 2 Hardware Description

In this paragraph, it will describe the switch's hardware spec, port, cabling information, and wiring installation.

2.1 Physical Dimension

Metal case. IP-30,
440(W) x 280 (D) x 44 (H) mm

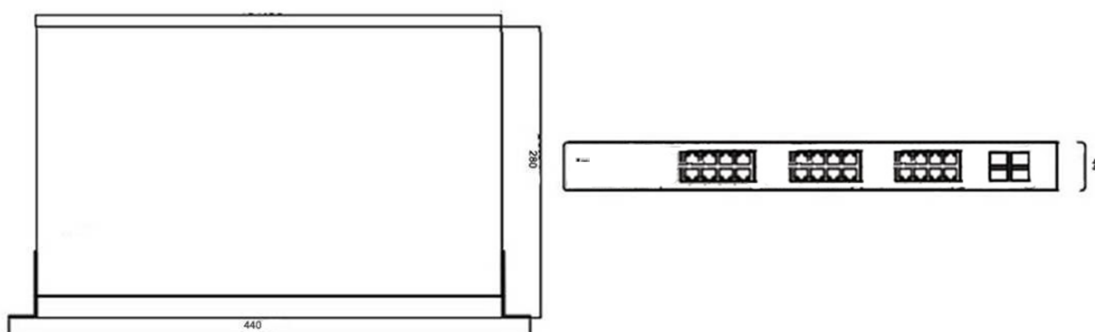

2.2 LED Indicators

The diagnostic LEDs that provide real-time information of system and optional status are located on the front panel of the switch. The following table provides the description of the LED status and their meanings for the switch.

LED	Color	Status	Meaning
R.M	Green	On	The switch unit is owner switch of ITU-Ring
		Off	The switch is not owner switch
PWR1	Green	On	Power 1 is active
		Off	Power 1 is inactive
PWR2	Green	On	Power 2 is active
		Off	Power 2 is inactive
FAULT	Red	On	Power or port failure
		Off	No failure
RJ-45	Link/Ack	On	A network device is detected.
		Blinking	The port is transmitting or receiving packets from the TX device.
		Off	No device attached
	Speed 1000M	On	The port is operating in 1000T mode.
	PoE	Off	The port is not operating in PoE mode.
		On	The port is operating in PoE mode.
SFP	Link/Ack	On	A network device is detected.
		Blinking	The port is transmitting or receiving packets from the TX device.
		Off	No device attached.
	Speed 1000M	On	The port is operating in 1000T mode.

Chapter 3 Hardware Installation

Hardware installation

1. Unpack the switch
2. Check if the Rack mount brackets are screwed on the switch or not. If the Rack mount brackets are not screwed on the switch, please refer to **Rack Mounting** section for rack installation.
3. To install the switch in a 19 inch Rack.
4. Power on the switch. Please refer to the **Wiring the Power Inputs** section for knowing the information about how to wire the power. The power LED on the switch will light up.
5. Prepare the twisted-pair, straight through Category 5 cable for Ethernet connection.
6. Insert one side of RJ-45 cable (category 5) into the switch Ethernet port (RJ-45 port) and another side of RJ-45 cable (category 5) to the network device's Ethernet port (RJ-45 port), ex: Switch PC or Server. The UTP port (RJ-45) LED on the switch will light up when the cable is connected with the network device. Please refer to the **LED Indicators** section for LED light indication.
7. When all connections are set and LED lights all show in normal, the installation is complete.

3.1 Rack Mounting

When installing the IPGS/IGS-5424 switch in a 19 inch rack, it must always be mounted horizontally with the top side up, This procedure requires the following items:

- Eight bracket screws (included with the switch)
- Two equipment rack brackets (included with the switch)
- Cross-head screwdriver (not provided)
- Four standard equipment rack screws (not provided)

Perform this procedure to install the switch in a 19-inch equipment rack:

1. Secure the two rack mount brackets to the sides of the switch using the eight bracket screws provided.

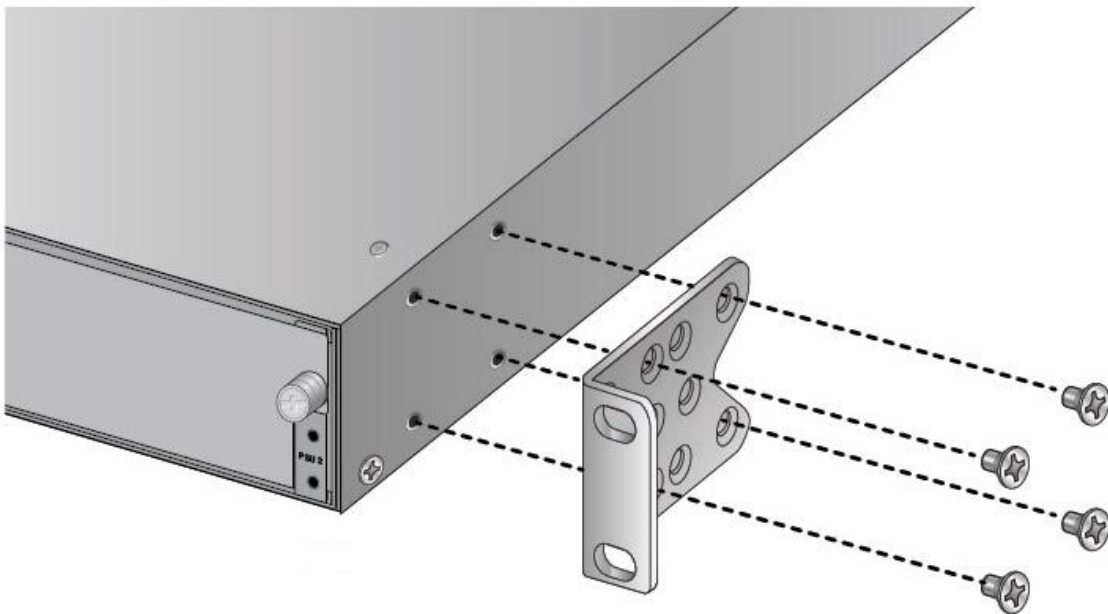

2. Have another person hold the switch in the equipment rack while you secure it using standard rack mount screws (not provided).

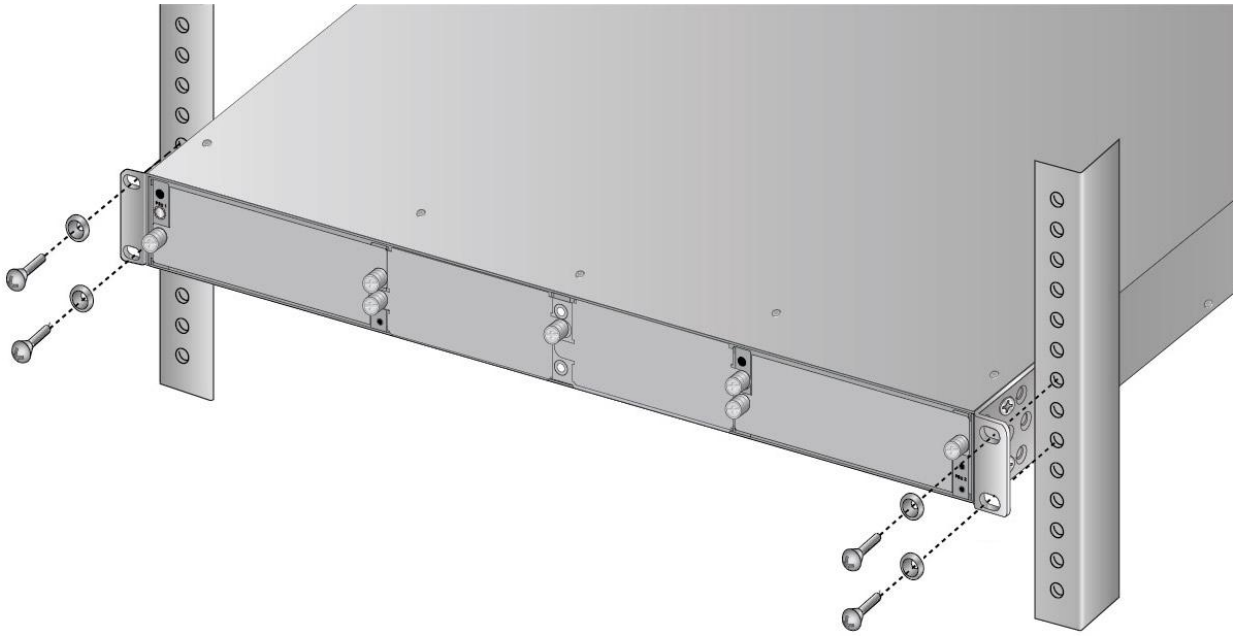

3.2 Wiring the Power Inputs



Please follow the steps below to insert the power wire.

1. connect the power cords to the connectors on the back module and to the appropriate power sources.



3.3 Cabling

- Use four twisted-pair, Category 5e or above cabling for RJ-45 port connection. The cable between the switch and the link partner (switch, hub, workstation, etc.) must be less than 100 meters (328 ft.) long.
- Fiber segment using **single-mode** connector type must use 9/125 μm single-mode fiber cable. User can connect two devices in the distance up to **30km**.
- Fiber segment using **multi-mode** connector type must use 50 or 62.5/125 μm multi-mode fiber cable. User can connect two devices up to **2km** distances.
- **Gigabit SFP (mini-GBIC) port:**

The small form-factor pluggable (SFP) is a compact optical transceiver used in optical communications for both telecommunication and data communications. The SFP slots supporting Gigabit speed up to 1000Mbps. They are used for connecting to the network segment with single or multi-mode fiber. You can choose the appropriate SFP transceiver to plug into the slots. Then use proper multi-mode or single-mode fiber according to the transceiver. With fiber optic, it transmits at speed up to 1000 Mbps and you can prevent noise interference from the system.

To connect the transceiver and LC cable, please follow the steps shown below:

First, insert the transceiver into the SFP module. Notice that the triangle mark is the bottom of the module.

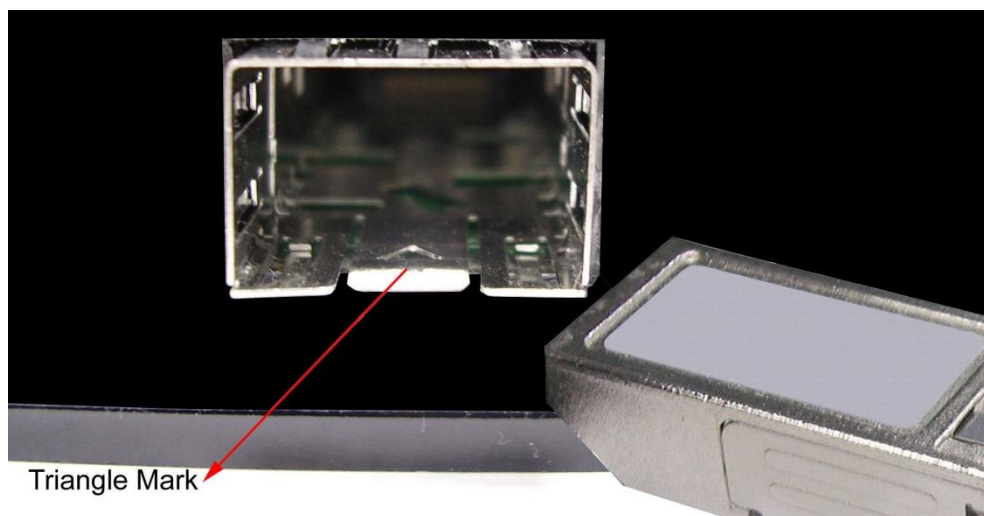

Transceiver to the SFP module

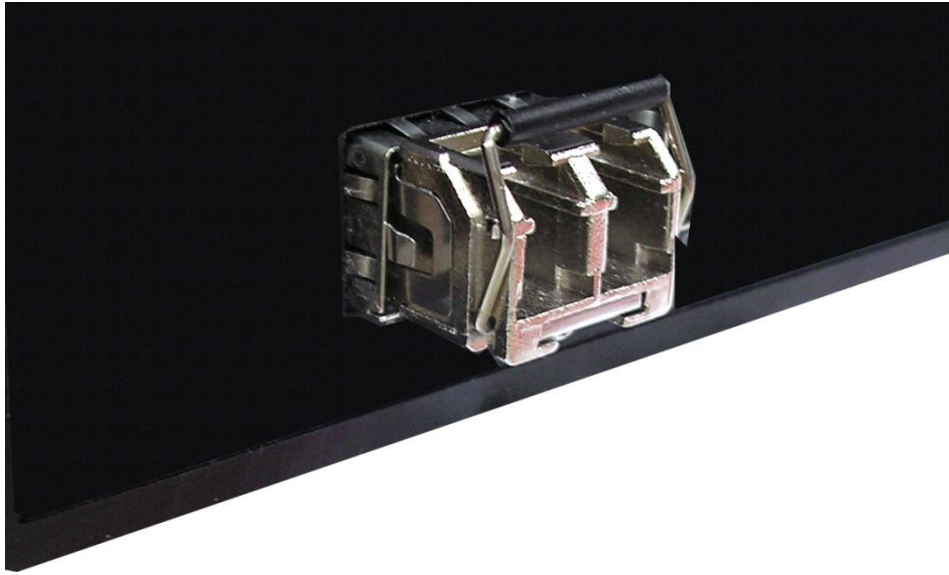

Transceiver Inserted

Second, insert the fiber cable of LC connector into the transceiver.

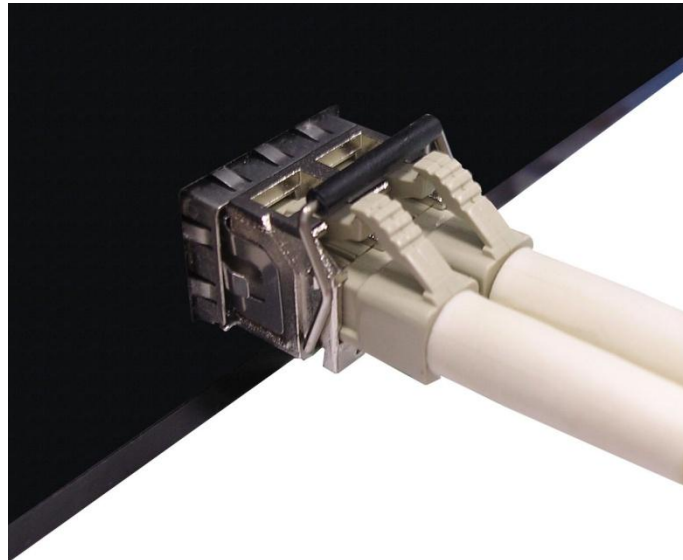

LC connector to the transceiver

To remove the LC connector from the transceiver, please follow the steps shown below:

First, press the upper side of the LC connector to release from the transceiver and pull it out.

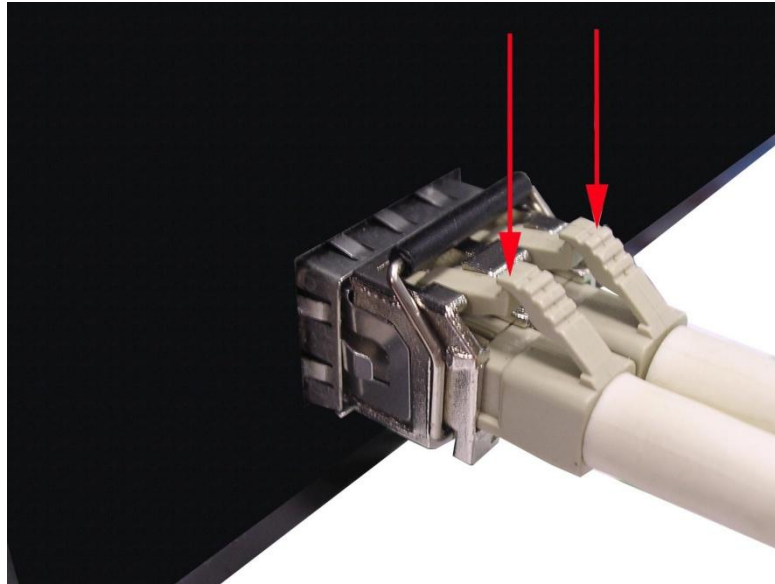

Remove LC connector

Second, push down the metal loop and pull the transceiver out by the plastic handle.

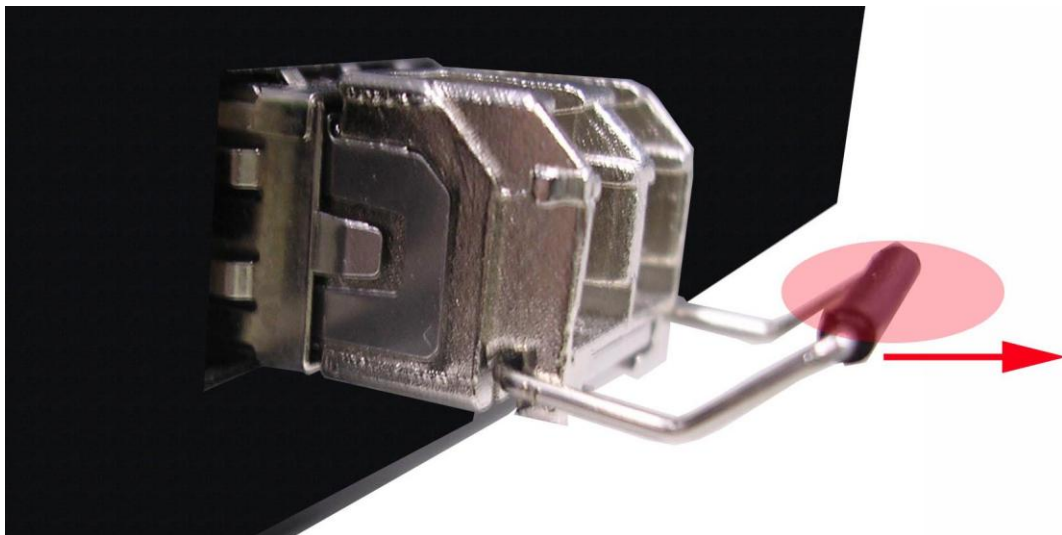

Pull out from the transceiver

Chapter 4 Console Management

1. Connecting to the Console Port

The supplied RS-232 cable which one end is DB9 female connector and the other end is DB9 male connector. Attach the end of DB9 female connector to PC or terminal and the other end of DB9 male connector to the console port of the switch. The connected terminal or PC must support the terminal emulation program.

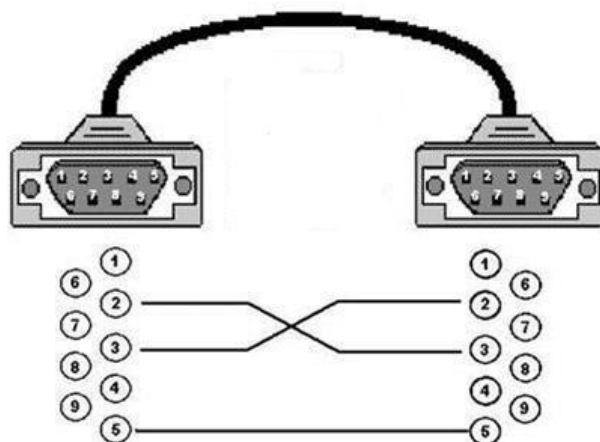

2. Login in the Console Interface

When the connection between Switch and PC is ready, turn on the PC and run a terminal emulation program or **Hyper Terminal** and configure its **communication parameters** to match the following default characteristics of the console port:

Baud Rate: 115200 bps

Data Bits: 8

Parity: none

Stop Bit: 1

Flow control: None

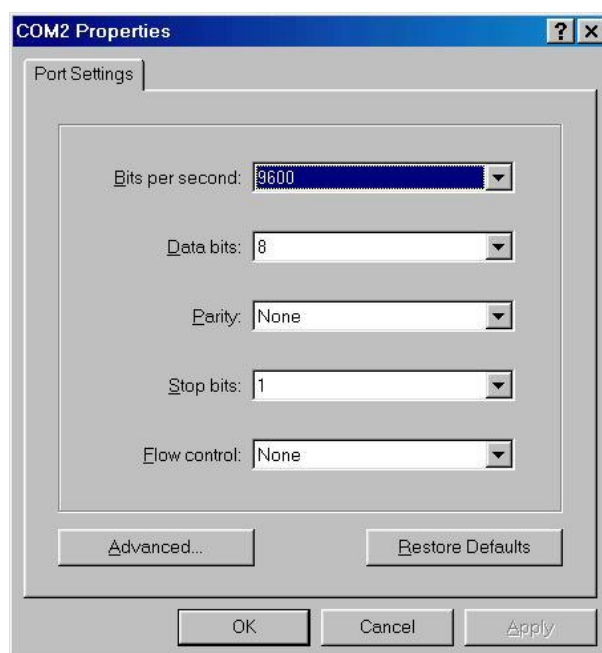

The settings of communication parameters

Having finished the parameter settings, click '**OK**'. When the blank screen shows up, press Enter key to have the login prompt appears. Key in '**admin**' (default value) for both User name and Password (use **Enter** key to switch), then press Enter and the Main Menu of console management appears. Please see below figure for login screen.

```
User Name : admin
```

```
Password : ****
```

Console login interface

Chapter 6 Web-Based Management

This section introduces the configuration and functions of the Web-Based management.

1. About Web-based Management

There is an embedded HTML web site residing in flash memory on CPU board of the switch, which offers advanced management features and allows users to manage the switch from anywhere on the network through a standard browser such as Microsoft Internet Explorer.

The Web-Based Management supports Internet Explorer 6.0 or later version. And, it is applied for Java Applets for reducing network bandwidth consumption, enhance access speed and present an easy viewing screen.

2. Preparing for Web Management

Before using the web management, install the switch on the network and make sure that any one of the PCs on the network can connect with the switch through the web browser. The switch default value of IP, subnet mask, username and password are listed as below:

- IP Address: **192.168.16.1**
- Subnet Mask: **255.255.255.0**
- Default Gateway: **192.168.16.254**
- User Name: **admin**
- Password: **admin**

3. System Login

1. Launch the Internet Explorer on the PC(the switch also support Mozila and Chrome browser).
2. Key in “http:// +” the IP address of the switch”, and then Press “**Enter**”.



3. The login screen will appear right after
4. Key in the user name and password. The default user name and password are the same as ‘**admin**’.
5. Press **Enter** or click the **OK** button, and then the home screen of the Web-based management appears.
6. The switch also support SSL security login, if you need SSL to protect your access account of switch, please key in “https//” + “ the IP address of switch “, and press “Enter”

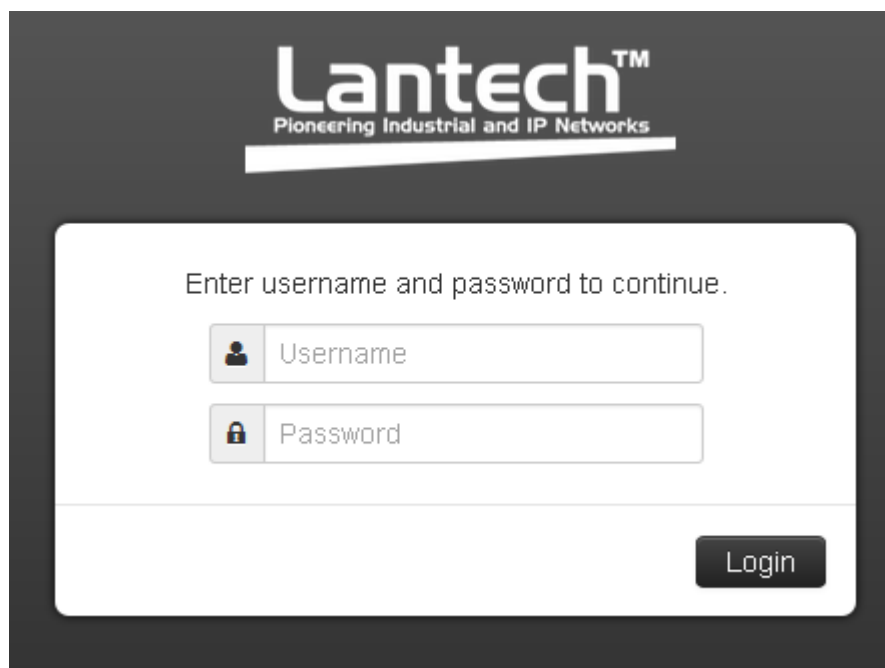
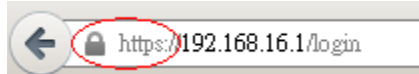

Login screen

4. System

6.4.1 System Identification Configuration

Name:

An administratively assigned name for this managed switch. By convention, this is the node's fully-qualified domain name. A domain name is a text string drawn from the alphabet (A-Z), digits (0-9), minus sign (-). No space characters are permitted as part of a name. The first or last character must not be a minus sign. The allowed string length is 0 to 255.

Description:

Display the description of switch. The allowed string length is 0 to 255.

Location:

The physical location of this node(e.g., telephone closet, 3rd floor). The allowed string length is 0 to 255, and the allowed content is the ASCII characters from 32 to 126.

Contact:

The textual identification of the contact person for this managed node, together with information on how to contact this person. The allowed string length is 0 to 255, and the allowed content is the ASCII characters from 32 to 126.

System Identification Configuration

Name:

Description:

Location:

Contact:

6.4.2 Switch Information

User can find the system name, description, location and contact personnel to identify the switch. The version table below is a read-only field to show the basic information of the switch.

System Information

Identification	
Name	The Switch
Description	Current used
Location	Taiwan Taipei
Contact	Engineer

Information	
Device Time	2013年11月5日 下午 04:38:22
Up Time	2263
Software Version	V3.34
Kernel Version	57292a0b
MAC Address	28:60:46:a0:04:f5
Hardware Model	IES-5408DFT
Hardware Description	2 10/100/1000T +2 100/1000 SFP + 8 10/100TX L2+ Industrial Managed Switch

6.4.3 IP configuration

The switch is a network device which needs to be assigned an IP address for being identified on the network. Users can select a method of assigning IP address to the switch.

- **DHCP Client:** Enable or disable the DHCP client function. When DHCP client function is enabled, the switch will obtain an IP address from the network DHCP server automatically. The default IP address will be replaced by the assigned IP address from the DHCP server. After the user clicks **Apply**, a popup dialog shows up to inform the user that when the DHCP client is enabled, the current IP will lose and user should find the new IP obtained from the DHCP server.
- **IP Address:** Assign a static IP address to the switch from the subnet address

range that the network is using. If DHCP client function is enabled, this switch is configured as a DHCP client. The network DHCP server will assign the IP address to the switch and the switch displays it in this column. The default IP is 192.168.1.88 or the user can choose an IP address manually when DHCP Client is disabled.

- **Subnet Mask:** Assign the subnet mask of the IP address. If DHCP client function is disabled, the user has to assign the subnet mask in this column field.
- **Gateway:** Assign the network gateway for the switch. If DHCP client function is disabled, the user has to assign the gateway in this column field. The default gateway is 192.168.1.254.
- **DNS Server IP:** Assign the primary DNS IP address.
- And then, click .

DHCP client:

IP Address:

IPv6 Address:

Network Mask:

Default Gateway:

DNS Server IP:

6.4.4 DHCP server

DHCP is the abbreviation of Dynamic Host Configuration Protocol that is a protocol for assigning dynamic IP addresses to devices on a network. With dynamic addressing, a device can have a different IP address every time it connects to the network. In some systems, the device's IP address can even change while it is still

connected. DHCP also supports a mix of static and dynamic IP addresses. Dynamic addressing simplifies network administration because the software keeps track of IP addresses rather than requiring an administrator to manage the task. This means that a new computer can be added to a network without the hassle of manually assigning it a unique IP address.

The system provides the DHCP server function. Having enabled the DHCP server function, the switch system will be configured as a DHCP server.

- **DHCP Server:** Enable or Disable the DHCP Server function. Enable—the switch will be the DHCP server on your local network.
- **IP Range(up):** Type in an IP address. Low IP address is the beginning of the dynamic IP range. For example, dynamic IP is in the range between 192.168.1.100 ~ 192.168.1.200. In contrast, 192.168.1.100 is the Low IP address.
- **IP Range(down):** Type in an IP address. High IP address is the end of the dynamic IP range. For example, dynamic IP is in the range between 192.168.1.100 ~ 192.168.1.200. In contrast, 192.168.1.200 is the High IP address.
- **Subnet Mask:** Type in the subnet mask of the IP configuration.
- **Gateway:** Type in the IP address of the gateway in your network.
- **DNS:** Type in the Domain Name Server IP Address in your network.
- **Lease Time:** It is the time period that system will reset the dynamic IP assignment to ensure the dynamic IP will not be occupied for a long time or the server doesn't know that the dynamic IP is idle.
- And then, click .

Enable DHCP Server

IP Range

Subnet Mask

Gateway

DNS

Lease Time

6.4.5 System Time

SNTP (Simple Network Time Protocol) is a simplified version of NTP which is an Internet protocol used to synchronize the clocks of computers to a specified time reference. Because time usually just advances, the time on different node stations will be different. With the communicating programs running on those devices, it would cause time to jump forward and back, a non-desirable effect. Therefore, the switch provides comprehensive mechanisms to access national time and frequency dissemination services, organize the time-synchronization subnet and the local clock in each participating subnet peer.

Daylight saving time (DST) is the convention of advancing clocks so that afternoons have more daylight and mornings have less. Typically clocks are adjusted forward one hour near the start of spring and are adjusted backward in autumn.

- **Time zone:** Universal Time Coordinated. Set the switch location time zone. The following table lists the different location time zone for your reference.

Local Time Zone	Conversion from UTC	Time at 12:00 UTC
-----------------	---------------------	-------------------

November Time Zone	- 1 hour	11am
Oscar Time Zone	-2 hours	10 am
ADT - Atlantic Daylight	-3 hours	9 am
AST - Atlantic Standard EDT - Eastern Daylight	-4 hours	8 am
EST - Eastern Standard CDT - Central Daylight	-5 hours	7 am
CST - Central Standard MDT - Mountain Daylight	-6 hours	6 am
MST - Mountain Standard PDT - Pacific Daylight	-7 hours	5 am
PST - Pacific Standard ADT - Alaskan Daylight	-8 hours	4 am
ALA - Alaskan Standard	-9 hours	3 am
HAW - Hawaiian Standard	-10 hours	2 am
Nome, Alaska	-11 hours	1 am
CET - Central European FWT - French Winter MET - Middle European MEWT - Middle European Winter SWT - Swedish Winter	+1 hour	1 pm
EET - Eastern European, USSR Zone 1	+2 hours	2 pm
BT - Baghdad, USSR Zone 2	+3 hours	3 pm

ZP4 - USSR Zone 3	+4 hours	4 pm
ZP5 - USSR Zone 4	+5 hours	5 pm
ZP6 - USSR Zone 5	+6 hours	6 pm
WAST - West Australian Standard	+7 hours	7 pm
CCT - China Coast, USSR Zone 7	+8 hours	8 pm
JST - Japan Standard, USSR Zone 8	+9 hours	9 pm
EAST - East Australian Standard GST Guam Standard, USSR Zone 9	+10 hours	10 pm
IDLE - International Date Line NZST - New Zealand Standard NZT - New Zealand	+12 hours	Midnight

■ **SNTP Client setting**

▪ **Time zone**

This field is to select the Timezone which this switch is located

▪ **Manual**

Synchronize the time with the desktop which connect with switch.

▪ **SNTP :**

This is to enable/disable the SNTP service, enable the SNTP client is to use the service from SNTP server, the system time will follow the SNTP server, disable is to use local time without any SNTP server information, note that the network should be enabled to have system receive time information from SNTP server if

it is enabled

- **NTP Sever :**

Set the SNTP server IP address. You can assign a local network time server's IP address or an internet time server's IP address.

- Click to have the configuration take effect.

Time Zone:

Clock Source:

Device Time: 2015年9月31日 下午 11:59:29

NTP Server:

6.4.6 SNMP Configuration

Simple Network Management Protocol (SNMP) is the protocol developed to manage nodes (servers, workstations, routers, switches and hubs etc.) on an IP network. SNMP enables network administrators to manage network performance, find and solve network problems, and plan for network growth. Network management systems learn of problems by receiving traps or change notices from network devices implementing SNMP.

- **Agent Version:** Select the SNMP version (V1/V2c or V3) that you want to use. And then Click. to switch to the selected SNMP version mode.

Here you can define the new community string set and remove the unwanted community string.

- **Community String:** Fill the name string.
- **Privilege:**Read only. Enables requests accompanied by this community string to display MIB-object information.

Read/write. Enables requests accompanied by this community string to display MIB-object information and to set MIB objects.

- Click. 

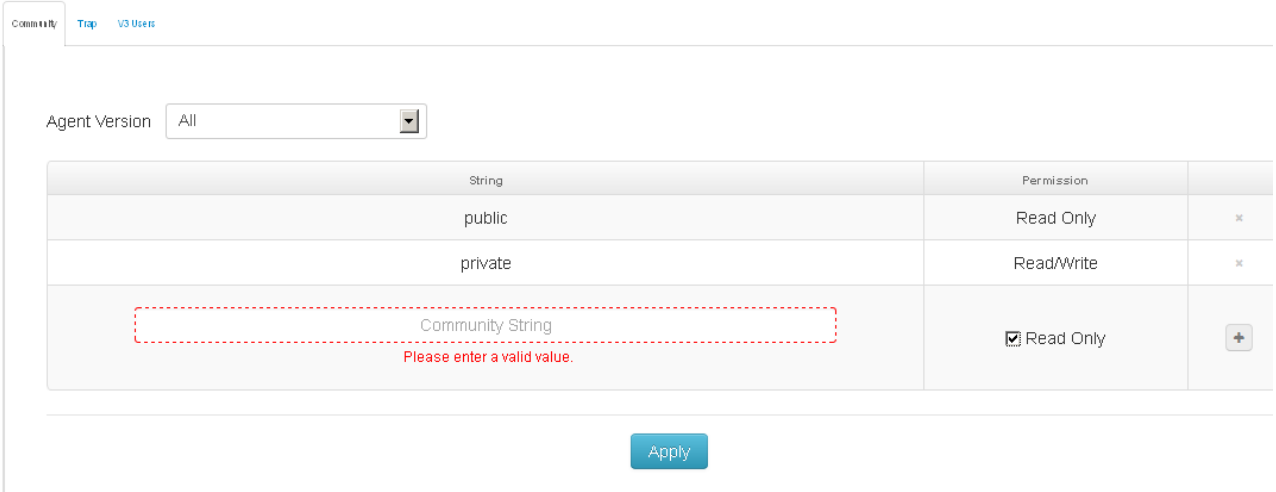

String	Permission	
public	Read Only	×
private	Read/Write	×
<input type="text" value="Community String"/>	<input checked="" type="checkbox"/> Read Only	+

Please enter a valid value.

Apply

A trap manager is a management station that receives the SNMP trap messages generated by the switch. If no trap manager is defined, no traps will be issued. To define a management station as a trap manager, assign an IP address, enter the SNMP community strings, and select the SNMP trap version.

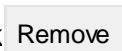
- **IP Address:** Enter the IP address of the trap manager.
- **Community:** Enter the community string for the trap station.
- **Version:** Select the SNMP trap version type—v1 or v2c.
- Click .
- To remove the community string, select the community string listed in the current manager's field and click .

Community | **Top** | V3 Users

IP Address	Community	Version
<input type="text" value="IP address"/>	<input type="text" value="public"/>	<input type="text" value="v2c"/> <ul style="list-style-type: none"> v1 <li style="background-color: #003366; color: white;">v2c

System Utilization

You can see the using rate of switch CPU and memory.

System Utilization

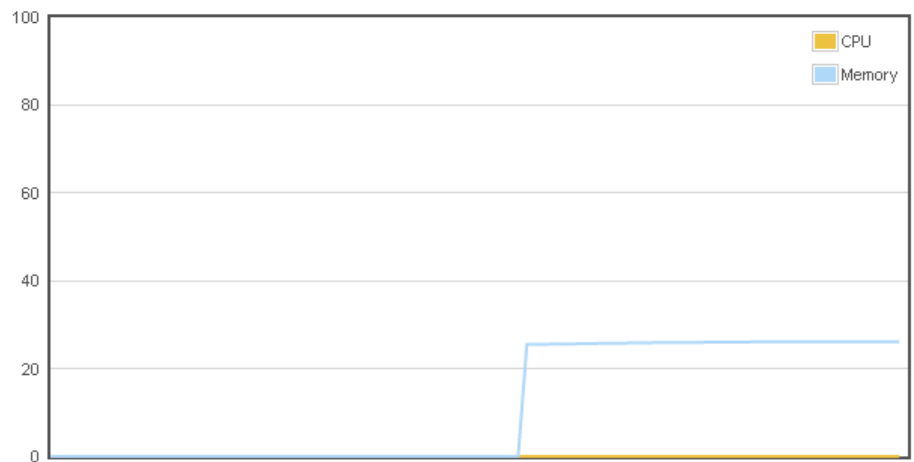







5. Event & Log

Logs

Login Boot DDM DIN Link Change Power

Clear

 22nd, 9:56:02 am	Link Change	Phyport(7).linkChg: down
 22nd, 9:47:33 am	Link Change	Phyport(7).linkChg: up
 22nd, 9:47:33 am	Link Change	Phyport(2).linkChg: up
 22nd, 9:47:31 am	Boot	System Bootup
 22nd, 9:47:08 am	Link Change	Phyport(2).linkChg: up
 22nd, 9:46:59 am	Link Change	Phyport(2).linkChg: down
 22nd, 9:46:43 am	Link Change	Phyport(2).linkChg: up
 22nd, 9:46:41 am	Boot	System Bootup
 22nd, 9:45:21 am	Link Change	Phyport(2).linkChg: up

6.5.1 View Logs

- This will show you the log in local interface, you can press  or F5 to refresh the web page and get the newest event log.

6.5.2 Events

Env Monitor Event DDM Edit

Environment Monitoring Event

Enable EnvMon Events:

Voltage

0.00 V 20.00 V 50.00 V 100.0

Range: 30.00 V

Current

0.033 A 1.500 A

Range: 1.467 A

Power

1.0 W 29.8 W 50.0

Range: 28.8 W

Temperature

-50.0 °C -20.0 °C 69.0 °C 100.0 °C

Range: 89.0 °C

[Apply](#)

6.5.2.1 Environmental Monitoring Event

You can set the trigger range of each event here, for example, if you set the blue bar in the range from 20V to 50V, when the voltage of power input is over 50VDC or lower than the 20VDC, it will trigger the event system.

6.5.3 DDM event

SFP Digital Diagnostic Monitor Event

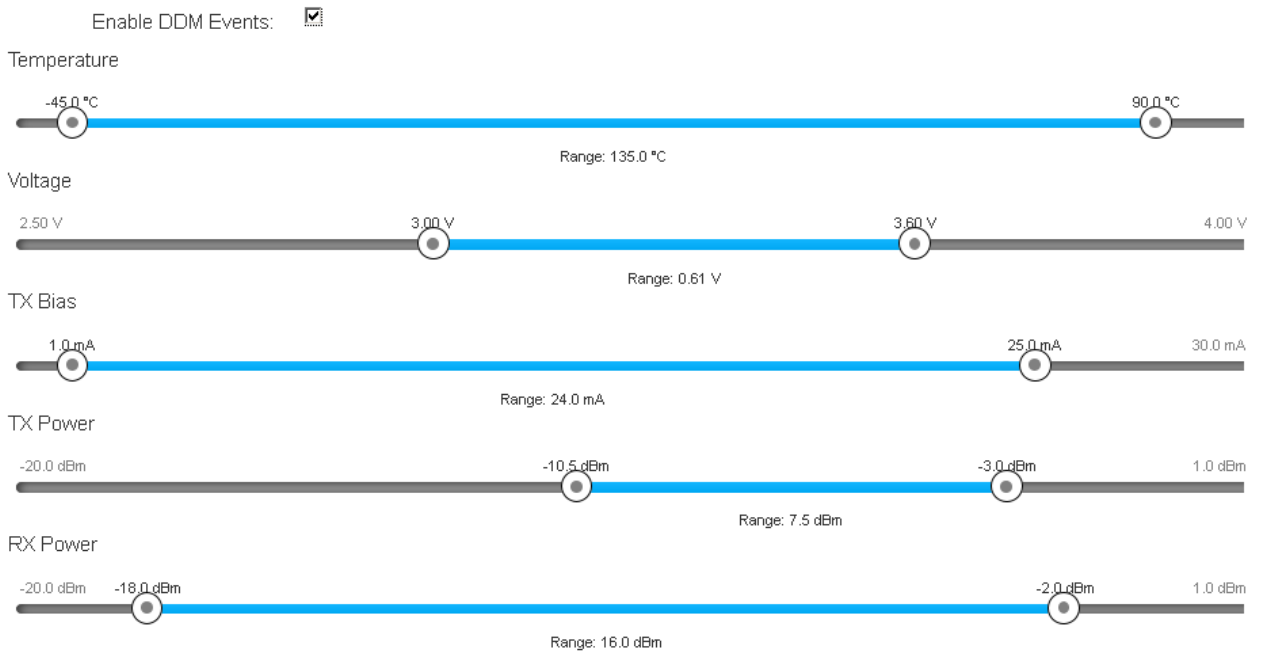

The switch supports DMI where can read all the parameters info from DDM SFP when plugged into SFP slots, the shown information is as above including SFP temperature, input voltage, TX bias, TX dBm and RX dBm.

You can set the trigger range of each event here, for example, when you set the blue bar in the range from -45°C to 90°C, if the working Temp. of SFP module is over 90°C or lower than the -45°C, it will trigger the event system.

Note: This function will be displayed when DDM SFP is inserted.

6.5.4 Actions

Actions

Local Log Action Remote SysLog Action Email Action SMS Action SNMP Trap Action DOut Action

Save to Local

Apply

6.5.4.1 Local Log Action

Save to Local: Save log to local file

Local Log Action Remote S

Save to Local

6.5.4.2 Remote Syslog Action

Log to Remote Syslog Server: Save log to Syslog Server

Local Log Action Remote SysLog Action Email Action

Log to Remote Syslog Server

Syslog Server: 0.0.0.0

Tag: node-event

Facility: user

Host Name: host

6.5.4.3 Email Action

Email Alert: Sent log via Email

Local Log Action Remote SysLog Action Email Action SMS Action SNMP Trap Action

Email Alert

Subject: Event Log

Cloud SMTP:

Receivers:

Please enter at least one receiver

6.5.4.4 SMS Action

SMS Alert: Sent log via SMS service.

(The must connect with internet and define the SMS server before using this function)

(Currently the SMS service is offered by Lantech in Taiwan.)

Local Log Action Remote SysLog Action Email Action SMS Action SNMP Trap Action



SMS Alert

The SMS alert service may charge usage fee in the future.

User ID: test

Password:

Sender Text: SYSOP

Phone Numbers:  phone number 

6.5.4.5 SNMP Trap Action

SNMP Trap Action: The setting page of this function will be redirect to SNMP TRAP.

Local Log Action Remote SysLog Action Email Action SMS Action SNMP Trap Action DOut Action

Please refer to [SNMP Trap](#)

6.5.3.6 DOut Action

DOUT Action: The setting page of this function will be redirect to Digital Input/Output.

Local Log Action Remote SysLog Action Email Action SMS Action SNMP Trap Action DOut Action

Please refer to the **Digital OUT** section of [Digital Input/Output](#)

6.5.5 Event Action Map

Event Action Map

Event Actions:

Event Actions for Link Change:

6.5.5.1 Event Actions:

A. Choose the event which you want to active

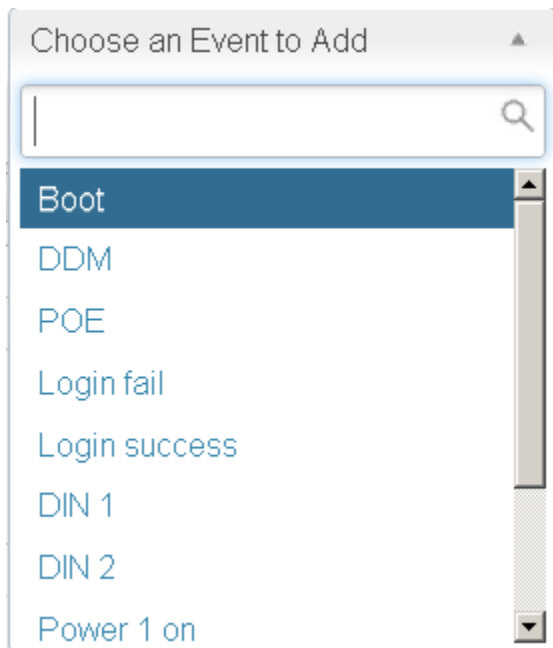

The image shows a dropdown menu with the title "Choose an Event to Add". The menu is open, displaying a search bar at the top and a list of events below. The "Boot" event is currently selected and highlighted in a dark blue bar. Other visible events in the list include "DDM", "POE", "Login fail", "Login success", "DIN 1", "DIN 2", and "Power 1 on".

B. You will find the event which you select will be display as below, then choose forwarding method to define how to forward this event to manager side.

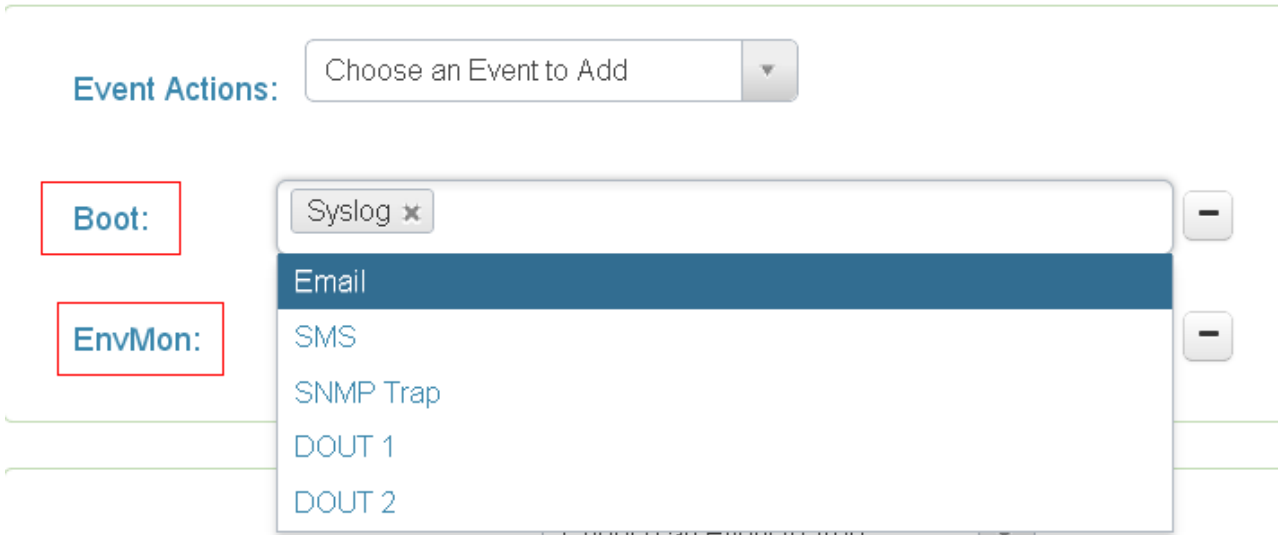

C. You can set the forwarding method of port break event in here.

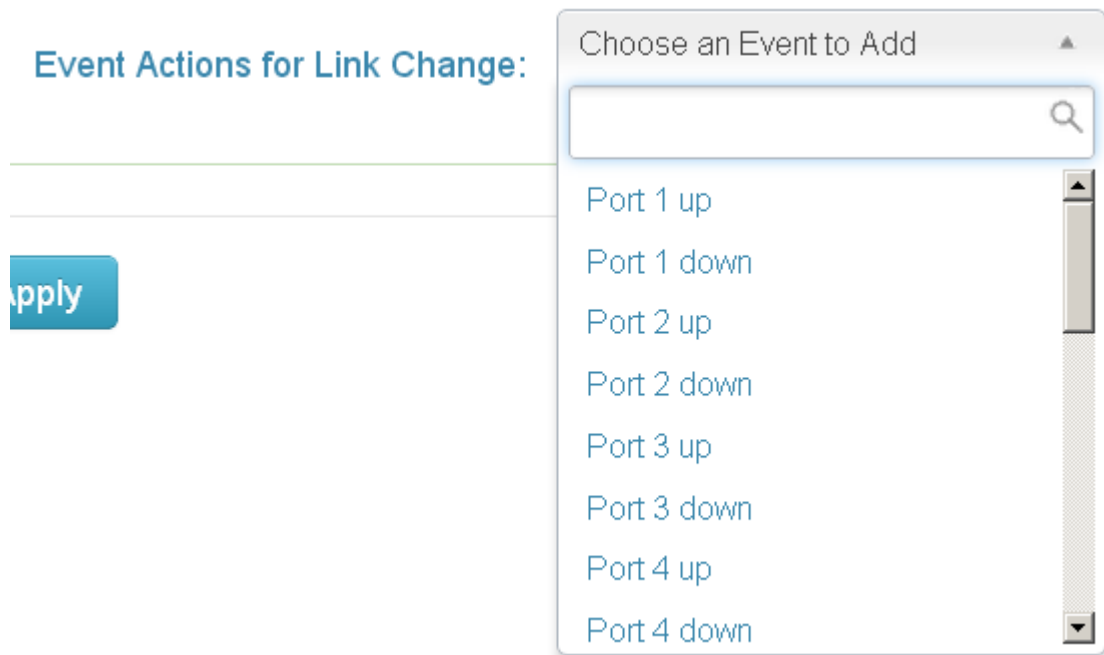

6.6 Ports

Device Settings

Port No.	Type	Description	Enabled	Flow Control	Speed
1	100TX	<input type="text" value="Port 1"/>	<input checked="" type="checkbox"/>	<input type="checkbox"/>	Auto <input type="button" value="v"/>
2	100TX	<input type="text" value="Port 2"/>	<input checked="" type="checkbox"/>	<input type="checkbox"/>	Auto <input type="button" value="v"/>

6.6.1 Device Settings

In Port control you can configure the settings of each port to control the connection parameters, and the status of each port is listed beneath.

- **Port No.:** The port number which you want to be configured.
- **Type:** Current port state.
- **Description:** Port description.
- **Enables:** enable/disable the switch port.
- **Flow Control:** Whether or not the receiving node sends feedback to the sending node is determined by this item. When enabled, once the device exceeds the input data rate of another device, the receiving device will send a PAUSE frame which halts the transmission of the sender for a specified period of time. When disabled, the receiving device will drop the packet if too much to process.
- **Speed:** It can be set as auto or set speed and negotiated way manually.
- Click to have the configuration take effect.

Port Status

Port No.	Type	Link	State	Speed	Flow Control
1	100TX	up	Enable	100 Full	Disable
2	100TX	down	Enable	N/A	N/A

6.6.2 Status

It will show you the status of port configuration setting.

Port Statistic

Port	Type	Link	State	TX Good	TX Bad	RX Good	RX Bad	TX Abort	Collision	Drop	RX BCAST	RX MCAST	TX MCAST
1	DSFP	Down	Enable	0	0	0	0	0	0	0	0	0	0
2	DSFP	Down	Enable	0	0	0	0	0	0	0	0	0	0
3	DSFP	Down	Enable	0	0	0	0	0	0	0	0	0	0
4	DSFP	Down	Enable	0	0	0	0	0	0	0	0	0	0

6.6.3 Statistics

The following chart provides the current statistic information which displays the real-time packet transfer status for each port. The user might use the information to plan and implement the network, or check and find the problem when the collision or heavy traffic occurs.

- **Port:** The port number.
- **Type:** Displays the current speed of connection to the port.
- **Link:** The status of linking—'Up' or 'Down'.
- **State:** It's set by Port Control. When the state is disabled, the port will not transmit or receive any packet.
- **Tx Good Packet:** The counts of transmitting good packets via this port.
- **Tx Bad Packet:** The counts of transmitting bad packets (including undersize [less than 64 octets], oversize, CRC Align errors, fragments and jabbers packets) via this port.
- **Rx Good Packet:** The counts of receiving good packets via this port.
- **Rx Bad Packet:** The counts of receiving good packets (including undersize [less

than 64 octets], oversize, CRC error, fragments and jabbers) via this port.

- **Tx Abort Packet:** The aborted packet while transmitting.
- **Packet Collision:** The counts of collision packet.
- **Packet Dropped:** The counts of dropped packet.
- **Rx Bcast Packet:** The counts of broadcast packet received.
- **Rx Mcast Packet:** The counts of multicast packet received.
- **Tx Mcast Packet:** The counts of multicast packet transmitted
- Click button to clean all counts.

Port Mirroring

Direction	Destination	Mirror From
RX	<input type="text" value="Port 1"/>	<input type="text" value="Choose ports"/>
TX	<input type="text" value="Port 1"/>	<input type="text" value="Choose ports"/>

6.6.4 Mirroring

The Port mirroring is a method for monitor traffic in switched networks. Traffic through ports can be monitored by one specific port, which means traffic goes in or out monitored (source) ports will be duplicated into mirror (destination) port.

- **Destination :**You can set which switch port will be responsible for collecting the data which was duplicated from the source port.
- **Mirrpr From:**You can set which switch port will be duplicated then send to the destination port.

Note1 : All the duplicated data of the source port can be separated with RX and TX, if you want to collect multi-source ports at the same time, you can assign the Tx of one destination port to be responsible for collecting all the Tx data of source ports and assign another RX of destination port to be responsible for collecting all the Rx data of source ports.

- And then, click button.

Rate Limiting

Port	Ingress	Egress
1	<div style="display: flex; align-items: center;"><div style="margin-right: 10px;">Unicast</div><div style="margin-right: 10px;">Multicast</div><div style="margin-right: 10px;">Broadcast</div><div style="border: 1px solid #ccc; padding: 2px 10px;">0</div><div style="margin: 0 5px;">kbps</div><div style="margin-left: 10px;">0%</div></div>	<div style="border: 1px solid #ccc; padding: 2px 10px;">0</div> kbps 0%
2	<div style="display: flex; align-items: center;"><div style="margin-right: 10px;">Unicast</div><div style="margin-right: 10px;">Multicast</div><div style="margin-right: 10px;">Broadcast</div><div style="border: 1px solid #ccc; padding: 2px 10px;">0</div><div style="margin: 0 5px;">kbps</div></div>	<div style="border: 1px solid #ccc; padding: 2px 10px;">0</div> kbps

6.6.5 Rate Limiting

You can set up every port's bandwidth rate and frame limitation type.

All the ports support port egress rate control. For example, assume port 1 is 10Mbps, users can set its effective egress rate is 1Mbps, ingress rate is 500Kbps. The switch performs the ingress rate by packet counter to meet the specified rate

- Click to apply the settings

6.6.6 Loop Protection

Loop Protection

Config Status

Enable Loop Protection

Interval

Shutdown

[Apply](#)

The loop Protection is used to detect the presence of traffic. When switch receives packet's (looping detection frame) MAC address the same as oneself from port, show Loop Protection happens. The port will be locked when it received the looping Protection frames.

■ **Enable Loop Protection:**

Control whether loop protections is enabled (as a whole). .

■ **Interval:**

The interval between each loop protection PDU sent on each port. valid values are 1 to 10 seconds.

■ **Shutdown :**

The period (in seconds) for which a port will be kept disabled in the event of a loop is detected (and the port action shuts down the port). Valid values are 0 to 604800 seconds (7 days). A value of zero will keep a port disabled (until next device restart).

6.7 Power over Ethernet

This segment shows the PoE(Power over Ethernet) function complying with IEEE 802.3af/at standards

6.7.1 Configuration

System				
Maximum Power Available: <input type="text" value="250"/> W				

Ports				
Port No.	Enabled	Scheduling	Priority	Power Limit(<= 36000)
1	<input checked="" type="checkbox"/>	<input type="checkbox"/>	Low	<input type="text" value="36000"/> mW
2	<input checked="" type="checkbox"/>	<input type="checkbox"/>	Low	<input type="text" value="36000"/> mW
3	<input checked="" type="checkbox"/>	<input type="checkbox"/>	Low	<input type="text" value="36000"/> mW
4	<input checked="" type="checkbox"/>	<input type="checkbox"/>	Low	<input type="text" value="36000"/> mW
5	<input checked="" type="checkbox"/>	<input type="checkbox"/>	Low	<input type="text" value="36000"/> mW
6	<input checked="" type="checkbox"/>	<input type="checkbox"/>	Low	<input type="text" value="36000"/> mW
7	<input checked="" type="checkbox"/>	<input type="checkbox"/>	Low	<input type="text" value="36000"/> mW
8	<input checked="" type="checkbox"/>	<input type="checkbox"/>	Low	<input type="text" value="36000"/> mW

■ Maximum Power Available:

This function will limit the total power consumption and cannot exceed 250W.

■ Port No.

The number of each PoE port

■ Enable

Enable/disable the PoE function of each PoE port

■ Priority

Set the priority of power supply, if the total power consumption of all PoE ports was over the value of maximum power available, the switch will offer the power to the high priority PoE port and stop to supply power to the low priority PoE port.

■ Power Limit

Set the Maximum power of each PoE port

6.7.2 Status

Power over Ethernet Status

⚡ System		
Power Consumption	Main Voltage	Main Current
1W	47.7V	0.021A

⚡ Ports							
Port No.	Link	State	Temperature (°C)	Current (mA)	Voltage (V)	Power (W)	Determined Class
1	Up	On	41	44	38.6	1.7	1
2	Down	Detecting	41	0	0	0	None
3	Down	Detecting	41	0	0	0	None
4	Down	Detecting	41	0	0	0	None
5	Down	Detecting	41	0	0	0	None
6	Down	Detecting	41	0	0	0	None
7	Up	Detecting	41	0	0	0	None
8	Down	Detecting	41	0	0	0	None

■ Power Consumption:

Total power consumption of all PoE ports

■ Main Voltage:

The input voltage for PoE power source

■ Main Current

The input current for PoE power source

■ Port No.

The number of each PoE port.

■ Link

The connection status of each PoE port.

■ State

The PoE state of the end device.(Unknown means the end device is none-PD device)

■ **Temperature**

Temperature of PoE chipset

■ **Current**

Output current of each PoE port

■ **Voltage**

Output Voltage of each PoE port

■ **Power**

Power consumption of each PoE port

■ **Detection Class**

The PoE class of each PD device where connects with switch.

Class	Usage	Classification current [mA]	Power range [Watt]	Class description
0	Default	0–4	0.44–12.94	Classification unimplemented
1	Optional	9–12	0.44–3.84	Very Low power
2	Optional	17–20	3.84–6.49	Low power
3	Optional	26–30	6.49–12.95	Mid power
4	Valid for 802.3at (Type 2) devices, not allowed for 802.3af devices	36–44	12.95–25.50	High power

Note:

802.3af send 15.4W; receive 12.95W ~48VDC

802.3at send 30.0W; receive 25.50W ~54VDC

Standard IEEE 802.3af		Standard IEEE 802.3at (4-pairs double power- UPoE)	
CLASS	PSE (W)	CLASS	PSE (W)
0	15.4	0	30 or 60
1	4	1	4
2	7	2	7
3	15.4	3	15.4
4	Treat as 0	4	30 or 60

6.7.3 Detection

The PoE detection function is to detect whether the connected PD is still alive by pinging the IP address. Should the PD is not responding, the switch can be set for consequence action such as rebooting PD etc. Note: The PD must have IP address.

Device Detection

Ports							
No.	Enabled	IP address	Interval	Retry Time	Failure Log	Failure Action	Reboot Time
1	<input checked="" type="checkbox"/>	192.168.16.100	30 sec(s)	1	error=0, total=0	Restart For...	3 sec(s)
2	<input type="checkbox"/>	0.0.0.0	30 sec(s)	1	error=0, total=0	Nothing Power Down Power On Restart Forever Restart Once	3 sec(s)
3	<input type="checkbox"/>	0.0.0.0	30 sec(s)	1	error=0, total=0	Nothing	3 sec(s)
4	<input type="checkbox"/>	0.0.0.0	30 sec(s)	1	error=0, total=0	Nothing	3 sec(s)
5	<input type="checkbox"/>	0.0.0.0	30 sec(s)	1	error=0, total=0	Nothing	3 sec(s)
6	<input type="checkbox"/>	0.0.0.0	30 sec(s)	1	error=0, total=0	Nothing	3 sec(s)
7	<input type="checkbox"/>	0.0.0.0	30 sec(s)	1	error=0, total=0	Nothing	3 sec(s)
8	<input type="checkbox"/>	0.0.0.0	30 sec(s)	1	error=0, total=0	Nothing	3 sec(s)

- **No.**

The number of PoE port

- **Enabled**

Enable the PoE port with PoE detection function.

- **IP address**

The IP address of the connected PD.

- **Interval**

How frequent the switch will ping the IP address of PD.

- **Retry Time**

How many times of ping failure the switch will define the PD as dead or failure.

■ **Failure Log**

Failure times of the PD detection.

■ **Failure Action**

When the switch can not detect the PD, there are several failure action to be set as followings:

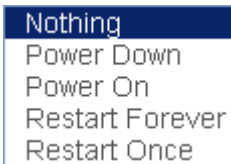

- Nothing: No action
- Power Down: shutdown the power of the PoE port
- Power On: keep the power on with the PoE port
- Restart Forever: Restart the power of the PoE port always.
- Restart Once: only restart the PoE power one time.

■ **Reboot time**

To set the reboot time of PD in order for the switch to check PD connection after PD is completely boot up.

6.7.4 Scheduling

The Poe scheduling is to feed or shut down PoE power over a routine schedule in the following table.

Power Schedule																								
Hour	00	01	02	03	04	05	06	07	08	09	10	11	12	13	14	15	16	17	18	19	20	21	22	23
Sunday	<input type="checkbox"/>	<input type="checkbox"/>	<input type="checkbox"/>	<input type="checkbox"/>	<input type="checkbox"/>	<input type="checkbox"/>	<input type="checkbox"/>	<input type="checkbox"/>	<input type="checkbox"/>	<input type="checkbox"/>	<input type="checkbox"/>	<input type="checkbox"/>	<input type="checkbox"/>	<input type="checkbox"/>	<input type="checkbox"/>	<input type="checkbox"/>	<input type="checkbox"/>	<input type="checkbox"/>	<input type="checkbox"/>	<input type="checkbox"/>	<input type="checkbox"/>	<input type="checkbox"/>	<input type="checkbox"/>	<input type="checkbox"/>
Monday	<input type="checkbox"/>	<input type="checkbox"/>	<input type="checkbox"/>	<input type="checkbox"/>	<input type="checkbox"/>	<input type="checkbox"/>	<input type="checkbox"/>	<input type="checkbox"/>	<input type="checkbox"/>	<input type="checkbox"/>	<input type="checkbox"/>	<input type="checkbox"/>	<input type="checkbox"/>	<input type="checkbox"/>	<input type="checkbox"/>	<input type="checkbox"/>	<input type="checkbox"/>	<input type="checkbox"/>	<input type="checkbox"/>	<input type="checkbox"/>	<input type="checkbox"/>	<input type="checkbox"/>	<input type="checkbox"/>	<input type="checkbox"/>
Tuesday	<input type="checkbox"/>	<input type="checkbox"/>	<input type="checkbox"/>	<input type="checkbox"/>	<input type="checkbox"/>	<input type="checkbox"/>	<input type="checkbox"/>	<input type="checkbox"/>	<input type="checkbox"/>	<input type="checkbox"/>	<input type="checkbox"/>	<input type="checkbox"/>	<input type="checkbox"/>	<input type="checkbox"/>	<input type="checkbox"/>	<input type="checkbox"/>	<input type="checkbox"/>	<input type="checkbox"/>	<input type="checkbox"/>	<input type="checkbox"/>	<input type="checkbox"/>	<input type="checkbox"/>	<input type="checkbox"/>	<input type="checkbox"/>
Wednesday	<input type="checkbox"/>	<input type="checkbox"/>	<input type="checkbox"/>	<input type="checkbox"/>	<input type="checkbox"/>	<input type="checkbox"/>	<input type="checkbox"/>	<input type="checkbox"/>	<input type="checkbox"/>	<input type="checkbox"/>	<input type="checkbox"/>	<input type="checkbox"/>	<input type="checkbox"/>	<input type="checkbox"/>	<input type="checkbox"/>	<input type="checkbox"/>	<input type="checkbox"/>	<input type="checkbox"/>	<input type="checkbox"/>	<input type="checkbox"/>	<input type="checkbox"/>	<input type="checkbox"/>	<input type="checkbox"/>	<input type="checkbox"/>
Thursday	<input type="checkbox"/>	<input type="checkbox"/>	<input type="checkbox"/>	<input type="checkbox"/>	<input type="checkbox"/>	<input type="checkbox"/>	<input type="checkbox"/>	<input type="checkbox"/>	<input type="checkbox"/>	<input type="checkbox"/>	<input type="checkbox"/>	<input type="checkbox"/>	<input type="checkbox"/>	<input type="checkbox"/>	<input type="checkbox"/>	<input type="checkbox"/>	<input type="checkbox"/>	<input type="checkbox"/>	<input type="checkbox"/>	<input type="checkbox"/>	<input type="checkbox"/>	<input type="checkbox"/>	<input type="checkbox"/>	<input type="checkbox"/>
Friday	<input type="checkbox"/>	<input type="checkbox"/>	<input type="checkbox"/>	<input type="checkbox"/>	<input type="checkbox"/>	<input type="checkbox"/>	<input type="checkbox"/>	<input type="checkbox"/>	<input type="checkbox"/>	<input type="checkbox"/>	<input type="checkbox"/>	<input type="checkbox"/>	<input type="checkbox"/>	<input type="checkbox"/>	<input type="checkbox"/>	<input type="checkbox"/>	<input type="checkbox"/>	<input type="checkbox"/>	<input type="checkbox"/>	<input type="checkbox"/>	<input type="checkbox"/>	<input type="checkbox"/>	<input type="checkbox"/>	<input type="checkbox"/>
Saturday	<input type="checkbox"/>	<input type="checkbox"/>	<input type="checkbox"/>	<input type="checkbox"/>	<input type="checkbox"/>	<input type="checkbox"/>	<input type="checkbox"/>	<input type="checkbox"/>	<input type="checkbox"/>	<input type="checkbox"/>	<input type="checkbox"/>	<input type="checkbox"/>	<input type="checkbox"/>	<input type="checkbox"/>	<input type="checkbox"/>	<input type="checkbox"/>	<input type="checkbox"/>	<input type="checkbox"/>	<input type="checkbox"/>	<input type="checkbox"/>	<input type="checkbox"/>	<input type="checkbox"/>	<input type="checkbox"/>	<input type="checkbox"/>

6.8 Topology

This function can help user to build the network topology drawing automatically for the switches that are in closed looped and show the detail information of each switch node by clicking the icon. The topology view drawing can show the backup path with the dot line for overall picture, please remember to enable **LLDP** function before you use this function.

Topology Status

Warning!

Please [Enable LLDP](#) to see topology status

Topology Status

Nodes	
MAC Address	IP

Links		
From	To	Stat

Rings

Topology Status

■ Text View:

Display each switch in your network by text.

The Topology was build with the information from LLDP where can let you see the information from other switches.

■ Nodes:

show the information of each switch like MAC address and IP address.

■ Links:

show the information of each connection .

- **Rings:**

show the information from ITU-Ring function

Topology Status



- **Graphic View:**

Display each switch connection in the network by graphic.

You can see the topology diagram which is assorted by the LLDP information.

- **Physical :**

display the physical connection of network .

- **Ring :**

Beside the physical connection, also show the information about ITU-Ring

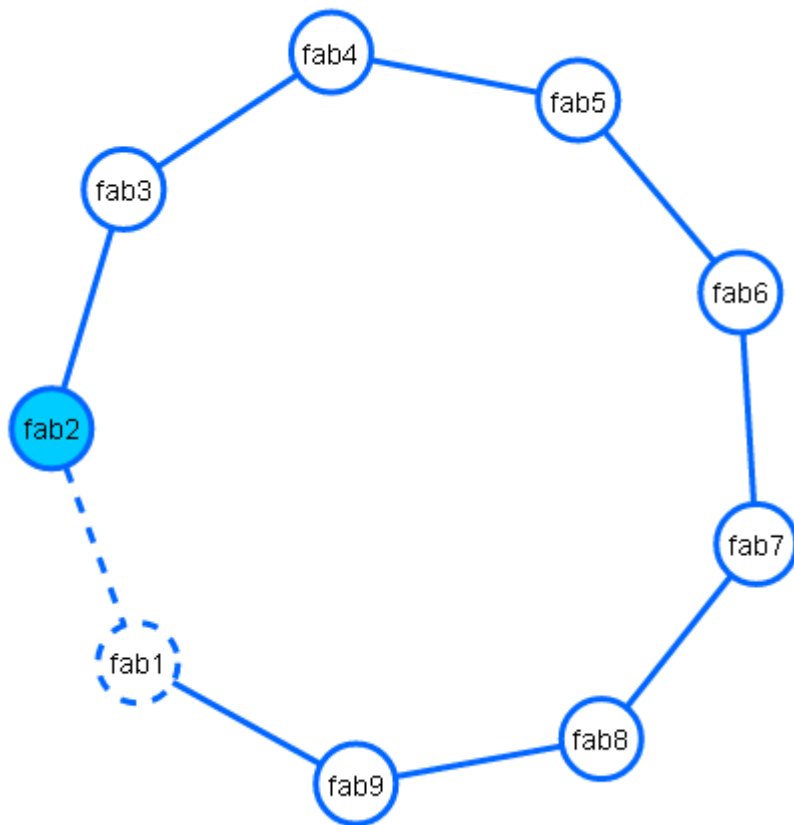

■ **Demo:**

Demo display each topology in different **connection**.

6.9 QoS

QoS Configuration

QoS Policy:

Use weighted fair queuing scheme

Priority Type

Weighted Fair Queue Ratio

Traffic 0	Traffic 1	Traffic 2	Traffic 3	Traffic 4	Traffic 5	Traffic 6	Traffic 7
<input type="text" value="1"/>	<input type="text" value="1"/>	<input type="text" value="1"/>	<input type="text" value="1"/>	<input type="text" value="1"/>	<input type="text" value="1"/>	<input type="text" value="1"/>	<input type="text" value="1"/>

Apply

Quality of Service (QoS) is the ability to provide different priority to different applications, users or data flows, or to guarantee a certain level of performance to a data flow. QoS guarantees are important if the network capacity is insufficient, especially for real-time streaming multimedia applications such as voice over IP or Video Teleconferencing, since these often require fixed bit rate and are delay sensitive, and in networks where the capacity is a limited resource, for example in cellular data communication. In the absence of network congestion, QoS mechanisms are not required.

6.9.1 QoS Policy

■ Using the weight fair queue scheme

The switch will follow 8:4:2:1 rate to process priority queue from High to lowest queue. For example, while the system processing, 1 frame of the lowest queue, 2 frames of the low queue, 4 frames of the middle queue, and 8 frames of the high queue will be processed at the same time in accordance with the 8,4,2,1 policy rule.

■ Priority Type

There are 5 priority type selections available—**Port-based**, **TOS only**, **COS only**, **TOS first**, and **COS first**. Disable means no priority type is selected.

- **Port Base Priority**

Configure the priority level for each port. With the drop-down selection item of **Priority Type** above being selected as Port-based, this control item will then be available to set the queuing policy for each port.

- **Cos**

Set up the COS priority level. With the drop-down selection item of **Priority Type** above being selected as COS only/COS first, this control item will then be available to set the queuing policy for each port.

- **Tos**

ToS priority: the system provides 0~63 ToS priority level. Each level has 8 type of priority - 0~7. The default value is "1" priority for each level. When the IP packet is received, the system will check the ToS level value in the IP packet has received. For example: user set the ToS level 25 is 7. The port 1 is following the ToS priority policy only. When the packet received by port 1, the system will check the ToS value of the received IP packet. If the ToS value of received IP packet is 25(priority = 7), and then the packet priority will have highest priority.

Click  to have the configuration take effect.

6.10 Security

MAC Address Tables

Static MAC Addresses | **MAC Filtering** | All MAC Addresses

0 static MAC address entries

MAC Address	VLAN ID	Port No	
:MAC address Please enter a valid MAC address.	1	Port 1	+

Apply

6.10.1 MAC Address Tables

Use the MAC address table to ensure the port security.

■ Static MAC Address

You can add a static MAC address; it remains in the switch's address table, regardless of whether the device is physically connected to the switch. This saves the switch from having to re-learn a device's MAC address when the disconnected or powered-off device is active on the network again. You can add / modify / delete a static MAC address. MAC Address: Enter the MAC address of the port that should permanently forward traffic, regardless of the device network activity. VLAN ID : Entering the VLAN ID. Port No : pull down the selection menu to select the port number.

■ MAC Filtering

By filtering MAC address, the switch can easily filter pre-configure MAC address and reduce the un-safety. You can add and delete filtering MAC address. MAC Address: Enter the MAC address that you want to filter.

■ All MAC Addresses

you can view the port that connected device's MAC address and related device's MAC address.

6.10.2 Access Control List

The switch access control list (ACL) is probably the most commonly used object in the OSI layer 2 and 3. It is used for access filtering. The ACLs are divided into MAC and IP filtering.

6.10.2.1 ACL with Layer2 (MAC)

■ No:

The number of ACL record.

■ Port:

assign the port which you want to enable the ACL function.

■ Direction:

Let the switch check the destination address or source address of packet.

Address: assign the MAC address which you want to deny.

Mask: set the mask to filter the MAC range.

No	Port	Direction	Address	Mask	Action
1	Port 1	Source	00:00:00:00:00:00	ff:ff:fe:00:00	Deny

6.10.2.2 ACL with Layer3 (IP)

■ No:

The number of ACL record.

■ Port:

assign the port which you want to enable the ACL function.

■ Direction:

let the switch check the destination address or source address of packet.

■ Address:

assign the IP address which you want to deny.

■ Mask:

set the mask to filter the IP range.

No	Port	Direction	Address	Mask	Action
1	Port 1	Source	192.168.16.1	255.255.255.0	Deny

6.10.3 IEEE 802.1X Radius Server

802.1X is an IEEE authentication specification which prevents the client from accessing a wireless access point or wired switch until it provides authority, like the user name and password that are verified by an authentication server (such as RADIUS server).

After enabling the IEEE 802.1X function, you can configure the parameters of this function.

- **Server IP**

Assign the RADIUS Server IP address.

- **Server Port**

Set the UDP destination port for authentication requests to the specified RADIUS Server.

- **Shared Key**

Set an encryption key for using during authentication sessions with the specified RADIUS server. This key must match the encryption key used on the RADIUS Server.

- **NAS Identifier**

Set the identifier for the RADIUS client.

- **Enable on Ports**

Enable or disable 802.1x protocol.

IP Security

Enable IP Security

Apply

6.10.4 IP Security

IP security function allows user to assign 20 specific IP addresses that have permission to access the switch through the web browser for the securing switch management.

■ Enable IP Security

When this option is in Enable mode, the Enable Web Server and Enable Telnet Server and Enable SSH Server check boxes will then be available.

■ Enable Web Server

When this check box is checked, the IP addresses among IP permit list will be allowed to access via web service.

■ Enable Telnet Server

When this check box is checked, the IP addresses among IP permit list will be allowed to access via telnet service.

■ Enable SSH Server

When this check box is checked, the IP addresses among IP permit list will be allowed to access via ssh service.

■ IP permit list

Assign up to 20 specific IP address. Only these 10 IP address can access and manage the switch through the Web browser

802.1Q VLAN Config

Management VLAN ID

Port No.	Link Type	PVID	Tagged VLANs
1	Access	<input type="text" value="1"/>	<input type="text"/>
2	Access	<input type="text" value="1"/>	<input type="text"/>
3	Access	<input type="text" value="1"/>	<input type="text"/>
4	Access	<input type="text" value="1"/>	<input type="text"/>
5	Access	<input type="text" value="1"/>	<input type="text"/>

6.11 VLAN

A Virtual LAN (VLAN) is a logical network grouping that limits the broadcast domain, which would allow you to isolate network traffic, so only the members of the same VLAN will receive traffic from the ones of the same VLAN. Basically, creating a VLAN on a switch is logically equivalent of reconnecting a group of network devices to another Layer 2 switch. However, all the network devices are still plugged into the same switch physically.

6.11.1 802.1Q VLAN Config

802.1Q VLAN Config

Management VLAN ID

Port No.	Link Type	PVID	Tagged VLANs
1	Access	<input type="text" value="1"/>	<input type="text"/>
2	Access	<input type="text" value="1"/>	<input type="text"/>
3	Access	<input type="text" value="1"/>	<input type="text"/>
4	Access	<input type="text" value="1"/>	<input type="text"/>
5	Access	<input type="text" value="1"/>	<input type="text"/>
6	Access	<input type="text" value="1"/>	<input type="text"/>
7	Access	<input type="text" value="1"/>	<input type="text"/>
8	Access	<input type="text" value="1"/>	<input type="text"/>

■ Management VLAN ID:

This will set which VLAN group can access the switch, the default “0” means all VLAN group, this limitation will not support port based VLAN.

■ Link Type:

There are 3 types of link type.

1. Access Link: A segment which provides the link path for one or more stations to the VLAN-aware device. An Access Port (untagged port), connected to the access link, has an untagged VID (also called PVID). After an untagged frame gets into the access port, the switch will insert a four-byte tag in the frame. The contents of the last 12-bit of the tag is untagged VID. When this frame is sent out through any of the access port of the same PVID, the switch will remove the tag from the frame to recover it to what it was. Those ports of the same untagged VID are regarded as the same VLAN group members.

Note: Because the access port doesn't have an understanding of tagged frame, the column field of Tagged VID is not available.

2. Trunk Link: A segment which provides the link path for one or more VLAN-aware devices (switches). A Trunk Port, connected to the trunk link, has an understanding of tagged frame, which is used for the communication among VLANs across switches. Which frames of the specified VIDs will be forwarded depends on the values filled in the Tagged VID column field. Please insert a comma between two VIDs.

Note:

A trunk port doesn't insert tag into an untagged frame, and therefore the untagged VID column field is not available.

It's not necessary to type '1' in the tagged VID. The trunk port will forward the frames of VLAN 1.

The trunk port has to be connected to a trunk/hybrid port of the other switch. Both the tagged VID of the two ports have to be the same.

3. Hybrid Link: A segment which consists of Access and Trunk links. The hybrid port has both the features of access and trunk ports. A hybrid port has a PVID belonging to a particular VLAN, and it also forwards the specified tagged-frames

for the purpose of VLAN communication across switches.

■ PVID

This column field is available when Link Type is set as Access Link and Hybrid Link. Assign a number in the range between 1 and 4094.

■ Tagged VID:

This column field is available when Link Type is set as Trunk Link and Hybrid Link. Assign a number in the range between 1 and 4094.

802.1Q VLAN Status

VLAN ID	Port Members
1	Port 1 U Port 2 U Port 3 U Port 4 U Port 5 U Port 6 U Port 7 U Port 8 U Port 9 U Port 10 U Port 11 T Port 12 T
2	Port 1 U Port 2 U Port 11 T Port 12 T
3	Port 1 U Port 11 T Port 12 T

6.11.2 Status

You can see the status of each VLAN group in here.

Multicast VLAN Registration

[New MVR](#)

VLAN ID	Multicast Address	Port Members	Delete MVR
---------	-------------------	--------------	------------

Apply

6.12 MVR

The MVR feature enables multicast traffic forwarding on the Multicast VLAN. In a multicast television application, a PC or a television with a set-top box can receive the multicast stream. Multiple set-top boxes or PCs can be connected to one subscriber port, which is a switch port configured as an MVR receiver port. When a subscriber selects a channel, the set-top box or PC sends an IGMP join message to Switch A in order to join the appropriate multicast. Uplink ports that send and receive multicast data to and from the multicast VLAN are called MVR source ports.

■ VLAN ID

Specify the Multicast VLAN ID.

■ Multicast Addresses

Multicast Addresses of the group displayed.

■ Port Members

Ports under this group.

Multicast VLAN Registration

VLAN ID	Multicast Address	Port Members
		<input type="text" value="Port 1 x"/>

Apply

LLDP Configuration

Enabled

TX Interval(secs)

Port NO	Port ID	Mode
1	1	Both <input type="text"/>
2	2	Both <input type="text"/>

6.12 LLDP

Link Layer Discovery Protocol (LLDP) is defined in the IEEE802.1AB, it is an emerging standard which provides a solution for the configuration issues caused by expanding LANs. LLDP specifically defines a standard method for Ethernet network devices such as switches, routers and wireless LAN access points to advertise information about themselves to other nodes on the network and store the information they discover. LLDP runs on all 802 media. The protocol runs over the data-link layer only, allowing two systems running different network layer protocols to learn about each other.

6.12.1 LLDP Configuration

■ Enabled

Enabled The switch will send out LLDP information, and will analyze LLDP information received from neighbours.

■ Tx Interval

The switch periodically transmits LLDP frames to its neighbours for having the network discovery information up-to-date. The interval between each LLDP frame is determined by the **Tx Interval** value. Valid values are restricted to 5 - 32768 seconds.

The LLDP port settings relate to the currently selected stack unit, as reflected by the page header.

■ Port No

The switch port number of the logical LLDP port.

■ Port Id

Enter characters to be id name for the logical LLDP port.

■ Mode

Select LLDP mode.

Rx only The switch will not send out LLDP information, but LLDP information from neighbor units is analyzed.

Tx only The switch will drop LLDP information received from neighbors, but will send out **LLDP information**.

Disabled The switch will not send out LLDP information, and will drop LLDP information received from neighbors.

Both The switch will send out LLDP information, and will analyze LLDP information received from neighbors.

LLDP Neighbor Information

Identification						
Local Port	Chassis ID	Port ID	Port Description	System Name	System Capability	Management Address

6.12.2 LLDP Neighbor

This page provides a status overview for all LLDP neighbors. The displayed table contains a row for each port on which an LLDP neighbor is detected. The columns hold the following information:

■ Local Port

The port on which the LLDP frame was received.

■ Chassis ID

The **Chassis ID** is the identification of the neighbor's LLDP frames.

■ Remote Port ID

The **Remote Port ID** is the identification of the neighbor port.

■ Port Description

Port Description is the port description advertised by the neighbor unit.

■ System Name

System Name is the name advertised by the neighbour unit.

■ **System Capabilities**

System Capabilities describes the neighbour unit's capabilities. The possible capabilities are:

1. Other
2. Repeater
3. Bridge
4. WLAN Access Point
5. Router
6. Telephone
7. DOCSIS cable device
8. Station only
9. Reserved

When a capability is enabled, the capability is followed by (+). If the capability is disabled, the capability is followed by (-).

■ **Management Address**

Management Address is the neighbor unit's address that is used for higher layer entities to assist discovery by the network management. This could for instance hold the neighbor's IP address.

LLDP Neighbor Information

Total									
Neighbors Aged Out	Neighbors Add	Neighbors Delete	Frames Discarded	Frames Received In Error	Frames In	Frames Out	TLVs Discarded	TLVs Unrecognized	
0	0	0	0	0	0	0	0	0	0

Ports									
1	0	0	0	0	0	0	0	0	0
2	0	0	0	0	0	0	0	0	0

6.12.3 LLDP Statistics

This page provides an overview of all LLDP traffic.

Two types of counters are shown. **Total** are counters that refer to the whole stack, switch, while **Port** refer to per port counters for the currently selected switch.

6.12.3.1 Total

- **Neighbours Aged Out**

Shows the number of entries deleted due to Time-To-Live expiring.

- **Neighbours Added**

Shows the number of new entries added since switch reboot.

- **Neighbours Deleted**

Shows the number of new entries deleted since switch reboot.

- **Frames Discarded**

If an LLDP frame is received on a port, and the switch's internal table has run full, the LLDP frame is counted and discarded. This situation is known as "Too Many Neighbours" in the LLDP standard. LLDP frames require a new entry in the table when the Chassis ID or Remote Port ID is not already contained within the table. Entries are removed from the table when a given port's link is down, an LLDP shutdown frame is received, or when the entry ages out.

■ **Frames Received In Error**

The number of received LLDP frames containing some kind of error.

■ **Frames In**

The number of LLDP frames received on the port.

■ **Frames Out**

The number of LLDP frames transmitted on the port.

■ **TLVs Discarded**

Each LLDP frame can contain multiple pieces of information, known as TLVs (TLV is short for "Type Length Value"). If a TLV is malformed, it is counted and discarded.

TLVs Unrecognized

The number of well-formed TLVs, but with an unknown type value.

■ **Ports**

The displayed table contains a row for each port. The columns hold the following information:

■ **Port**

The port on which LLDP frames are received or transmitted.

■ **Neighbors Aged Out**

Shows the number of entries deleted due to Time-To-Live expiring.

■ **Neighbors Added**

Shows the number of new entries added since switch reboot.

■ **Neighbors Deleted**

Shows the number of new entries deleted since switch reboot.

■ **Frames Discarded**

If an LLDP frame is received on a port, and the switch's internal table has run full, the LLDP frame is counted and discarded. This situation is known as "Too Many Neighbors" in the LLDP standard. LLDP frames require a new entry in the table when the Chassis ID or Remote Port ID is not already contained within the table. Entries are removed from the table when a given port's link is down, an LLDP shutdown frame is received, or when the entry ages out.

■ **Frames Received In Error**

The number of received LLDP frames containing some kind of error.

■ **Frames In**

The number of LLDP frames received on the port.

- **Frames Out**

The number of LLDP frames transmitted on the port.

- **TLVs Discarded**

Each LLDP frame can contain multiple pieces of information, known as TLVs (TLV is short for "Type Length Value"). If a TLV is malformed, it is counted and discarded.

- **TLVs Unrecognized**

The number of well-formed TLVs, but with an unknown type value.

6.13 CDP

The **Cisco Discovery Protocol (CDP)** is a proprietary data link layer protocol developed by Cisco. It is used to share information about other directly connected Cisco equipment, such as the OS version and IP address

CDP Configuration Device Settings

CDP Enable:

CDP timer(secs)

CDP holdtime(secs)

Port	Enabled
1	<input checked="" type="checkbox"/>
2	<input checked="" type="checkbox"/>
3	<input checked="" type="checkbox"/>
4	<input checked="" type="checkbox"/>
5	<input checked="" type="checkbox"/>
6	<input checked="" type="checkbox"/>
7	<input checked="" type="checkbox"/>

6.13.1 CDP Configuration Device Settings

■ CDP Enabled

Enabled the switch will send out CDP information, and will analyze CDP information received from neighbors.

■ Tx Interval(secs)

The switch periodically transmits CDP frames to its neighbours for having the network discovery information up-to-date. The interval between each CDP frame is determined by the **Tx Interval** value. Valid values are restricted to 5 - 32768 seconds.

■ Tx Holdtime(secs)

Each CDP frame contains information about how long the information in the CDP frame shall be considered valid. The holdtime between each CDP frame is determined by the **Tx Holdtime** value. Valid values are restricted to 5 - 32768 seconds.

6.13.2 CDP Port Configuration

■ Port

The switch port number of the logical CDP port.

■ Enabled

The switch will send out CDP information, and will analyze CDP information received from neighbors.

CDP Status

Statistics	
Total Packets Output	Total Packets Input
0	0

Neighbors						
Local Port NO	CDP Version	Ageout TTL	Device ID	Platform	Software Version	Addresses

6.13.3. CDP Status

■ Statistics

Total Packets Output

The number of CDP frames transmitted on the switch.

Total Packets Input

The number of CDP frames received on the switch.

■ Neighbors

The displayed table contains a row for each port on which an CDP neighbour is detected. The columns hold the following information:

Local Port

The port on which the CDP frame was received.

Version

Version is the CDP version advertised by the neighbor unit.

Ageout TTL

Ageout TTL is the ageout Time-To-Live advertised by the neighbor unit.

Device ID

The Device ID is the identification of the neighbor's CDP frames.

Platform

Platform is the description advertised by the neighbor unit.

Software Version

Software Version is the software version advertised by the neighbor unit.

Addresses

Addresses is the neighbour unit's address that is used for higher layer entities to assist discovery by the network management. This could for instance hold the neighbor's IP address.

6.14 IGMP Snooping

The switch support IP multicast, you can enable IGMP protocol on web management's switch setting configuration page, then the IGMP snooping information displays. IP multicast addresses range are from 224.0.0.0 through 239.255.255.255.

IGMP Snooping Configuration

Global Configuration

- Enable Querier
- Enable Snooping
- Flood Well-known Multicast Traffic

VLAN Configuration

ID	Enable Querier	Enable Snooping
1	<input checked="" type="checkbox"/>	<input type="checkbox"/>

Port Related Configuration

Port	Router Port	Fast Leave
1	<input type="checkbox"/>	<input checked="" type="checkbox"/>
2	<input type="checkbox"/>	<input checked="" type="checkbox"/>
3	<input type="checkbox"/>	<input checked="" type="checkbox"/>

6.14.1 IGMP Snooping Configuration

Global Configuration

- Enable Querier
- Enable Snooping
- Flood Well-known Multicast Traffic

Port Related Configuration

Port	Router Port	Fast Leave
1	<input type="checkbox"/>	<input checked="" type="checkbox"/>
2	<input type="checkbox"/>	<input checked="" type="checkbox"/>
3	<input type="checkbox"/>	<input checked="" type="checkbox"/>

6.14.1.1 Global Configuration

- **Enable Query:** enable or disable the IGMP query function. The IGMP query information will be displayed in IGMP status section.
- **Enable Snooping:** enable or disable the IGMP protocol.
- **Flood Well-known Multicast traffic:** let the switch know how to process the Multicast data stream which was unregistered with IGMP Query.
-

6.14.1.2 Port Related Configuration

■ Port

The switch port number of the logical port.

■ Router Port

Specify which ports act as router ports. A router port is a port on the Ethernet switch that leads towards the Layer 3 multicast device or IGMP querier.

If an aggregation member port is selected as a router port, the whole aggregation will act as a router port.

■ Fast Leave

Enable the fast leave on the port.

IGMP Snooping Status

Statistics

VLAN ID	Status Querier	Querier Transmitted	Querier Received	V1 Reports Received	V2 Reports Received	V3 Reports Received	V2 Leave Received
0	true	0	0	0	0	0	0

Clear

IGMP Groups

false

Clear

6.14.2 IGMP Snooping Status

6.14.2.1 Statistics

■ VLAN ID

The VLAN ID of the entry.

■ Status Querior

Shows the Querior status is "ACTIVE" or "IDLE".

"DISABLE" denotes the specific interface is administratively disabled.

■ Queries Transmitted

The number of Transmitted Queries.

■ Queries Received

The number of Received Queries.

■ V1 Reports Received

The number of Received V1 Reports.

■ V2 Reports Received

The number of Received V2 Reports.

- **V3 Reports Received**

The number of Received V3 Reports.

- **V2 Leaves Received**

The number of Received V2 Leaves.

- **IGMP Groups**

Entries in the IGMP Group Table are shown on this page.

- **VLAN ID**

VLAN ID of the group.

- **Multicast Addresses**

Group address of the group displayed.

- **Port Members**

Ports under this group.

- **Membership Interval**

The group hold aging out TTL

MSTP Global Configuration

Mode	<input type="text" value="MSTP"/>
Name	<input type="text" value="REGION1"/>
Revision	<input type="text" value="0"/>
Max Age	<input type="text" value="20"/>
Forward Delay	<input type="text" value="15"/>
Max Hops	<input type="text" value="20"/>

Apply

6.15 MSTP

The section describes that how to configure the Spanning Tree Bridge and STP System settings. It allows you to configure STP System settings are used by all STP Bridge instance in the Switch.

6.15.1. MSTP Global Configuration

■ Mode

Show the STP protocol version setting. Valid values are STP, RSTP and MSTP.

■ Name

The name identifying the VLAN to MSTI mapping. Bridges must share the name and revision (see below), as well as the VLAN-to-MSTI mapping configuration in order to share spanning trees for MSTI's (Intra-region). The name is at most 32 characters.

■ Revision

The revision of the MSTI configuration named above. This must be an integer between 0 and 65535.

■ Forward Delay

The delay used by STP Bridges to transit Root and Designated Ports to Forwarding (used in STP compatible mode). Valid values are in the range 4 to 30 seconds.

■ Max Age

The maximum age of the information transmitted by the Bridge when it is the Root Bridge. Valid values are in the range 6 to 40 seconds, and MaxAge must be $\leq (\text{FwdDelay}-1)*2$.

■ Maximum Hop Count

This defines the initial value of remaining Hops for MSTI information generated at the boundary of an MSTI region. It defines how many bridges a root bridge can distribute its BPDU information to. Valid values are in the range 6 to 40 hops.

6.15.2 How to enable MSTP

6.15.2.1 Enter MSTP → CIST Settings , press icon to enable MSTP

PS: (The default was disable with all ports)

The screenshot shows a network configuration interface. On the left is a navigation menu with categories: QoS, Security, VLAN, MVR, LLDP, IGMP Snooping, CDP, MSTP, Aggregation, PTP, and G 8032 FRPS. The MSTP section is expanded, showing sub-items: Global Configuration, CIST Settings, MSTI Settings, Bridge Status, and Port Status. The main area displays a 'Port Configuration' table. Above the table, there is a 'Priority' input field with the value 32768 and a button labeled 'Enable STP on all ports' with a checkmark icon. The table has columns: Port NO, Enable STP, Path Cost, Priority, Edge Mode, and P2P Mode. The 'Enable STP' column for all 10 ports shows 'NO'. The 'Path Cost' column for all ports shows '0'. The 'Priority' column for all ports shows '128'. The 'Edge Mode' column for all ports shows 'Force Enabled'. The 'P2P Mode' column for all ports shows 'Force Enabled'.

Port NO	Enable STP	Path Cost	Priority	Edge Mode	P2P Mode
1	NO	0	128	Force Enabled	Force Enabled
2	NO	0	128	Force Enabled	Force Enabled
3	NO	0	128	Force Enabled	Force Enabled
4	NO	0	128	Force Enabled	Force Enabled
5	NO	0	128	Force Enabled	Force Enabled
6	NO	0	128	Force Enabled	Force Enabled
7	NO	0	128	Force Enabled	Force Enabled
8	NO	0	128	Force Enabled	Force Enabled
9	NO	0	128	Force Enabled	Force Enabled
10	NO	0	128	Force Enabled	Force Enabled

6.15.2.2 Check the status of STP, all ports should display “Yes”

- Security
- VLAN
- MVR
- LLDP
- IGMP Snooping
- CDP
- MSTP**
- Global Configuration
- CIST Settings
- MSTI Settings
- Bridge Status
- Port Status
- Aggregation
- PTP
- G 8032 FRPS

Port Configuration

Disable STP on all ports

Port NO	Enable STP	Path Cost	Priority	Edge Mode	P2P Mode
1	YES	0	128	Force Enabled	Force Enabled
2	YES	0	128	Force Enabled	Force Enabled
3	YES	0	128	Force Enabled	Force Enabled
4	YES	0	128	Force Enabled	Force Enabled
5	YES	0	128	Force Enabled	Force Enabled
6	YES	0	128	Force Enabled	Force Enabled
7	YES	0	128	Force Enabled	Force Enabled
8	YES	0	128	Force Enabled	Force Enabled
9	YES	0	128	Force Enabled	Force Enabled
10	YES	0	128	Force Enabled	Force Enabled

6.15.2.3 Remember to press “Apply”

6.15.1.4 Save setting

CIST Settings

Bridge Configuration

VLANs

Priority

Port Configuration

Port NO	Enable STP	Path Cost	Priority	Edge Mode	P2P Mode
Port 1	YES	0	128	Force Enabled	Force Enabled
Port 2	YES	0	128	Force Enabled	Force Enabled
Port 3	YES	0	128	Force Enabled	Force Enabled
Port 4	YES	0	128	Force Enabled	Force Enabled

6.15.3 CIST Settings

■ 6.15.3.1 Bridge configuration

VLANs Mapped

The list of VLANs mapped to the MSTI. The VLANs must be separated with comma and/or space. A VLAN can only be mapped to one MSTI. An unused MSTI should just be left empty. (I.e. not having any VLANs mapped to it.) Unmapped VLANs are mapped to the CIST. (The default bridge instance).

Bridge Priority

Control the bridge priority. Lower numeric values have better priority. The bridge priority plus the MSTI instance number, concatenated with the 6-byte MAC address of the switch forms a Bridge Identifier.

■ 6.15.3.2 Port

Port No

The switch port number of the logical STP port.

Enabled STP

Control whether STP is enabled on this switch port.

Path Cost

Controls the path cost incurred by the port. The Auto setting will set the path cost as appropriate by the physical link speed, using the 802.1D recommended values. Using the Specific setting, a user-defined value can be entered. The path cost is used when establishing the active topology of the network. Lower path cost ports are chosen as forwarding ports in favour of higher path cost ports. Valid values are in the range 1 to 200000000.

Priority

Control the port priority. This can be used to control priority of ports having identical port cost. (See above).

edge_mode

Control whether the oper Edge flag should start as being set or cleared. (The initial oper Edge state when a port is initialized). Control whether the bridge should enable automatic edge detection on the bridge port. This allows oper Edge to be derived from whether BPDU's are received on the port or not.

p2p_mode

Description: Controls whether the port connects to a point-to-point LAN rather than a shared medium. This can be automatically determined, or forced either true or false. Transition to the forwarding state is faster for point-to-point LANs than for shared media.

MSTP MSTI Settings

Instance NO	VLANs	Priority
		<input type="button" value="Add"/>

6.15.4. MSTP MSTI Settings

- **Instance No**

VLANs

The list of VLANs mapped to the MSTI. The VLANs must be separated with comma and/or space. A VLAN can only be mapped to one MSTI. An unused MSTI should just be left empty. (I.e. not having any VLANs mapped to it.) Unmapped VLANs are mapped to the CIST. (The default bridge instance).

Priority

Control the bridge priority. Lower numeric values have better priority. The bridge priority plus the MSTI instance number, concatenated with the 6-byte MAC address of the switch forms a Bridge Identifier.

MSTP Bridges Status

NO	Bridge ID	Root ID	Root Port	Root Cost	Topology State
CIST 0	32768-	32768-	0	0	

6.15.5. MSTP Bridges Status

■ Instance

The Bridge Instance. ex: CIST, MSTI1, ...

■ Bridge ID

The Bridge ID of this Bridge instance.

■ Root ID

The Bridge ID of the currently elected root bridge.

■ Root Port

The switch port currently assigned the root port role.

■ Root Cost

Root Path Cost. For the Root Bridge it is zero. For all other Bridges, it is the sum of the Port Path Costs on the least cost path to the Root Bridge.

■ Topology State

The current state of the Topology Change Flag of this Bridge instance.

■ Topology Change Last

The time since last Topology Change occurred.

Bridge status of all ports

Port 1 as Designated/FORWARDING in CIST	Port 2 as Disabled/BLOCKING in CIST	Port 3 as Disabled/BLOCKING in CIST
Port 4 as Disabled/BLOCKING in CIST	Port 5 as Disabled/BLOCKING in CIST	Port 6 as Disabled/BLOCKING in CIST
Port 7 as Designated/FORWARDING in CIST	Port 8 as Disabled/BLOCKING in CIST	Port 9 as Disabled/BLOCKING in CIST
Port 10 as Disabled/BLOCKING in CIST	Port 11 as Disabled/BLOCKING in CIST	Port 12 as Disabled/BLOCKING in CIST

6.15.6. Bridge status of all ports

- **Port**

The switch port number of the logical STP port.

- **Role**

The current STP port role of the port. The port role can be one of the following values: AlternatePort BackupPort RootPort DesignatedPort Disabled.

- **State**

The current STP port state of the port. The port state can be one of the following values: Discarding Learning Forwarding.

Aggregation Configuration

Group Configuration:

Trunking Group	Enable LACP Dynamic Trunking	Port Members
1	<input type="checkbox"/>	Select Some Options
2	<input type="checkbox"/>	Select Some Options
3	<input type="checkbox"/>	Select Some Options
4	<input type="checkbox"/>	Select Some Options
5	<input type="checkbox"/>	Select Some Options
6	<input type="checkbox"/>	Select Some Options

6.16 Aggregation

Port trunking is the combination of several ports or network cables to expand the connection speed beyond the limits of any one single port or network cable. Link Aggregation Control Protocol (LACP), which is a protocol running on layer 2, provides a standardized means in accordance with IEEE 802.3ad to bundle several physical ports together to form a single logical channel. All the ports within the logical channel or so-called logical aggregator work at the same connection speed and LACP operation requires full-duplex mode.

6.16.1. Aggregation Configuration

- **Trunking Group :**
There are 6 trunk groups to be selected.
- **Enable LACP Dynamic Trunking:**
Enable LACP with the dedicated trunking group.
- **Port member:** This column field allows the user to choose the total number of active port up to four. With **LACP**, e.g. you assign four ports to be the members of a trunk group whose work ports column field is set as two; the exceed ports

are standby/redundant ports and can be aggregated if working ports fail.

LACP Group Status

Trunking Group	LACP	System ID	Port Members
----------------	------	-----------	--------------

6.16.2 LACP Port Status

You can check the setting of Port aggregation in Status.

- **Trunking Group**

Number of trunking group

- **LACP**

'Yes' means that LACP is enabled and the port link is up. 'No' means that LACP is not enabled or that the port link is down. 'Backup' means that the port could not join the aggregation group but will join if other port leaves. Meanwhile it's LACP status is disabled.

- **System ID**

The ID of each Trunking group

- **Port Members**

Each switch port is listed for each group ID. Select a radio button to include a port in an aggregation, or clear the radio button to remove the port from the aggregation. By default, no ports belong to any aggregation group. Only full duplex ports can join an aggregation and ports must be in the same speed in each group.

PTP Configuration

Enable on	<input type="text" value="select ports to enable PTP"/>
Domain:	<input type="text" value="0"/>
Priority 1:	<input type="text" value="255"/>
Priority 2:	<input type="text" value="255"/>
Announce Interval:	<input type="text" value="1"/>
Announce Interval Timeout:	<input type="text" value="2"/>
Sync Interval:	<input type="text" value="1"/>
Delay Request Interval:	<input type="text" value="1"/>

6.20 Maintenance

6.20.1 Save Configuration

Save setting of switch

System Config Save

Save

6.20.2 Config backup/restore

■ Settings Backup

You can download the backup configuration of the switch.

■ Settings Restore

You can copy the backup configuration of the switch to the startup configuration on this page. The new startup configuration is not available immediately, which means that restart the switch is necessary.

■ Reset to default

You can reset the configuration of the switch on this page. Only the IP configuration is retained. The new configuration is available immediately, which means that no

Config Backup/Restore

Settings Backup

Click button to download current settings

Download settings

Settings Restore

Select the file previously backup to restore

Select File

Reset to default

Click button to reset to default settings

Restore to default

Keep IP & Account



res

start is necessary.

6.20.3 Restart device

Reboot the switch with selected firmware.

Maintaince Reboot

Active Firmware

- Firmware 1
- Firmware 2

Restart Device

6.20.4 Firmware Upgrade

Update the switch with the firmware file which on your desktop.

Firmware Upgrade

Select the firmwire file to upload

Select File

6.20.5 Diagnostics

■ PING

Address: Set the IP address which you want to ping

Count: Set the times of Ping

Packet Size: set the size of Ping packet.

Plug **ARP Table**

Address

Count

Packet Size

```

PING 192.168.9.1 (192.168.9.1): 64 data bytes
72 bytes from 192.168.9.1: seq=0 ttl=255 time=8.048 ms
72 bytes from 192.168.9.1: seq=1 ttl=255 time=0.429 ms
72 bytes from 192.168.9.1: seq=2 ttl=255 time=0.420 ms
72 bytes from 192.168.9.1: seq=3 ttl=255 time=0.417 ms
--- 192.168.9.1 ping statistics ---
4 packets transmitted, 4 packets received, 0% packet loss
round-trip min/avg/max = 0.417/2.328/8.048 ms

```

■ ARP Table

You can find the MAC address of each IP you have ping via this switch in here.

Plug **ARP Table**

ARP Table

00:1f:c6:3d:7e:be	192.168.9.47
00:50:7f:5a:3e:b8	192.168.9.1

■ DDM

You can monitor the status of SFP module via DDM function.

Note: Only the SFP module which support DDM spe. can offer the DDM information via switch.

Diagnostics

Ping ARP Table **DDM**

SFP Digital Diagnostic Monitor

Hide Thresholds:

Event Setup

Port 9 Link Down

Type	Temperature	Vcc	Bias	TX Power	RX Power
High Alarm	0.0 °C	0.0 V	0.0 mA	-∞ dBm	-∞ dBm
High Warning	0.0 °C	0.0 V	0.0 mA	-∞ dBm	-∞ dBm
Current Value	0.0 °C	0.0 V	0.0 mA	-∞ dBm	-∞ dBm
Low Warning	0.0 °C	0.0 V	0.0 mA	-∞ dBm	-∞ dBm
Low Alarm	0.0 °C	0.0 V	0.0 mA	-∞ dBm	-∞ dBm

Hide Thresholds: hide the thresholds information and only display the status information

SFP Digital Diagnostic Monitor

Hide Thresholds:

Event Setup

Port 9 Link Down

Type	Temperature	Vcc	Bias	TX Power	RX Power
Current Value	0.0 °C	0.0 V	0.0 mA	-∞ dBm	-∞ dBm

Port 10 Link Down

Type	Temperature	Vcc	Bias	TX Power	RX Power
Current Value	0.0 °C	0.0 V	0.0 mA	-∞ dBm	-∞ dBm

Event setup: will be redirected to DDM event, please reference to page47

Events

Env Monitor Event

DDM Event

SFP Digital Diagnostic Monitor Event

Enable DDM Events:

Apply

Appendix —Command Line mode

Except the web access mode, the Lantech switch also support Telnet access and console access mode, to compare the web access mode, both the Telnet and console only support command line user interface, all these commands are shown as below:

1. Access via console port

When the connection between Switch and PC is ready, turn on the PC and run a terminal emulation program or **Hyper Terminal** and configure its **communication parameters** to match the following default characteristics of the console port:

Baud Rate:115200 bps

Data Bits: 8

Parity: none

Stop Bit: 1

Flow control: None

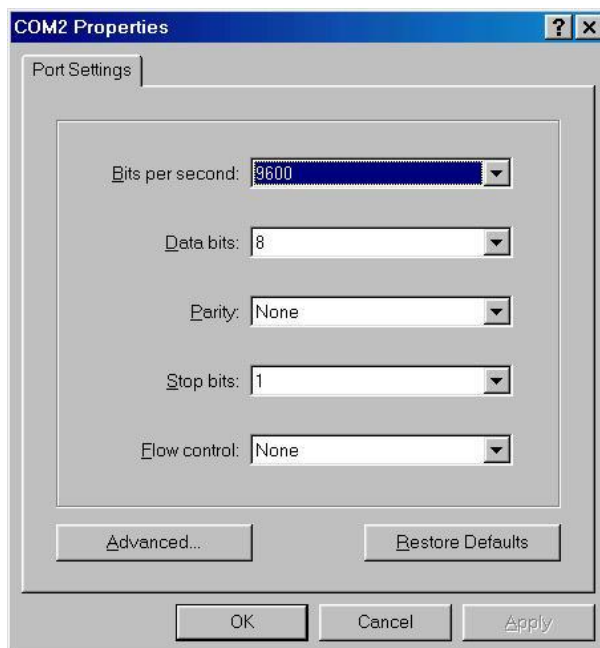

The settings of communication parameters

Having finished the parameter settings, click '**OK**'. When the blank screen shows up, press Enter key to have the login prompt appears. First you need to key in '**admin**' (default value) for both User name and Password (use **Enter** key to switch), then press

Enter and the Main Menu of console management appears. Please see below figure for login screen.

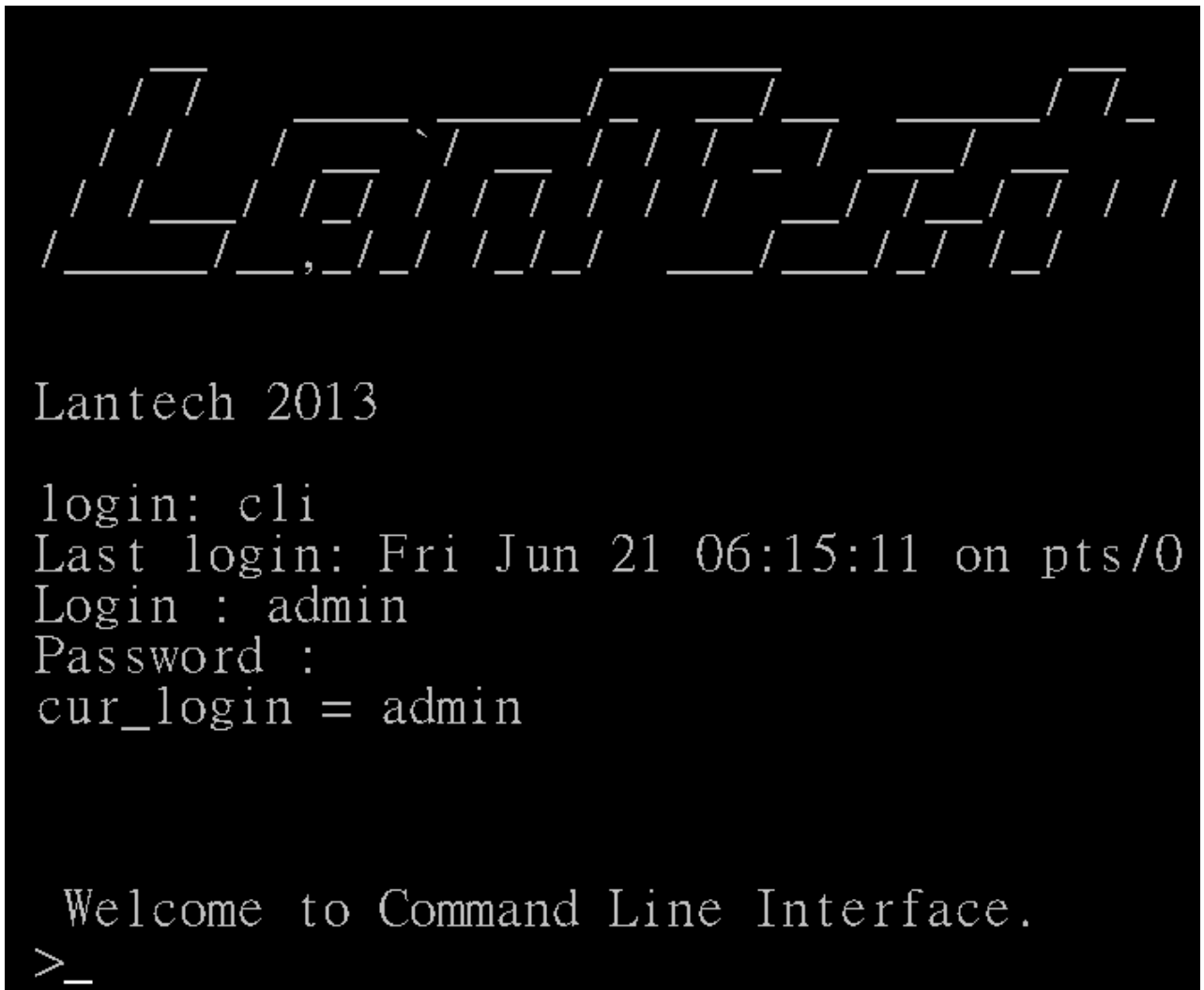

```

Lantech 2013

login: cli
Last login: Fri Jun 21 06:15:11 on pts/0
Login : admin
Password :
cur_login = admin

Welcome to Command Line Interface.
>_
```

Notice: if you forgot the password, you can access the switch via console port and input lantech /lantech to restore the password to default.

2. Access via Telnet

Use Telnet utility to access switch IP and make sure the socket was set as 23, all the commands under Telnet mode were the same as the Console mode.

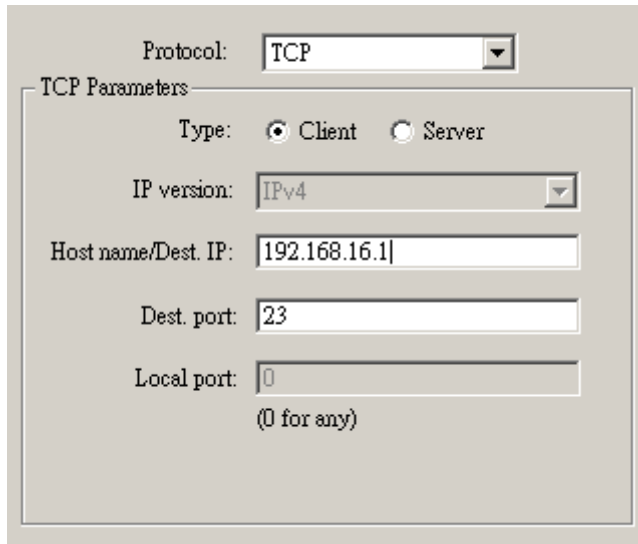

The image shows a configuration window for a Telnet client. At the top, there is a 'Protocol' dropdown menu set to 'TCP'. Below this is a section titled 'TCP Parameters' which contains several fields: 'Type' with radio buttons for 'Client' (selected) and 'Server'; 'IP version' dropdown set to 'IPv4'; 'Host name/Dest. IP' text box containing '192.168.16.1'; 'Dest. port' text box containing '23'; and 'Local port' text box containing '0'. Below the 'Local port' field, there is a note '(0 for any)'.

3. Commands

3.1 System

Command: system

Parameter: N/A

Description: Enter the system mode

Example:

```

>system
Available Commands:
System Configuration
System Contact [<contact>]
System Name [<name>]
System Location [<location>]
System Description [<description>]
System DHCPClient [enable]
System DHCPServer [enable]
System DHCPStatus
System NetStatus
System NetSettingIPv4
System NetSettingIPv6
System Reboot
System RestoreDefault
System Log
System Save
System Ping [<IpAddr>]
System Arp
System Memory
System ConfigAccess [enable]
System Upgrade [URL]
SYSTEM>_

```

3.1.1 Command: system> configuration

Parameter: N/A

Description: show the information of switch

Example:

```

SYSTEM>configuration
SYSTEM>
SystemName : IES-5408DSFP
SystemDescription : 4 1000 SFP +
SystemLocation : 13
SystemContact :
SystemTimeZoneOffset : 0
OID : 1.3.6.1.4.1.37072.302.2.3
MacAddr : 00:11:22:33:44:81
SystemDate : Fri Jun 21 2013 15:
SystemUptime : 77141
SoftwarekernelVersion : 39c48cd6
SoftwareVersion : V3.27

```

3.1.2 Command: system > Contact

Parameter: N/A

Description: display or fix the contact information

Example: if I want to change the contact windows to jacky@lantechcom.tw

```
SYSTEM>contact jacky@lantechcom.tw
SYSTEM>
SystemContact : jacky@lantechcom.tw
```

3.1.3 Command: system > name

Parameter: N/A

Description: display or fix the system name

Example:

```
SYSTEM>name
SYSTEM>
SystemName : IES-5408DSFP
SYSTEM>name IGS-5400-2P
SYSTEM>
SystemName : IGS-5400-2P
```

3.1.4 Command: system > location

Parameter: N/A

Description: display or fix the location

Example:

```
SYSTEM>location
SYSTEM>
SystemLocation : 13
SYSTEM>location Taiwan
SYSTEM>
SystemLocation : Taiwan
```

3.1.5 Command: system > description

Parameter: N/A

Description: display or fix the system description

Example:

```
SYSTEM>
SystemDescription : switch
SYSTEM>description industrial
SYSTEM>
SystemDescription : industrial
```

3.1.6 Command: system > DHCPclient

Parameter: enable/disable

Description: enable or disable DHCP client

Example:

```
SYSTEM>dhcpclient enable
SYSTEM>
DHCP Client enable: 0
SYSTEM>dhcpclient disable
SYSTEM>
DHCP Client enable: 1
```

3.1.7 Command: system > DHCP server

Parameter: [enable|disable]→ enable or disable DHCP server

[<range_low>]/[<range_high>]→ set the IP range

[<netmask>]→ set submask

[<gateway>]→ set gateway

[<dns>]→ set DNS server

[<lease_time>]→ set the lease time of released IP

Example:

```
SYSTEM>DHCPserver
SYSTEM>
DHCP Server enable: true
DHCP Server range_low: 192.168.9.100
DHCP Server range_high: 192.168.9.200
DHCP Server netmask: 255.255.255.0
DHCP Server gateway: 192.168.16.254
DHCP Server dns: 8.8.8.8
DHCP Server lease_time: 86400
```

3.1.8 Command system > DHCPstatus

Parameter: N/A

Description: show the information of DHCP client

Example:

```

SYSTEM>DHCPstatus
SYSTEM>
MacAddress          IpAddress
-----
00:1f:c6:3d:7e:25  192.168.9.101

```

3.1.9 Command: system > netstatus

Parameter: N/A

Description: show the status about IP address

Example:

```

SYSTEM>netstatus
SYSTEM>
IpAddr  : 192.168.16.1
Netmask : 255.255.255.0
GatewayIp :
DnsIp   : 168.95.1.1

```

3.1.10 Command: system > netsettingIPv4

Parameter: [<IpAddr>]→ set IP address

[<netmask>]→ set netmask

[<gatewayip>]→ set gateway

[<dnsip>]→ set DNS server

Description: set the IP detail of switch

Example:

```

SYSTEM>netsettingIPv4
SYSTEM>
IpAddr  : 192.168.16.1
Netmask : 255.255.255.0
GatewayIp : 192.168.9.1
DnsIp   : 168.95.1.1

```

3.1.11 Command: system > netsettingIPv6

Parameter: N/A

Description: set the IP address of IPv6

Example:

```

SYSTEM>netsettingIPv6
SYSTEM>
IpAddrv6 : 2001:0db8:0:f101::3

```

3.1.12 Command: system > reboot

Parameter: N/A

Description: reboot the switch

Example:

```
SYSTEM>reboot
SYSTEM>System Reboot after 1 sec

Broadcast message from root (Fri Jun 21 17
The system is going down for reboot NOW!
```

3.1.13 Command: system > restoredefault

Parameter: keep_none → restore all setting

keep_all → restore all but keep original IP address and account

keep_ip → restore all but keep original IP address

keep_account → restore all but keep original account

Description: restore the setting of switch to factory default

Example:

```
SYSTEM>restoredefault ?
Invalid parameter:?
Syntax: System RestoreDefault [keep_none | keep_all | keep_ip | keep_account]
```

3.1.14 Command: system > log

Parameter: N/A

Description: display the event log

Example:

```
Fri, 21 Jun 2013 03:40:27 GMT linkchg
Fri, 21 Jun 2013 05:37:26 GMT linkchg
Fri, 21 Jun 2013 05:37:40 GMT boot
Fri, 21 Jun 2013 06:04:23 GMT auth
Fri, 21 Jun 2013 06:15:20 GMT auth
```

3.1.15 Command: system > save

Parameter: N/A

Description: save the fixed setting

Example:

```
SYSTEM>save
SYSTEM>
System save success!!
```

3.1.16 Command: system > ping

Parameter: N/A

Description: ping the IP address

Example:

```
SYSTEM>ping 192.168.16.1
SYSTEM>host 192.168.16.1 is alive
```

3.1.17 Command: system > arp

Parameter: N/A

Description: resolve the IP address to MAC address

Example:

```
SYSTEM>arp
SYSTEM>
IpAddress                MacAddress
-----                -
                192.168.16.66                00:1f:c6:3d:7e:25
```

3.1.18 Command: system > memory

Parameter: N/A

Description: display the status of used switch memory

Example:

```
SYSTEM>memory
SYSTEM>
Type                Size(kb)
-----                -
MemTotal                239540
MemFree                173664
```

3.1.19 Command: system > configaccess

Parameter: [export|import] → export or import the setting of switch
[URL] → set the destination which save/load the setting file, support
both the TFTP and FTP protocol.

Description: export or import the setting of switch

Example:

```
SYSTEM>configaccess export ftp://192.168.16.66
```

3.1.20 Command: system > upgrade

Parameter: [URL] → set the source of firmware file, support TFTP and FTP and HTTP protocol.

Description: update switch firmware

Example:

```
SYSTEM>upgrade tftp:192.168.16.1  
Please wait for upgrade
```

3.2 LLDP

Command: LLDP

Parameter: N/A

Description: Enter the LLDP mode

Example:

```
>lldp  
Available Commands:  
LLDP Configuration [<port_list>]  
LLDP Enabled [enable|disable]  
LLDP Mode [<port_list>] [enabledRx  
LLDP Interval [<interval>]  
LLDP Timetolive [<tvl>]  
LLDP Info [<port_list>]  
LLDP Statistics [clear]  
LLDP>_
```

3.2.1 Command: LLDP > configuration

Parameter: N/A

Description: display the LLDP information

Example:

```

LLDP>configuration
LLDP>
Interval: 10
Port      Mode
-----
 1      enabledRxTx
 2      enabledRxTx
 3      enabledRxTx
 4      enabledRxTx
 5      enabledRxTx
 6      enabledRxTx
 7      enabledRxTx
 8      enabledRxTx
 9      enabledRxTx
10      enabledRxTx
11      enabledRxTx
12      enabledRxTx

```

3.2.2 Command: LLDP > enabled

Parameter: N/A

Description: enable LLDP protocol

Example:

```

LLDP>enabled
LLDP>
Enabled: true

```

3.2.3 Command: LLDP > mode

Parameter: [<port_list>]→display LLDP information of the dedicated port

[enabledRxTx]→ enable Tx and Rx of LLDP function with dedicated port

[enabledTxOnly]→ enable Tx only of LLDP function with dedicated port

[enabledRxOnly]→ enable Rx only of LLDP function with dedicated port

[disabled]→ disable LLDP function with dedicated

Description: enable LLDP function of each port

Example:

```

LLDP>mode
LLDP>
Port      Mode
-----
1         enabledRxTx
2         enabledRxTx
3         enabledRxTx
4         enabledRxTx
5         enabledRxTx
6         enabledRxTx
7         enabledRxTx

```

3.2.4 Command: LLDP > interval

Parameter: N/A

Description: set the interval time of LLDP

Example:

```

LLDP>interval 10
LLDP>
Interval: 10

```

3.2.5 Command: LLDP > timetolive

Parameter: N/A

Description: display the alive time of LLDP information.

Example:

```

LLDP>timetolive
LLDP>
Time to live : 15

```

3.2.6 Command: LLDP > info

Parameter: N/A

Description: display the LLDP information of neighbor port

Example:

```

LLDP>info
LLDP>
Localport          ChassisID          PortID  PortDescription  SystemName
-----

```

3.2.7 Command: LLDP > statistics

Parameter: N/A

Description: display the detail information of LLDP settings

Example:

```

LLDP>statistics
LLDP>
Total LLDP traffic statistics
Total entries added : 0
Total entries deleted : 0
Total entries aged : 0
Total frames out : 6127
Total frames in : 0
Total frames received in error : 0
Total frames discarded : 0
Total TLVs discarded : 0
Total TLVs unrecognized : 0
Localport          FramesIn          FramesOut
-----
          1          0          55
          2          0          55
          3          0          55
          4          0          55

```

3.3 Port

Command: port

Parameter: N/A

Description: Enter the port mode

Example:

```

>port
Available Commands:
Port Configuration [<port_list>]
Port Status [<port_list>]
Port Enabled [<port_list>] [enable|disable]
Port Description [<port_list>] [string]
Port Speed [<port_list>] [10hdx|10fdx|100hdx]
Port FlowControl [<port_list>] [enable|disable]
Port IngressRate [<port_list>] [<rate> kbps]
Port EgressRate [<port_list>] [<rate> kbps]
Port Statistics [clear]

```

3.3.1 Command: port > configuration

Parameter: N/A

Description: display the setting of each port

Example:

```

PORT>configuration
PORT>

```

Port	enabled	Description	Speed	Conf	Flow Control	Con
1	true	Port 1	auto			tru
2	true	Port 2	auto			tru
3	true	Port 3	auto			tru
4	true	Port 4	auto			tru
5	true	Port 5	auto			tru
6	true	Port 6	auto			tru
7	true	Port 7	auto			tru
8	true	Port 8	auto			tru

3.3.2 Command: port > status

Parameter: N/A

Description: display the connection status of each port

Example:

```

PORT>status
PORT>
Port      Group ID      Type      Link      State      Speed
-----
1         -1            100TX    down      enable     N/A
2         -1            100TX    down      enable     N/A
3         -1            100TX    down      enable     N/A
4         -1            100TX    up        enable     100
5         -1            100TX    down      enable     N/A
6         -1            100TX    down      enable     N/A
7         -1            100TX    down      enable     N/A
8         -1            100TX    down      enable     N/A
9         -1            DSFP     down      enable     N/A

```

3.3.3 Command: port > enabled

Parameter: [<port_list>]→ choose which port you want to enable or disable
 [enable|disable]→ enable/disable

Description: enable or disable switch port

Example:

```

PORT>enable
PORT>
Port      Enabled
-----
1         true
2         true
3         true
4         true
5         true
6         true
7         true

```

3.3.4 Command: port > description

Parameter: N/A

Description: display the description of each port

Example:

```
PORT>description
PORT>
Port      Description
-----
1         Port 1
2         Port 2
3         Port 3
4         Port 4
5         Port 5
```

3.3.5 Command: port > speed

Parameter: N/A

Description: display the speed of each port

Example:

```
PORT>speed
PORT>
Port      Speed Conf
-----
1         auto
2         auto
3         auto
4         auto
5         auto
```

3.3.6 Command: port > flowcontrol

Parameter: [<port_list>]→ choose which port you want to enable or disable
[enable|disable]→ enable/disable

Description: enable or disable flow control function of each port

Example:

```

PORT>flowcontrol
PORT>
Port      FlowControl Conf
-----
1         true
2         true
3         true
4         true
5         true
6         true
7         true

```

3.3.7 Command: port > Ingressrate

Parameter: [<port_list>]→ choose which port you want to set the ingress rate

[<rate> kbps]→set the ingress rate of these packet as below

- ◆ broadcast
- ◆ multicast
- ◆ unicast
- ◆ broad_uni
- ◆ broad_multi
- ◆ multi_uni
- ◆ uni_broad_multi

Description: set the ingress rate of the dedicated port with specified packet

Example:

```

PORT>ingressrate
PORT>
Port      Ingress Rate      Ingress Type
-----
1         0
2         0
3         0
4         0

```

3.3.8 Command: port > egressrate

Parameter: [<port_list>] → choose which port you want to set the ingress rate

[<rate> kbps] → set the ingress rate

Description: set the egress rate of the dedicated port

Example:

```
PORT>egress
PORT>
Port      Egress Rate
-----
1         0
2         0
3         0
4         0
```

3.3.9 Command: port > statistics

Parameter: N/A

Description: display the detail information of port statistics

Example:

```
PORT>statistics
PORT>
ports :
Txgoodbyte :
Txgoodpkts :
Txmcpkts :
Txbrdcpkts :
Txerr :
Txucpkts :
Txmultiplepkts :
Txdeferredpkts :
Rxgoodbyte :
Rxbadbyte :
Rxgoodpkts :
Rxbadpkts :
Rxbrdcpkts :
Rxmcpkts :
Rxmacerror :
Rxbadfc :
Rxucpkts :
Rxunrecogentr :
Rxgoodfc :
64byte_ :
```