

Neosys Technology Inc.

Nuvo-2822

User Manual

Revision 1.0

Table of Contents

Table of Contents	2
Legal Information	4
Contact Information	5
Declaration of Conformity	5
Copyright Notice	6
Safety Precautions	7
Service and Maintenance	8
ESD Precautions	8
About This Manual	9
1 Introduction	
1.1 Product Specifications	11
1.1.1 Nuvo-2822 Specifications	11
1.2 Nuvo-2822 Dimensions	13
1.2.1 Nuvo-2822 I/O Panel View	13
1.2.2 Nuvo-2822 Side View	14
1.2.3 Nuvo-2822 Bottom View	15
2 Overview	
2.1 Nuvo-2822 Packing List	16
2.2 Nuvo-2822 Series I/O Panel	17
2.2.1 Power Button	19
2.2.2 Reset Button	20
2.2.3 USB3.2 Gen2 Ports	21
2.2.4 USB2.0 Ports	22
2.2.5 HDMI Port	23
2.2.6 DisplayPort	24
2.2.7 Digital Input/ Output	25
2.2.8 Clear CMOS Button	27
2.2.9 Gigabit Ethernet Ports	28
2.2.10 Status LED Indicators	29
2.2.11 COM2/ 3/ 4 Port	30
2.2.12 COM1 Port	31
2.2.13 2-Pin Terminal Block for DC Input	32
2.2.14 Reserved Panel for On/ Off Ctrl & Status LED Connector (Optional)	33
2.3 Internal I/O Functions	34
2.3.1 SODIMM DRAM Slot	34
2.3.2 M.2 2280 (M-key) Slot (SATA Signal Only) for SSD	35
2.3.3 On/ Off Ctrl & Status Output	36
3 System Installation	
3.1 Disassembling the System	39
3.2 Installing Internal Components	43
3.2.1 DDR5 SO-DIMM Installation	43
3.2.2 M.2 2280 SSD Installation	45
3.2.3 On/ Off Control & Status LED Cable Installation (Optional)	47
3.2.4 Fan Installation (Optional)	51
3.3 Installing the System Enclosure	53
3.4 Wall-mount Bracket Installation	55
3.5 Powering On the System	56
3.5.1 Powering On Using the Power Button	56
3.5.2 Powering On Using Wake-on-LAN	57
3.5.3 Configure your Windows system	59

4 System Configuration

4.1	BIOS Settings	60
4.1.1	COM Port Configuration.....	61
4.1.2	COM Port High Speed Mode	62
4.1.3	Init Delay Before PCIe Reset	63
4.1.4	Power On After Power Failure Option	64
4.1.5	Power & Performance.....	65
4.1.6	Power Saving Mode.....	66
4.1.7	Wake on LAN Option	67
4.1.8	Boot Menu	68
4.1.9	Position New Boot Device.....	70
4.1.10	Watchdog Timer for Booting.....	71

5 OS Support and Driver Installation

5.1	Operating System Compatibility	72
5.2	Driver Installation	73
5.3	Drivers Installation for Watchdog Timer Control	73

Appendix A Using WDT & DIO

WDT and DIO Library Installation	75
WDT Function Reference	77
InitWDT	77
SetWDT	77
StartWDT	78
ResetWDT	78
StopWDT	78
DIO Functions.....	79
InitDIO.....	79
DIReadLine	79
DIReadPort	79
DOWriteLine.....	80
DOWritePort.....	80

Legal Information

All Neosys Technology Inc. products shall be subject to the latest Standard Warranty Policy

Neosys Technology Inc. may modify, update or upgrade the software, firmware or any accompanying user documentation without any prior notice. Neosys Technology Inc. will provide access to these new software, firmware or documentation releases from download sections of our website or through our service partners.

Before installing any software, applications or components provided by a third party, customer should ensure that they are compatible and interoperable with Neosys Technology Inc. product by checking in advance with Neosys Technology Inc.. Customer is solely responsible for ensuring the compatibility and interoperability of the third party's products. Customer is further solely responsible for ensuring its systems, software, and data are adequately backed up as a precaution against possible failures, alternation, or loss.

For questions in regards to hardware/ software compatibility, customers should contact Neosys Technology Inc. sales representative or technical support.

To the extent permitted by applicable laws, Neosys Technology Inc. shall NOT be responsible for any interoperability or compatibility issues that may arise when (1) products, software, or options not certified and supported; (2) configurations not certified and supported are used; (3) parts intended for one system is installed in another system of different make or model.

Contact Information

Headquarters
(Taipei, Taiwan)

Neosys Technology Inc.
15F, No.868-3, Zhongzheng Rd., Zhonghe Dist., New Taipei City, 23586, Taiwan
Tel: +886-2-2223-6182 Fax: +886-2-2223-6183 [Email](#), [Website](#)

Americas
(Illinois, USA)

Neosys Technology America Inc.
3384 Commercial Avenue, Northbrook, IL 60062, USA
Tel: +1-847-656-3298 [Email](#), [Website](#)

China

Neosys Technology (China) Ltd.
Room 612, Building 32, Guiping Road 680, Shanghai
Tel: +86-2161155366 [Email](#), [Website](#)

Declaration of Conformity

FCC

This equipment has been tested and found to comply with the limits for a Class A digital device, pursuant to part 15 of the FCC Rules. These limits are designed to provide reasonable protection against harmful interference when the equipment is operated in a commercial environment. This equipment generates, uses, and can radiate radio frequency energy and, if not installed and used in accordance with the instruction manual, may cause harmful interference to radio communications. Operation of this equipment in a residential area is likely to cause harmful interference in which case the user will be required to correct the interference at own expense.

CE

The product(s) described in this manual complies with all applicable European Union (CE) directives if it has a CE marking. For computer systems to remain CE compliant, only CE-compliant parts may be used. Maintaining CE compliance also requires proper cable and cabling techniques.

Copyright Notice

All rights reserved. This publication may not be reproduced, transmitted, transcribed, stored in a retrieval system, or translated into any language or computer language, in any form or by any means, electronic, mechanical, magnetic, optical, chemical, manual or otherwise, without the prior written consent of Neosys Technology, Inc.

Disclaimer

This manual is intended to be used as an informative guide only and is subject to change without prior notice. It does not represent commitment from Neosys Technology Inc. Neosys Technology Inc. shall not be liable for any direct, indirect, special, incidental, or consequential damages arising from the use of the product or documentation, nor for any infringement on third party rights.

Patents and Trademarks

Neosys, the Neosys logo, Expansion Cassette, MezIO™ are registered patents and trademarks of Neosys Technology, Inc.

Windows is a registered trademark of Microsoft Corporation.

Intel®, Core™ are registered trademarks of Intel Corporation

NVIDIA® is a registered trademark of NVIDIA Corporation

All other names, brands, products or services are trademarks or registered trademarks of their respective owners.

Safety Precautions

- Read these instructions carefully before you install, operate, or transport the system.
- Install the system or DIN rail associated with, at a sturdy location
- Install the power socket outlet near the system where it is easily accessible
- Secure each system module(s) using its retaining screws
- Place power cords and other connection cables away from foot traffic. Do not place items over power cords and make sure they do not rest against data cables
- Shutdown, disconnect all cables from the system and ground yourself before touching internal modules
- Ensure that the correct power range is being used before powering the device
- Should a module fail, arrange for a replacement as soon as possible to minimize down-time
- If the system is not going to be used for a long time, disconnect it from mains (power socket) to avoid transient over-voltage

Service and Maintenance

- ONLY qualified personnel should service the system
- Shutdown the system, disconnect the power cord and all other connections before servicing the system
- When replacing/ installing additional components (expansion card, memory module, etc.), insert them as gently as possible while assuring proper connector engagement

ESD Precautions

- Handle add-on module, motherboard by their retention screws or the module's frame/ heat sink. Avoid touching the PCB circuit board or add-on module connector pins
- Use a grounded wrist strap and an anti-static work pad to discharge static electricity when installing or maintaining the system
- Avoid dust, debris, carpets, plastic, vinyl and styrofoam in your work area.
- Do not remove any module or component from its anti-static bag before installation

About This Manual

This manual introduces Neosys Nuvo-2822 series featuring Intel® Alder Lake N CPU with two PCIe and PCI slots expandability.

The guide also demonstrates the system's installation procedures.

Revision History

Version	Date	Description
1.0	Sep. 2024	Initial release

1 Introduction

Nuvo-2822 is a compact expansion box PC powered by an Intel Alder Lake N CPU featuring two PCIe and two PCI slots. The expansion slots are designed to support various frame grabbers, motion control cards, COM port expansion cards, and data acquisition cards.



With up to five times the performance boost compared to our previous Nuvo-2400 series, the new Nuvo-2822 can efficiently process vast amounts of data acquired from extensive I/O interfaces in real time. It features two Ethernet ports with I210-IT controllers, and two USB 3.2 Gen 2 ports with screw lock mechanisms to connect and secure industrial cameras for machine vision applications. Furthermore, the Nuvo-2822 supports 8-channel isolated DIO and four COM ports to communicate with and control various industrial sensors, indicators, motors, and actuators.

The system also features a unique “Super Power Saving Mode” to minimize energy consumption when the system is in standby (S4/S5) mode, significantly reducing electricity usage without taxing performance. Thanks to its compact dimensions, it can be deployed in restricted spaces or small cabinets. With support for versatile PCIe and PCI expansion cards, it is ideal for industrial control and machine automation applications.

1.1 Product Specifications

1.1.1 Nuvo-2822 Specifications

System Core	
Processor	Intel® Alder Lake N97 (4C/ 4T, 2.0/ 3.6GHz, 12W TDP)
Graphics	Integrated Intel® UHD Graphics with 24EUs
Memory	Up to 16 GB DDR5 4800 SDRAM (one SODIMM slot)
TPM	Supports dTPM 2.0
I/O Interface	
Ethernet	2x Gigabit Ethernet port by Intel® I210-IT (1x WOL)
USB	2x USB 3.2 Gen2 ports with screw-lock 2x USB 2.0 ports with screw-lock
Video port	1x DP++, supporting 4096 x 2169 resolution 1x HDMI 1.4b, supporting 3840 x 2160 @ 30 Hz
Serial Port	1x software-programmable RS-232/ 422/ 485 ports (COM1) 3x 3-wire RS-232 ports (COM3/ COM4/ COM5)
Isolate DIO	4-CH isolated DI and 4-CH isolated DO
Storage Interface	
M.2 M key	1x M.2 2280 M key expansion slot (SATA signal only)
Expansion Bus	
PCI Express	1x PCIe x4 slot@Gen3, 4-lanes 1x PCIe x4 slot@Gen3, 1-lanes
PCI	2x 33MHz/ 32-bit 5V
Power Supply	
DC Input	1x 2-pin pluggable terminal block for 12V to 24V DC input
Remote ctrl & LED output (optional)	1x 10-pin (2x5) wafer connector for remote on/ ff control and status LED output
Mechanical	
Dimension	164.6 mm (W) x 214 mm (D) x 135.6 mm (H)
Weight	2.3 Kg
Mounting	Wall-mounting (optional)
Environmental	
Operating temperature	With fan kit -10°C to 70°C [1][2] Without fan kit -10°C to 60°C [1]

Storage temperature	-40°C to 85°C
Humidity	10% to 90%, non-condensing
Vibration	MIL-STD-810H, Method 514.8, Category 4
Shock	MIL-STD-810H, Method 516.8, Procedure I
EMC	CE/ FCC Class A, according to EN 55032 & EN 55035

[1] For sub-zero and over 60°C operating temperatures, a wide temperature Solid State Disk (SSD) is required.

[2] The optional fan kit is recommended for operating at ambient temperatures higher than 60°C.

1.2 Nuvo-2822 Dimensions

 NOTE

All measurements are in millimeters (mm).

1.2.1 Nuvo-2822 I/O Panel View

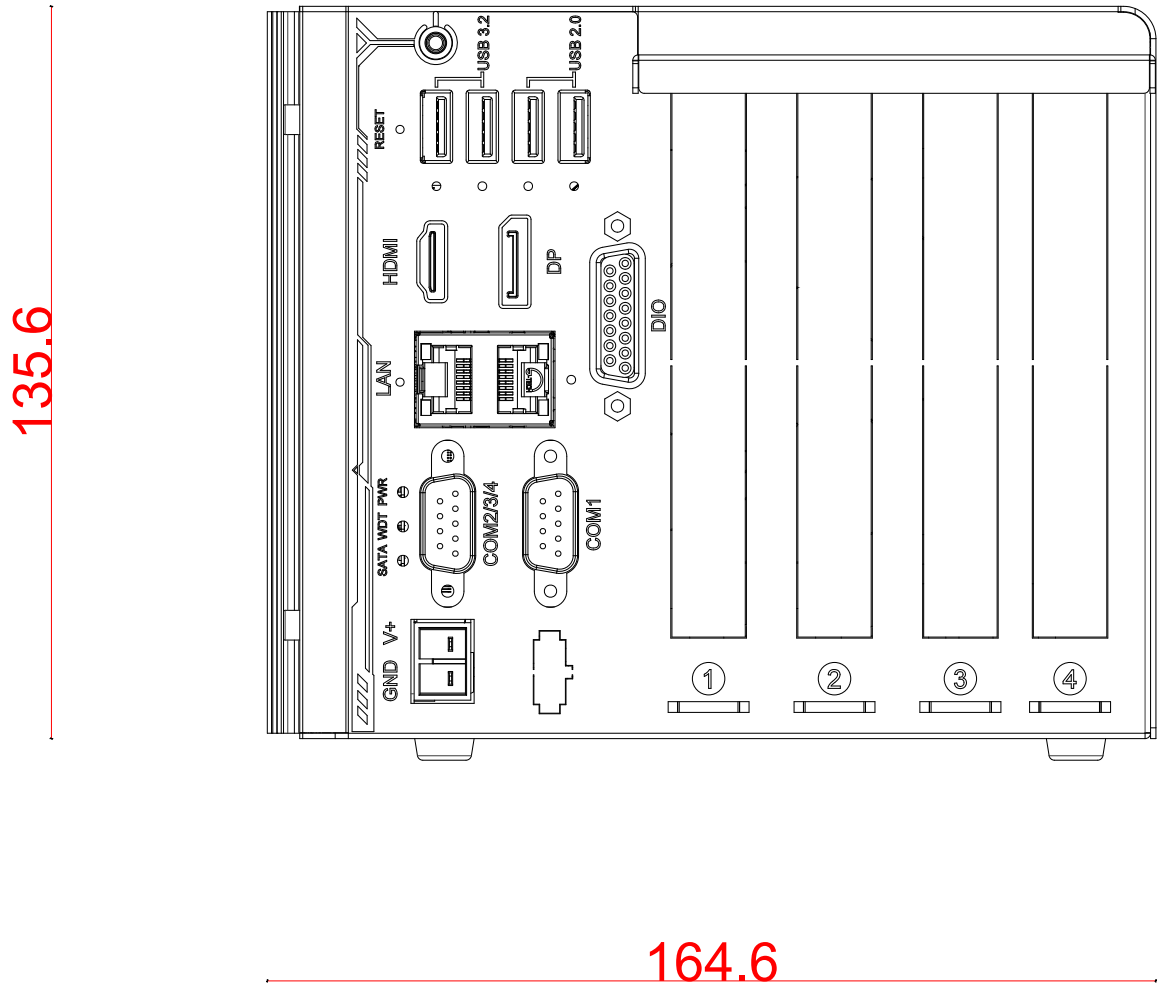

1.2.2 Nuvo-2822 Side View

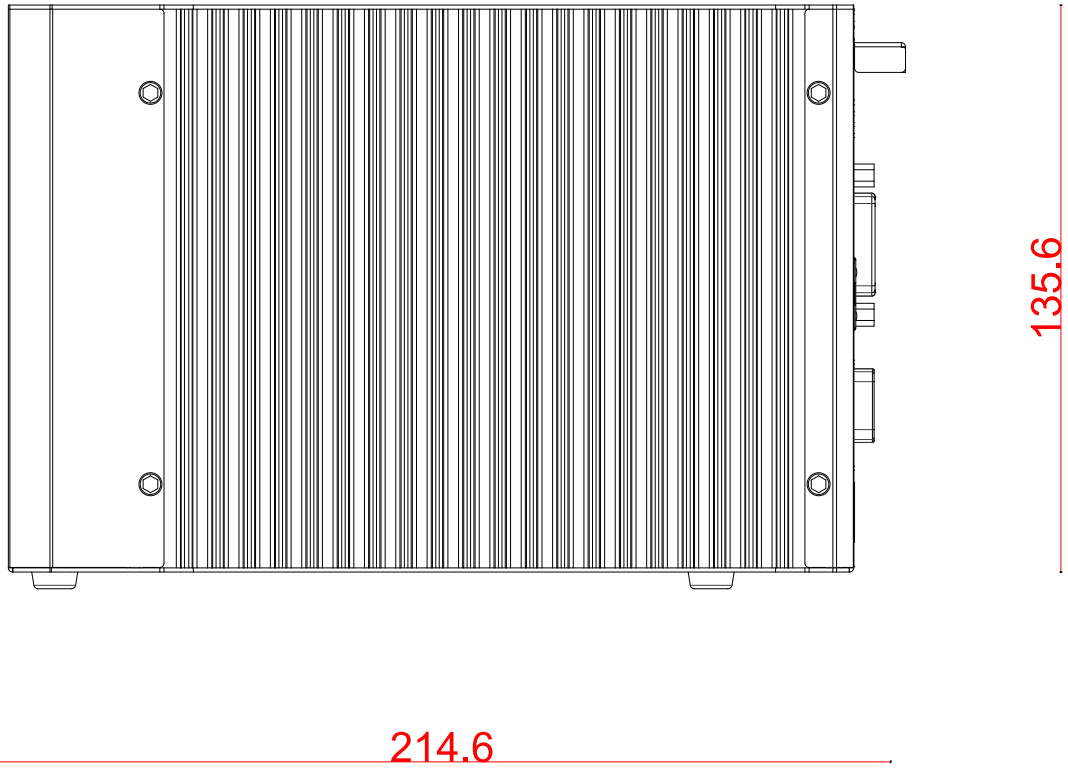

1.2.3 Nuvo-2822 Bottom View

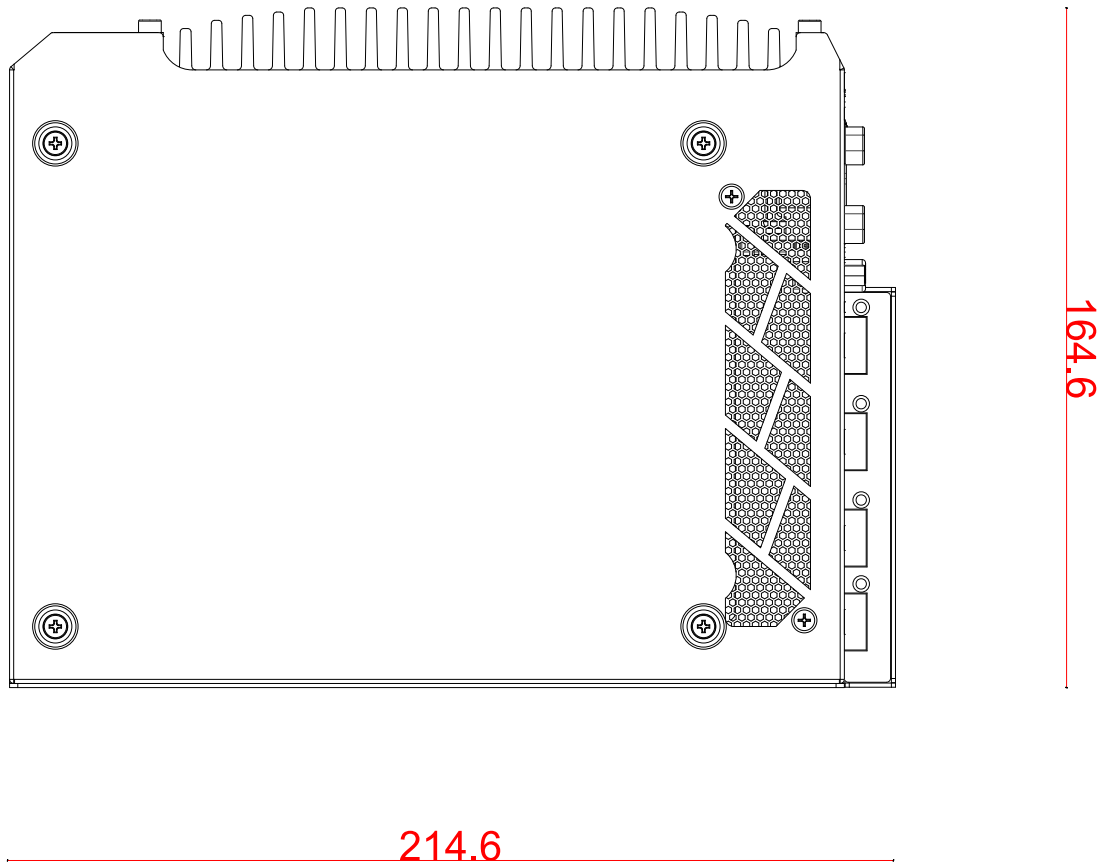

2 Overview

Upon receiving and unpacking your Nuvo-2822 system, please check immediately if the package contains all the items listed in the following table. If any item(s) are missing or damaged, please contact your local dealer or Neosys Technology.

2.1 Nuvo-2822 Packing List

System Pack	Nuvo-2822 series	Qty
1	Nuvo-2822 series system (If you ordered RAM/ HDD, please verify these items)	1
2	Accessory box, which contains <ul style="list-style-type: none"> ● 2-pin power terminal block ● Screw pack 	1 1

2.2 Nuvo-2822 Series I/O Panel

The Nuvo-2822 I/O panel features USB3.2, USB2.0, HDMI, DP, Ethernet and COM ports.

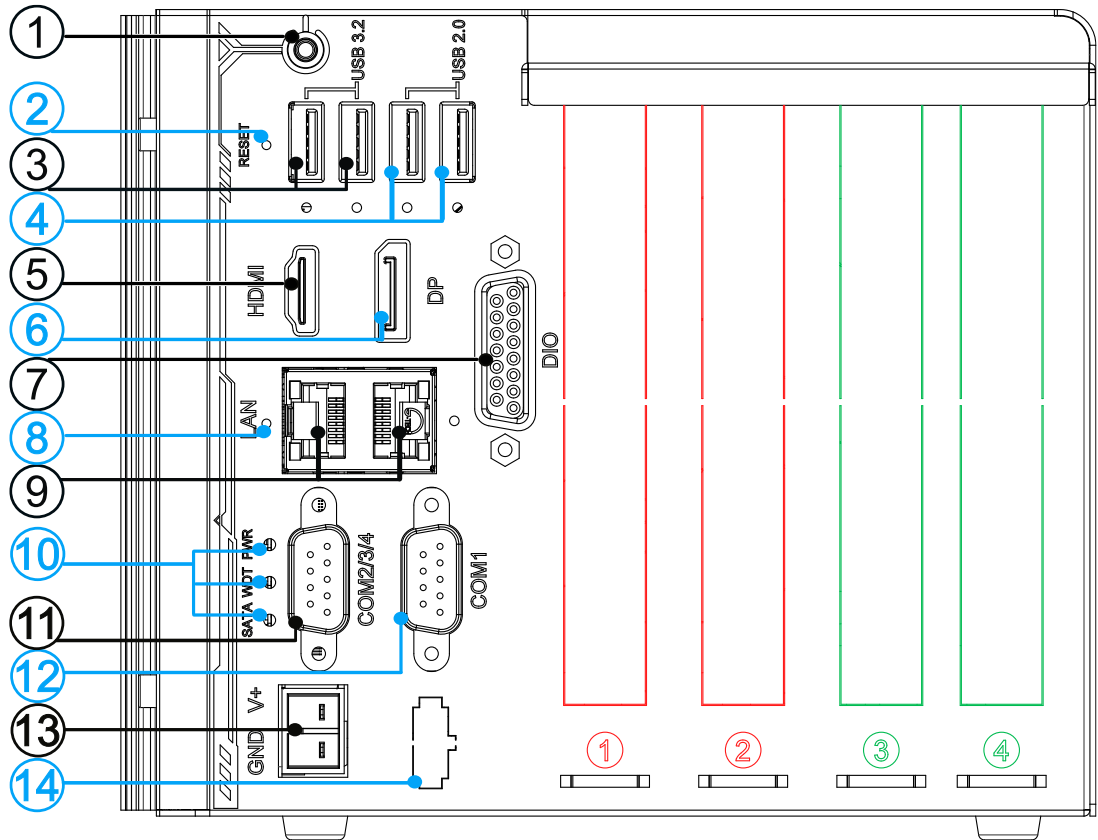

No.	Item	Description
1	Power button	Use this button to turn on or shutdown the system
2	Reset button	Use this button to manual reset the system
3	USB3.2 Gen2	USB3.2 Gen2 offers up to 10Gbps of data-throughput performance
4	USB2.0	USB2.0 offers up to 480Mbits/sec data-throughput performance
5	HDMI	The HDMI port is a high-resolution graphics/ data port supporting up to 3840 x 2160 @ 30Hz
6	DisplayPort	Support display resolutions up to 4096 x 2304. Compatible with HDMI/ DVI via respective adapter/ cable (resolution may vary)
7	Digital input/ output	The DIO port provides 4x digital input and 4x output channels
8	Clear CMOS	Use this button to manually to reset the CMOS to load default BIOS
9	Ethernet port	Gigabit Ethernet ports by Intel® I210-IT
10	Status LED indicator	From top to bottom, the LEDs are PWR (system power), WDT (watchdog timer), SATA (hard disk drive)
11	COM 2/ 3/ 4	COM 2 port is a software-selectable RS-422/ 485 port.

12	COM 1	COM 1 port is a software-selectable RS-232/ 422/ 485 port. The operation mode can be set in BIOS
13	2-pin terminal block	The system accepts 12V - 24V DC power input
14	On/ off control & status LED connector (optional)	Reserved punch-out panel for On/ Off control and status LED extension. Please refer to its installation for details
PCIe slots		Indicated in red are PCIe slots: Slot (1) is x4 Gen3 Slot (2) is x1 Gen3
PCI slots		Indicated in green are PCI 33MHz/ 32-bit 5V PCI slots

2.2.1 Power Button

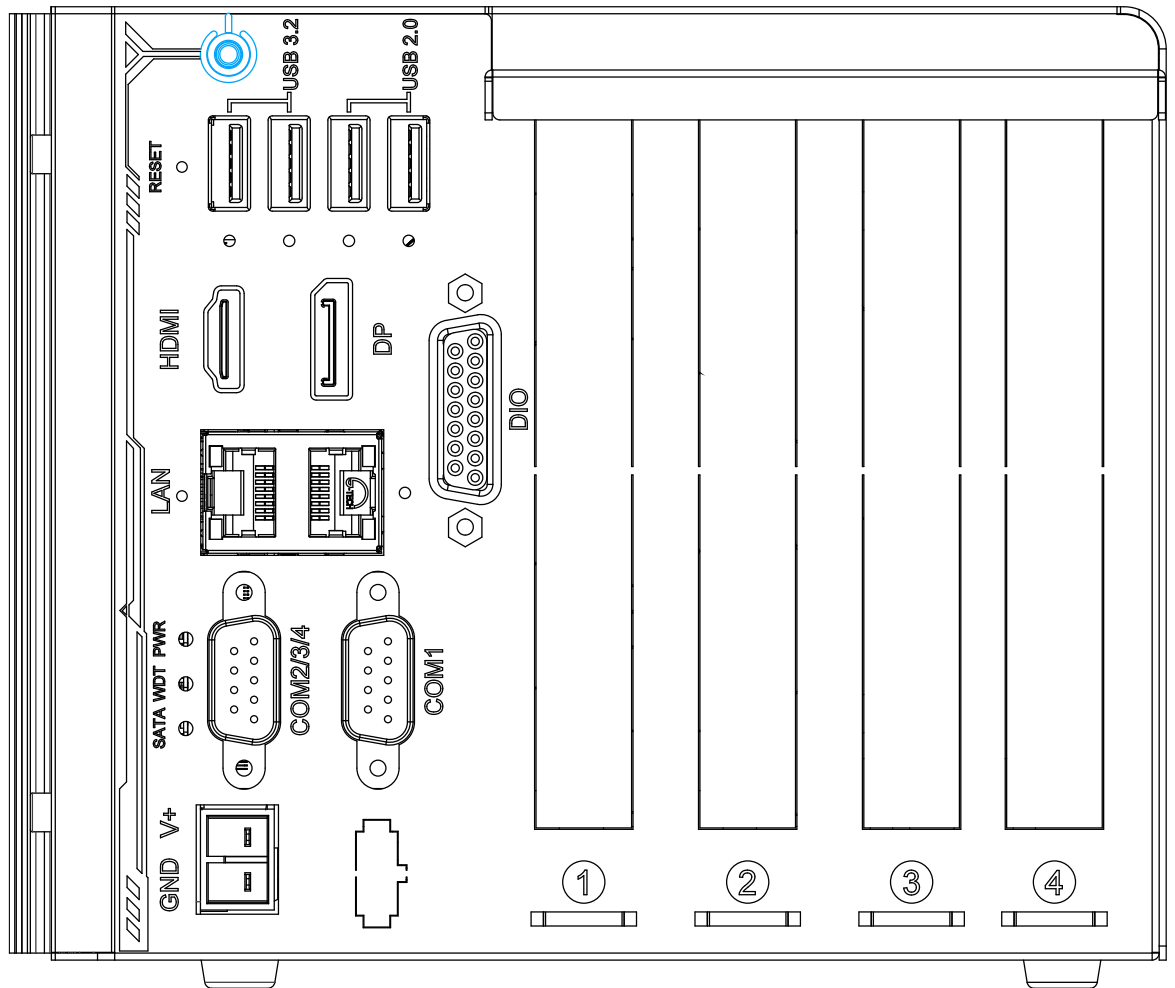

The power button is a non-latched switch for ATX mode on/off operation. To turn on the system, press the power button and the PWR LED should light-up green. To turn off the system, issuing a shutdown command in OS is preferred, or you can simply press the power button. To force shutdown when the system freezes, press and hold the power button for 5 seconds. Please note that there is a 5-second interval between on/off operations (i.e. once the system is turned off, there is a 5-second wait before you can power-on the system).

2.2.2 Reset Button

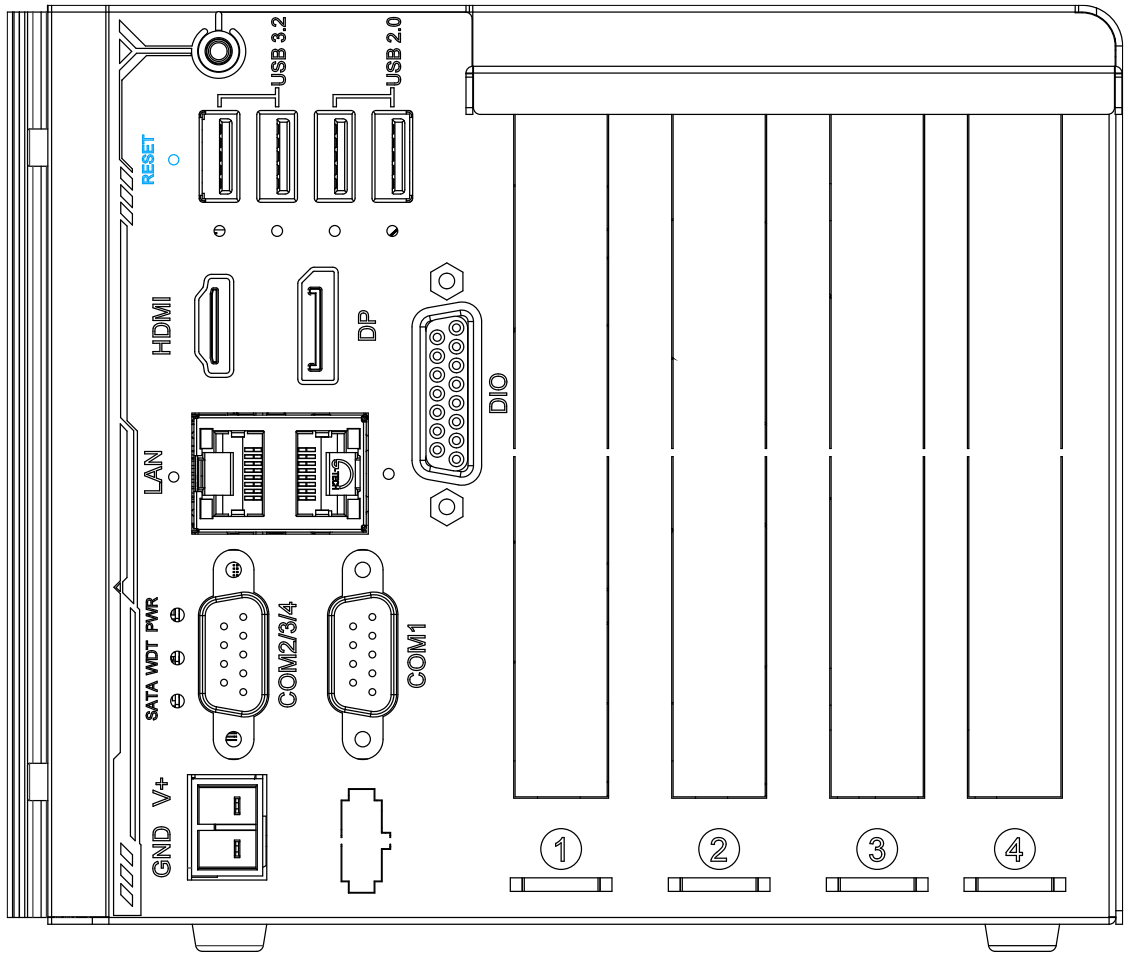

The reset button is used to manually reset the system in case of system halt or malfunction. To avoid unexpected reset, the button is purposely placed behind the panel. To reset, please use a pin-like object (eg. tip of a pen) to access the reset button.

2.2.3 USB3.2 Gen2 Ports

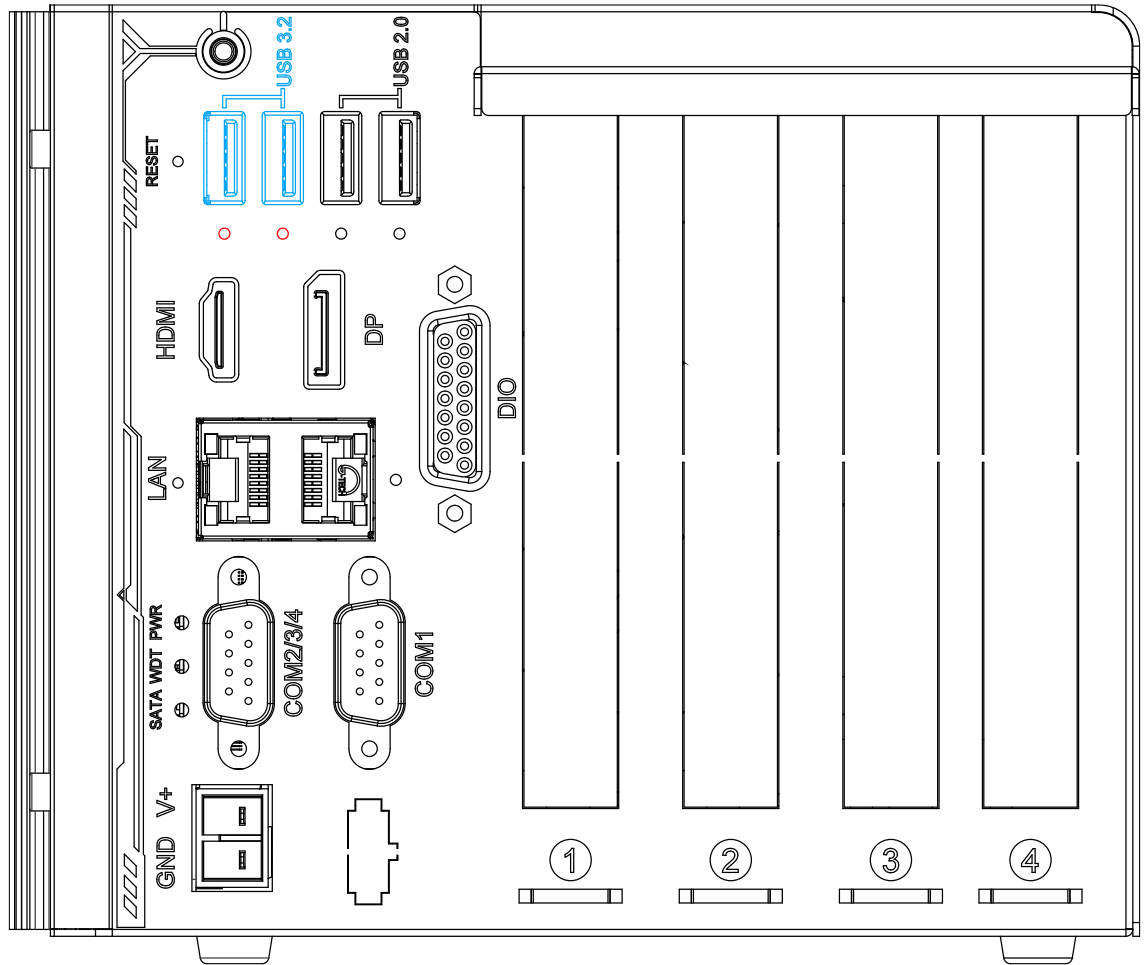

The system offers USB3.2 Gen2 ports with screw-lock mechanism (indicated in **red**). It is backward-compatible with USB 2.0, USB 1.1 and USB 1.0 devices.

2.2.4 USB2.0 Ports

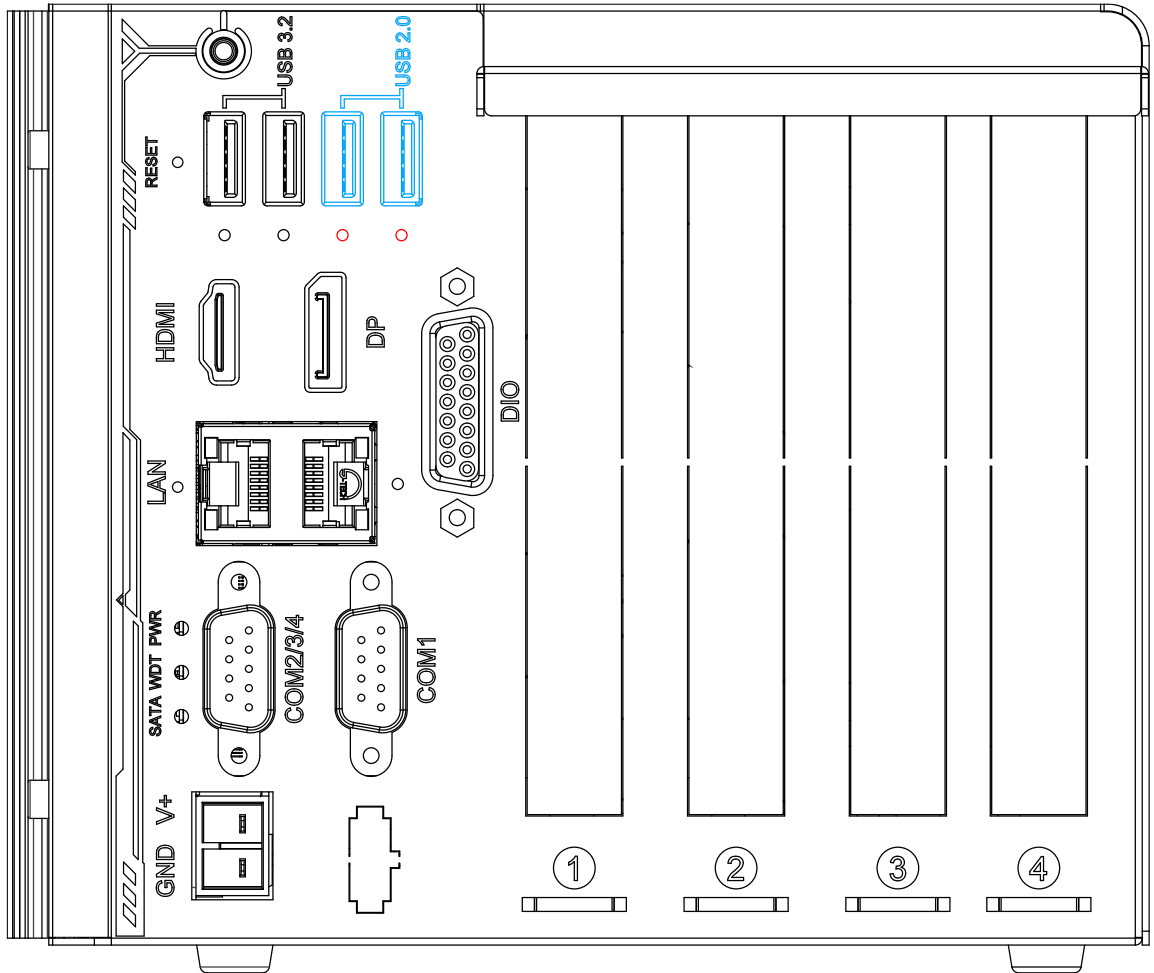

The system offers USB2.0 ports with screw-lock mechanism (indicated in red). It is backward-compatible with USB 1.1 and USB 1.0 devices.

2.2.5 HDMI Port

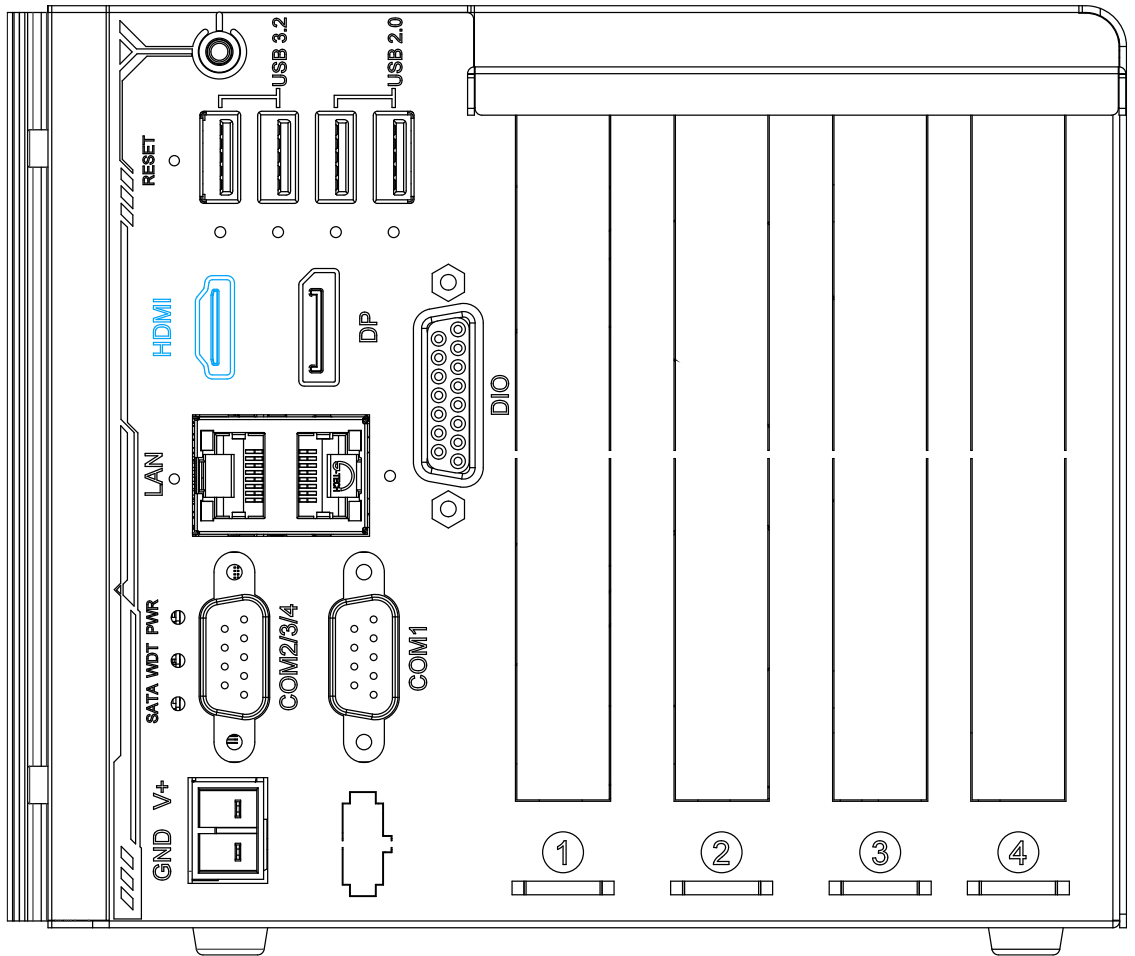

The High-Definition Multimedia Interface (HDMI) port provides uncompressed high-quality digital video and audio transmission between the system and a multimedia display device on a single cable. You can connect to other digital inputs by using a HDMI-to-DVI or HDMI-to-DP cable.

The system supports dual independent display outputs by connecting display devices to HDMI and DisplayPort connection. To support dual display outputs and achieve best DisplayPort output resolution in Windows, you need to install corresponding graphics drivers. Please refer to section OS Support and Driver Installation for details.



HDMI-to-DP

2.2.6 DisplayPort

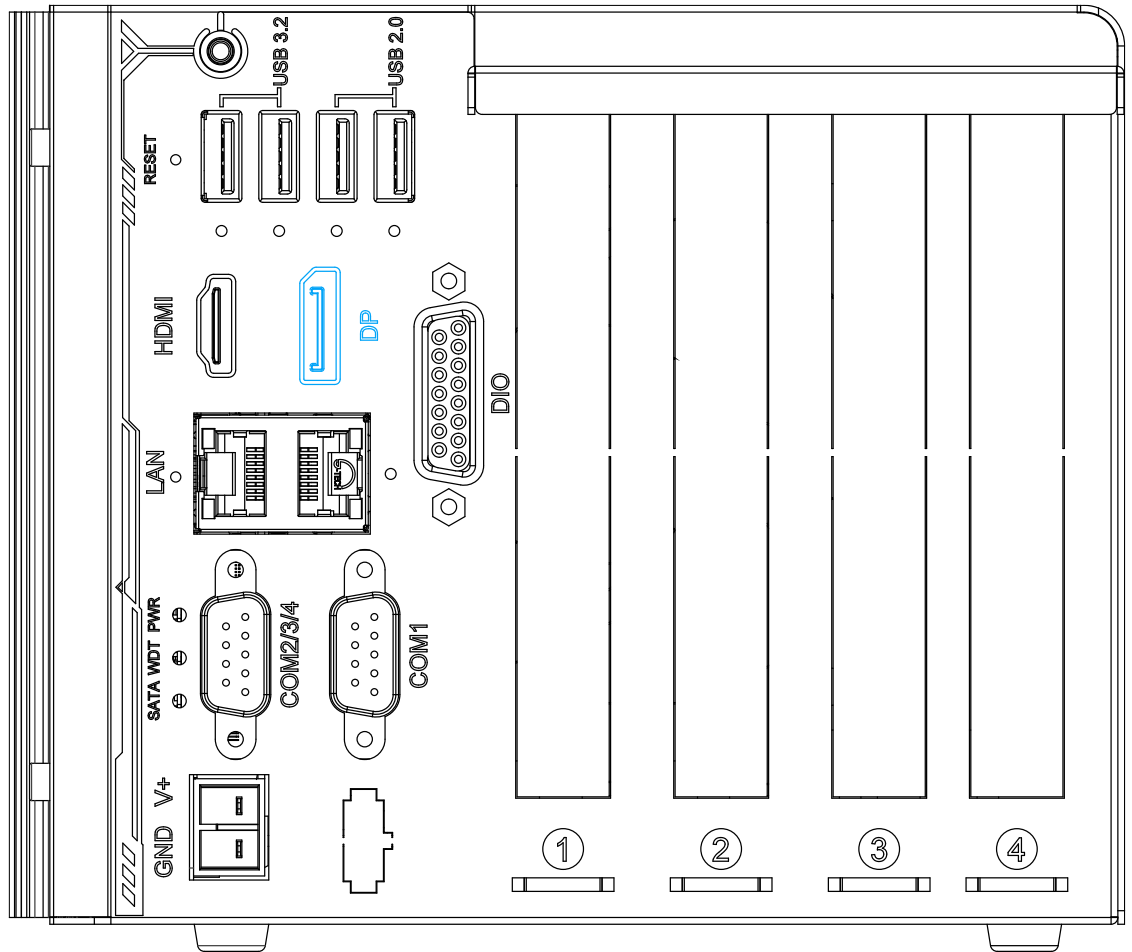

The DisplayPort (DP) output is a digital display interface that mainly connect video source and carry audio to a display device. When connecting a DP, it can deliver up to 4K UHD (4096 x 2304) in resolution. The system is designed to support passive DP adapter/ cable. You can connect to other display devices using DP-to-HDMI cable or DP-to-DVI cable.



DP-to-HDMI



DP-to-DVI

The system supports triple independent display outputs by connecting display devices to VGA, DVI and DisplayPort connection. To support multiple display outputs and achieve best DisplayPort output resolution in Windows, you need to install corresponding graphics drivers. Please refer to section [OS Support and Driver Installation](#) for details.

2.2.7 Digital Input/ Output

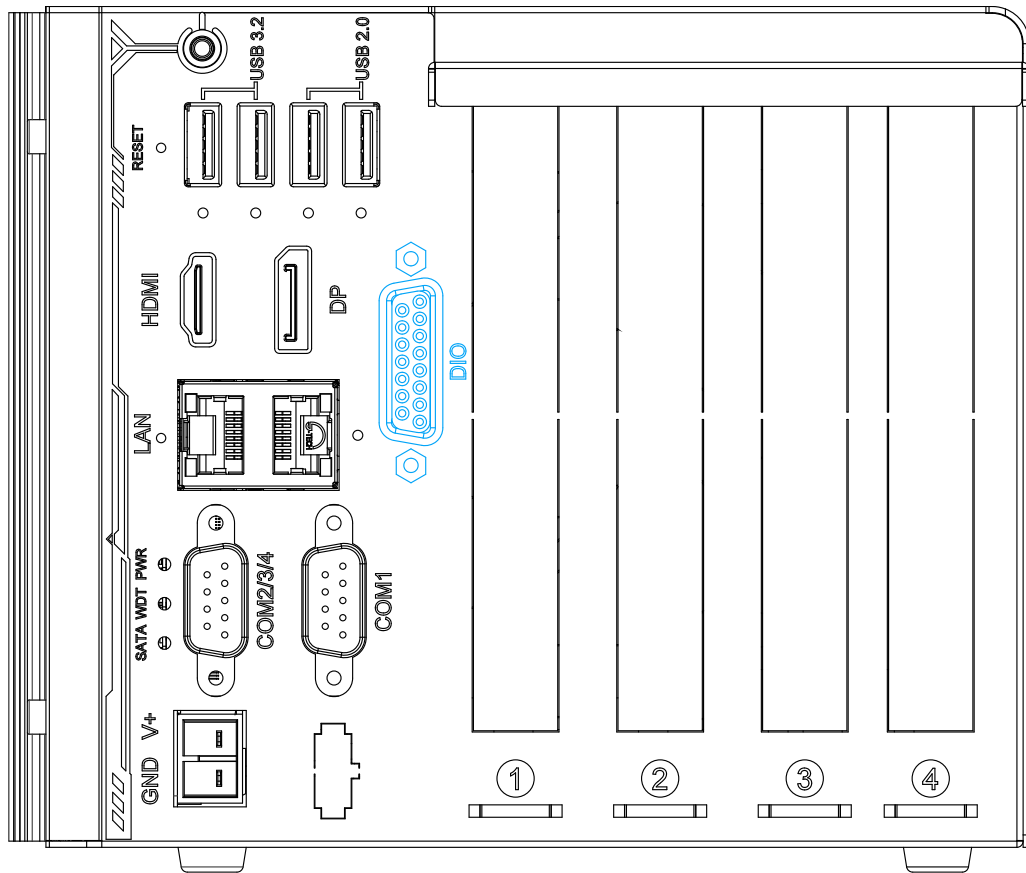

The system provides 4x isolated digital input channels and 4x isolated digital output channels. The DIO functions support polling mode I/O access and DI change-of-state interrupt. Please refer to [Watchdog Timer & Isolated DIO](#) for information on wiring and programming the isolated DIO channels.

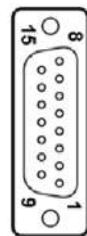

Pin#	Pin Definition	Pin#	Pin Definition
1	DI_0	9	DI_GND
2	DI_1	10	DI_2
3	DI_GND	11	DI_3
4	DO_GND	12	DO_GND
5	DO_0	13	DO_2
6	DO_1	14	DO_3
7	DO_GND	15	-
8	VDD		

Wiring for Digital Input/ Output

The digital input function is implemented using a photo-coupler with an internally series-connected 1kΩ resistor. You need to provide a voltage to specify the logic high/low state. The input voltage for logic high is 5~24V, and the input voltage for logic low is 0~1.5V.

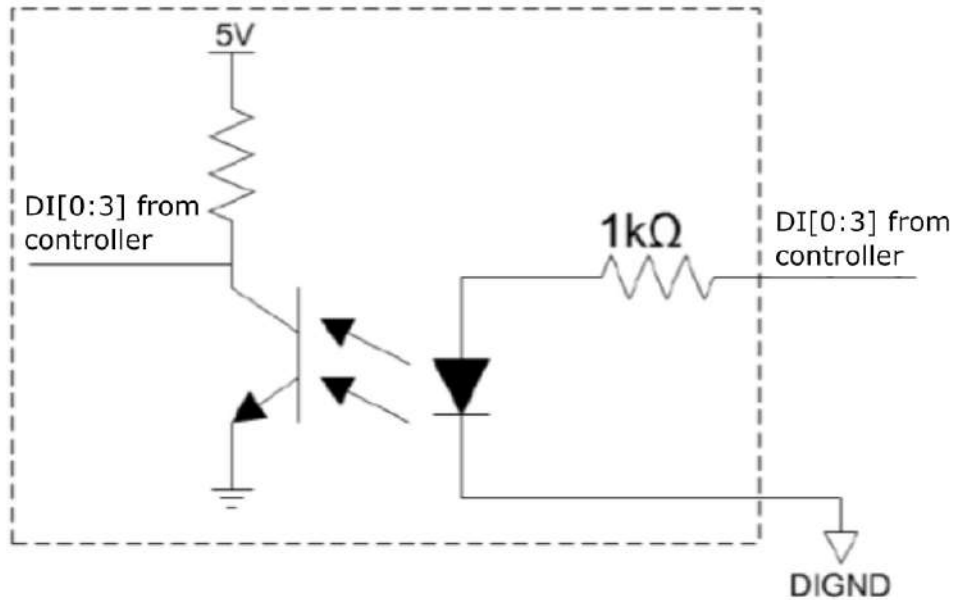

The digital output function is implemented using Power MOSFET + Analog Device iCoupler® component. The DO channels are configured as NO (normally-open) configuration. When you turn on the system, all DO channels have a deterministic state of logic 0 (circuit disconnected from GND return). When logic 1 is specified, MOSFET is activated and GND return path is established. The digital output function on the system supports sinking current connection. The following diagrams are the suggested wiring for DO:

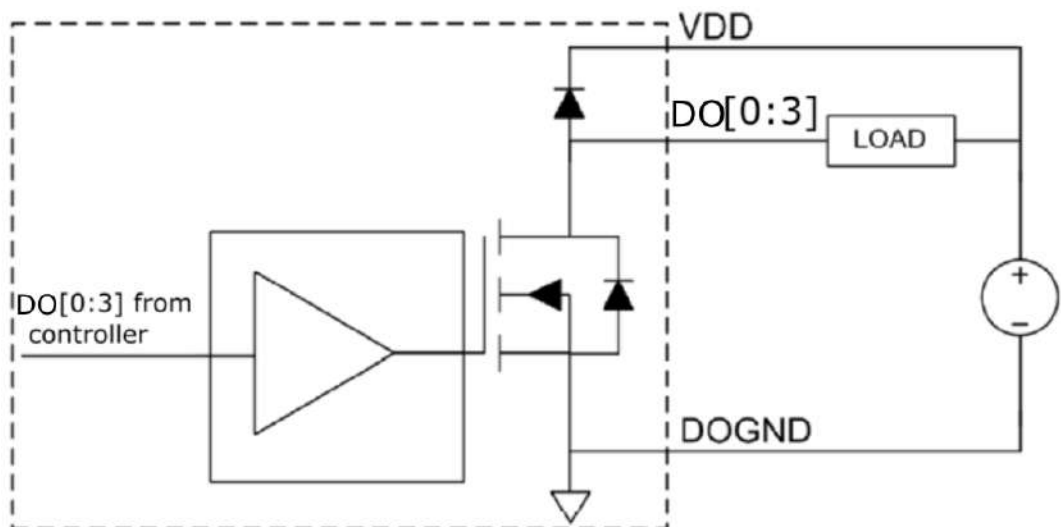

2.2.8 Clear CMOS Button

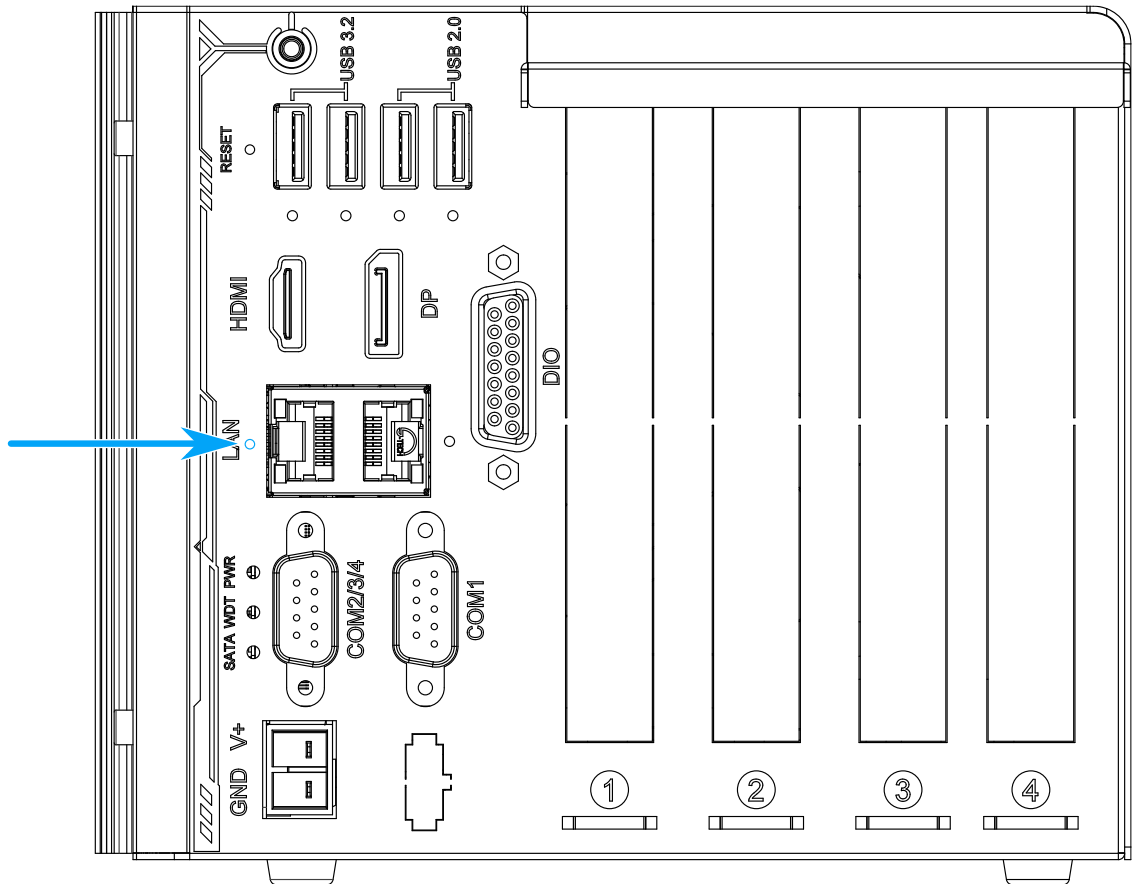

The CMOS Reset button is used to manually reset the motherboard BIOS in case of system halt or malfunction. To avoid unexpected operation, it is purposely placed behind the panel. To reset, disconnect the DC power input, and use the tip of a pen to press and hold for at least 5 seconds to reset the BIOS.



NOTE

You **MUST** disconnect the DC input from the system before resetting the CMOS.



WARNING

Clearing the CMOS will reset all BIOS settings to default and may result in down time!

2.2.9 Gigabit Ethernet Ports

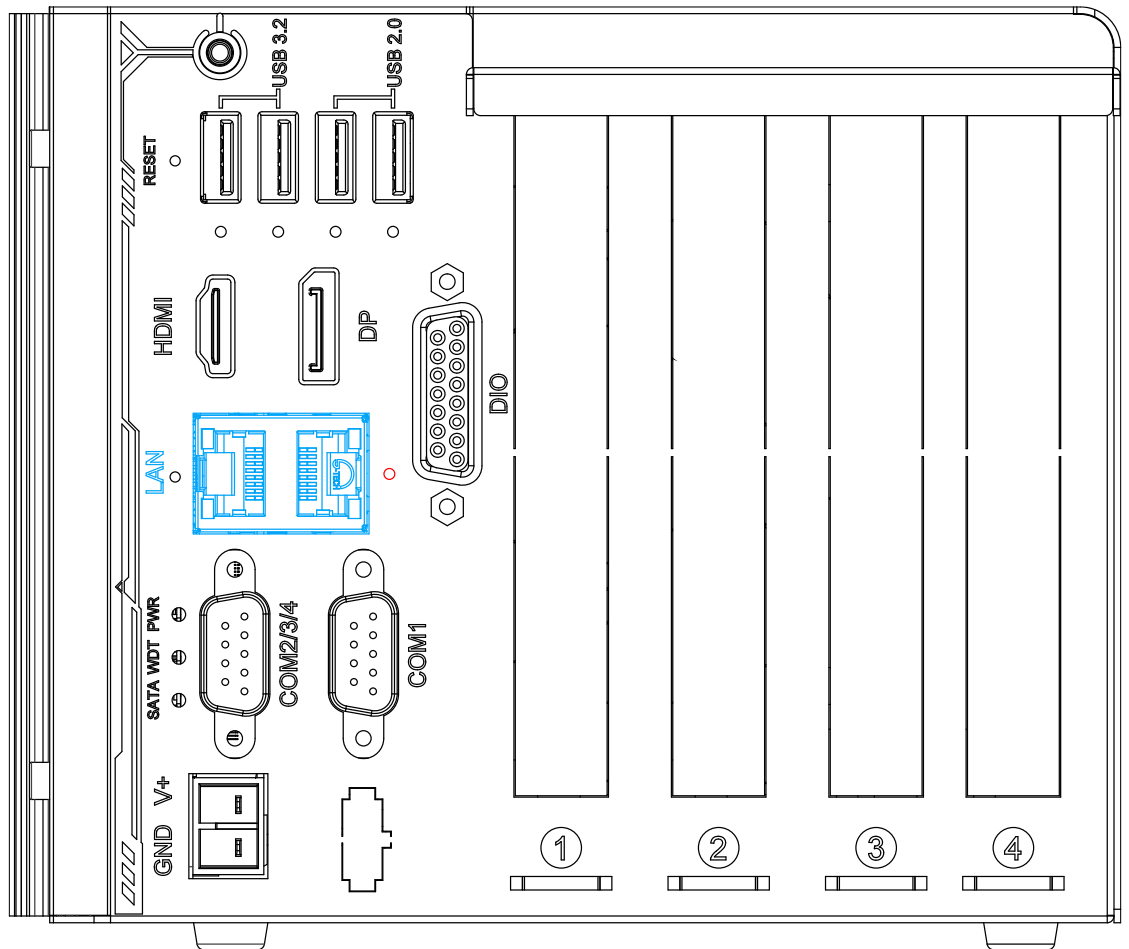

This Gigabit Ethernet port with screw lock mechanism (indicated in red) is implemented using Intel® I210-IT controller. The Ethernet port has one dedicated PCI Express link for maximum performance. Please refer to the table below for LED connection statuses.

Active/Link LED

LED Color	Status	Description
Green	Off	Ethernet port is disconnected
	On	Ethernet port is connected and no data transmission
	Flashing	Ethernet port is connected and data is transmitting/receiving

Speed LED

LED Color	Status	Description
Green or Orange	Off	10 Mbps
	Green	100 Mbps
	Orange	1000 Mbps

To utilize the GbE port in Windows, you need to install corresponding driver for Intel® I210-IT GbE controller.

2.2.10 Status LED Indicators

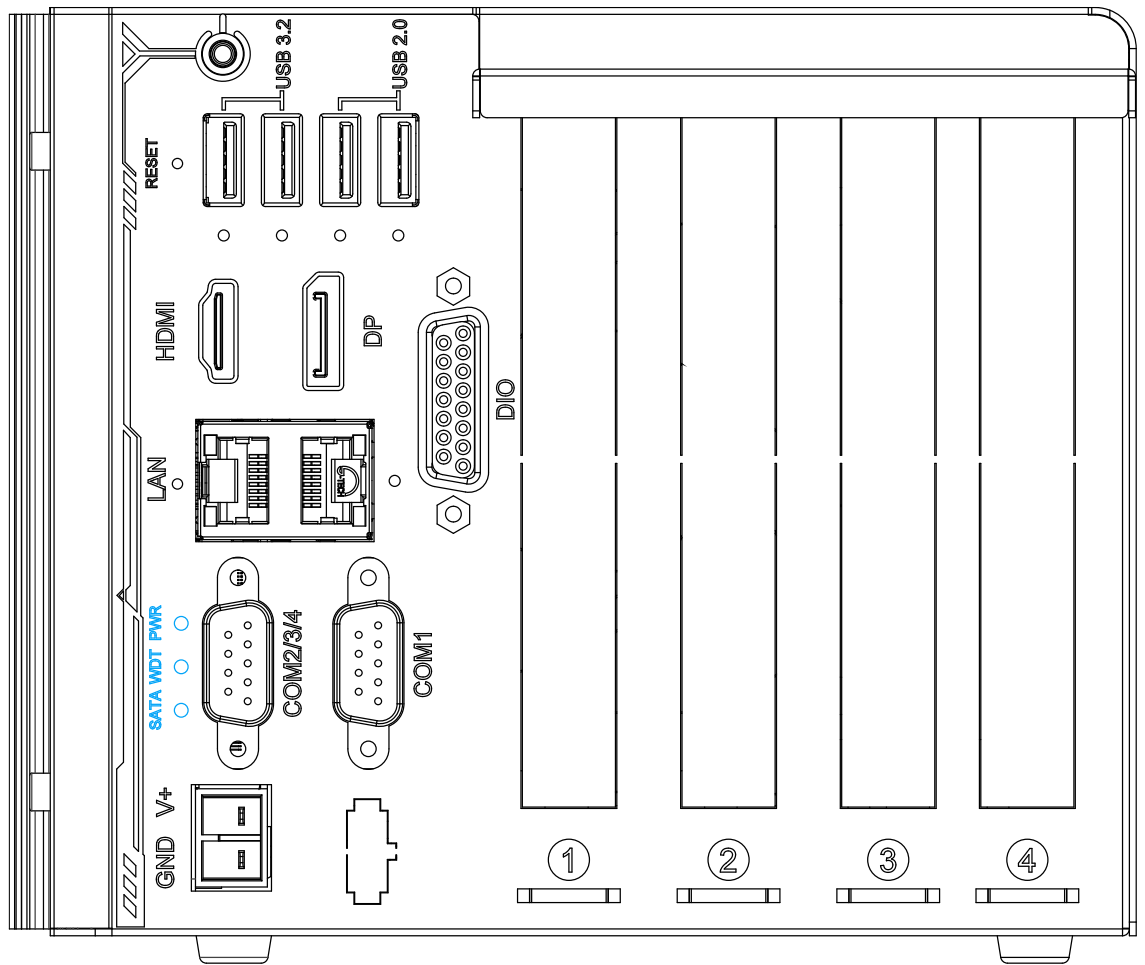

There are three LED indicators on the I/O panel. From top to bottom, they are power (PWR), Watchdog timer (WDT) and hard disk drive activity (SATA). The descriptions of these three LEDs are listed in the following table.

Indicator	Color	Description
PWR	Green	Power indicator, lid when system is on.
WDT	Yellow	Watchdog timer LED, flashing when WDT is active.
SATA	Red	Hard drive indicator, flashing when hard disk drive is active.

2.2.11 COM2/ 3/ 4 Port

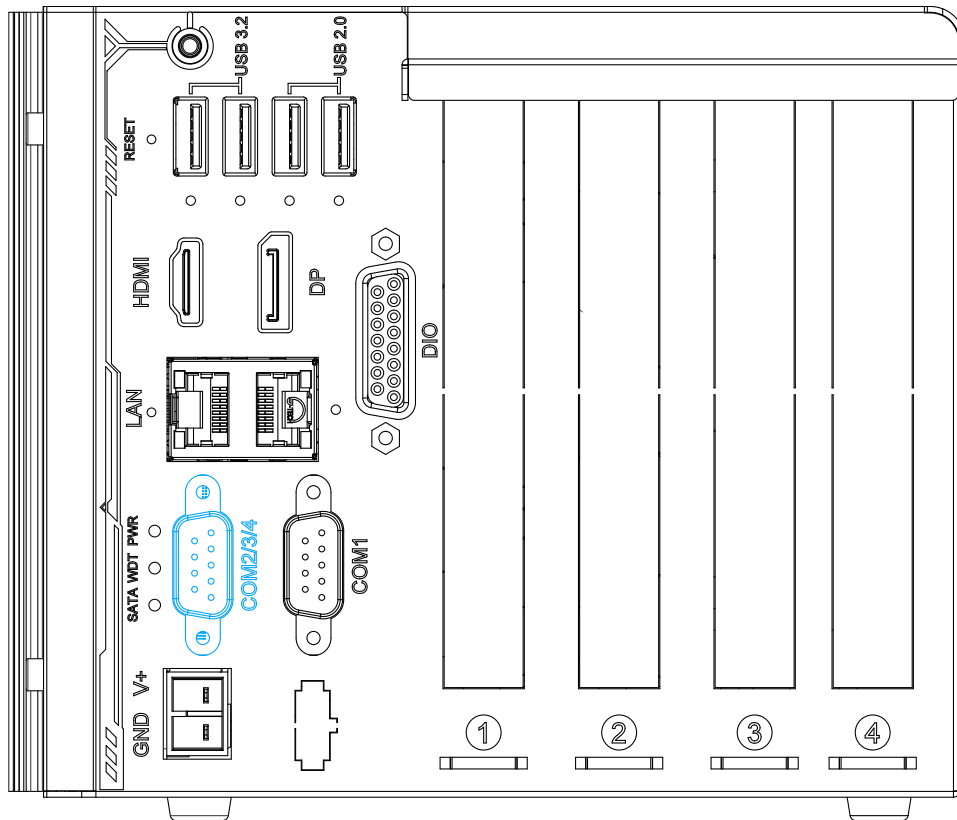

Implemented using industrial-grade ITE8786 Super IO chip (-40 to 85°C) and provide up to 921600 bps baud rate, the D-Sub male connector (COM2/ 3/ 4) can be configured in the BIOS as three 3-wire RS-232 ports (COM2/COM3/COM4). Please refer to [COM2/ 3/ 4 Port Configuration](#) for configuring operation mode. An optional 1-to-3 Y-cable is available to connect three RS-232 devices.

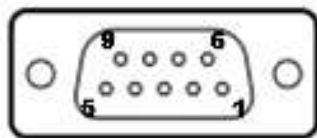

COM2/ 3/ 4 Pin



1-to-3 Y-cable

The following table describes the pin definition of the COM port

Pin#	3-port RS-232 COM2/ 3/ 4		
	COM2	COM3	COM4
1			
2	RX		
3	TX		
4		TX	
5	GND	GND	GND
6		RX	
7			TX
8			RX
9			

2.2.12 COM1 Port

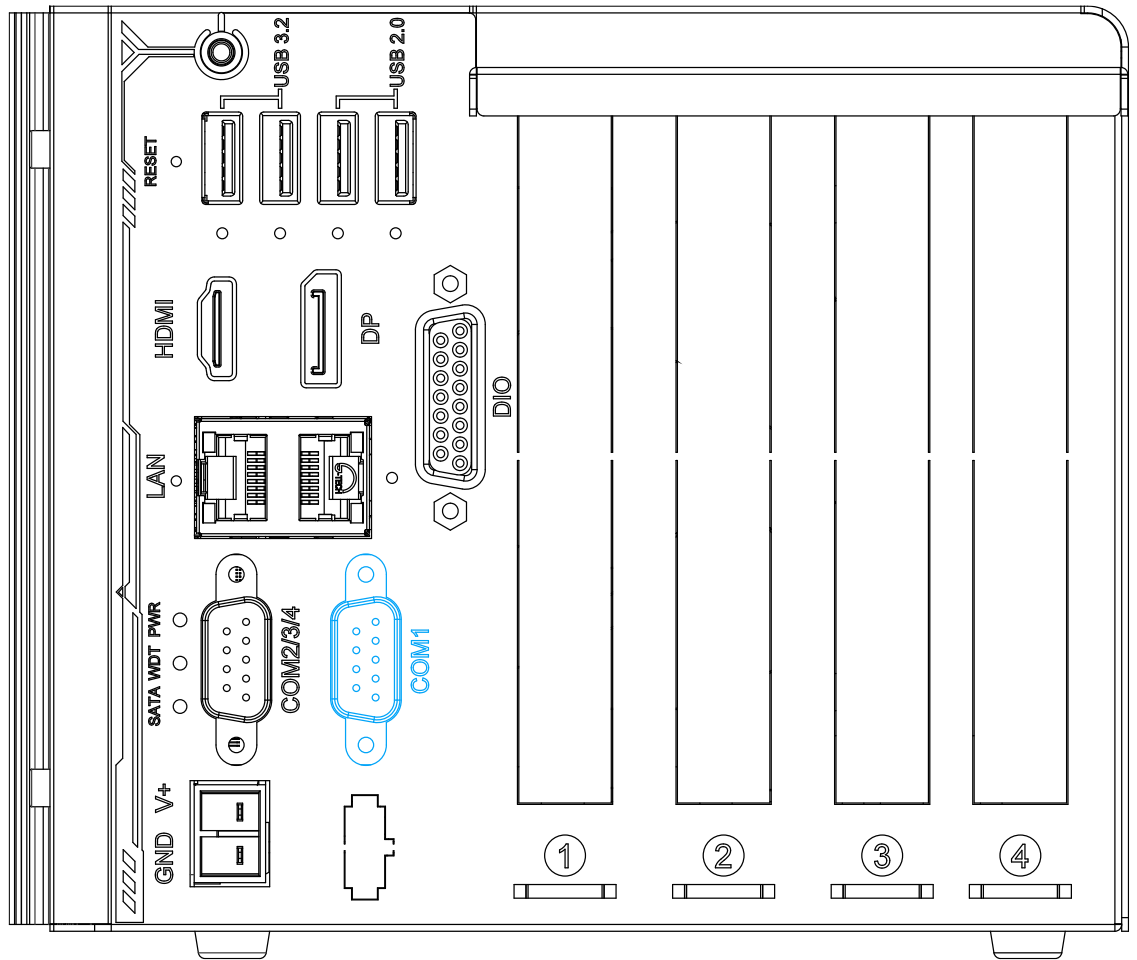

The COM1 port is implemented using industrial-grade ITE8786 Super IO chip (-40 to 85°C) and provide up to 115200 bps baud rate. It is a software-configurable RS-232/422/485 port. The operation mode of can be set in BIOS setup utility. The following table describes the pin definition of the COM port.

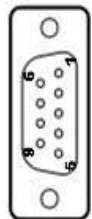

COM Port Pin Definition

Pin#	COM1		
	RS-232 Mode	RS-422 Mode	RS-485 Mode (Two-wire 485)
1	DCD		
2	RX	422 TXD+	485 TXD+/RXD+
3	TX	422 RXD+	
4	DTR	422 RXD-	
5	GND	GND	GND
6	DSR		
7	RTS		
8	CTS	422 TXD-	485 TXD-/RXD-
9	RI		

2.2.13 2-Pin Terminal Block for DC Input

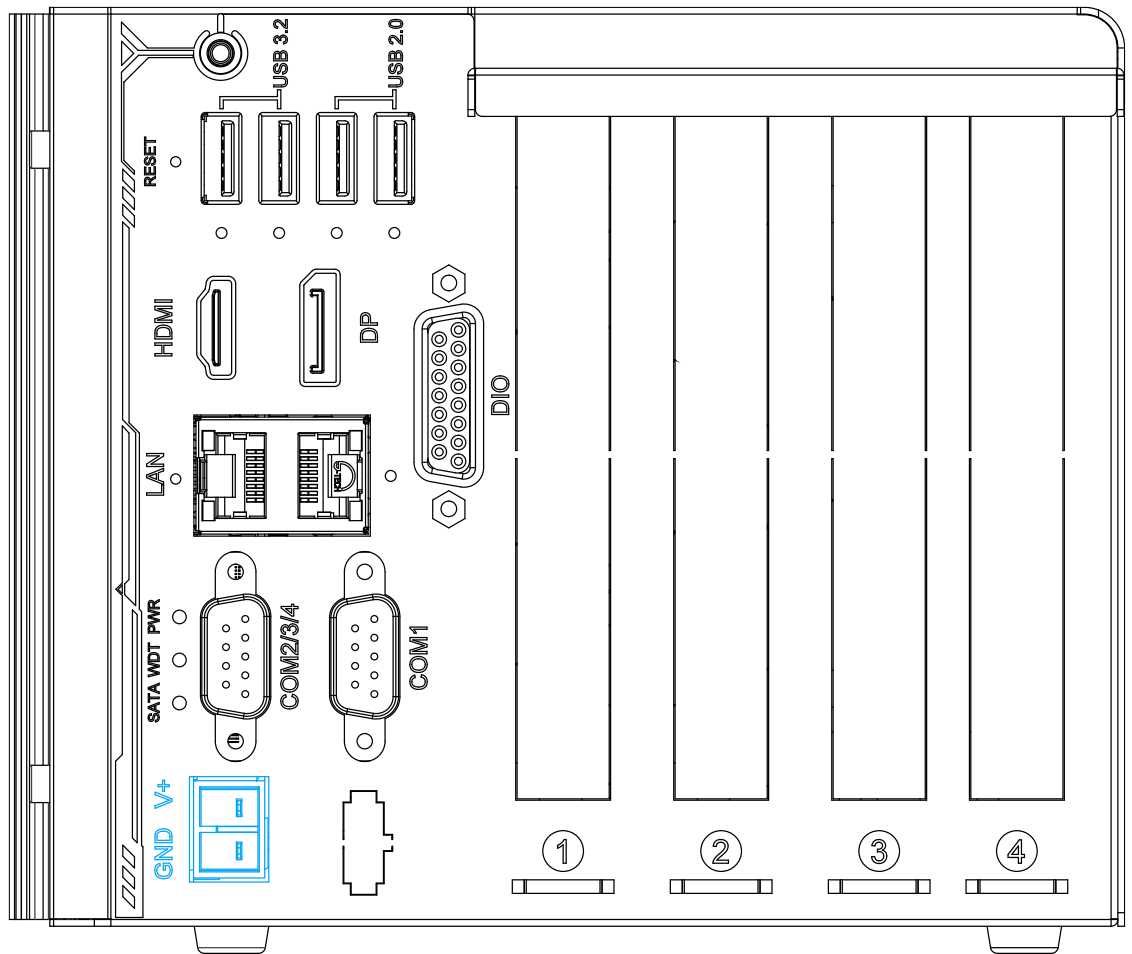

The system accepts a wide range of DC power input from 12V to 24V via 3-pin pluggable terminal block, which is fit for field usage where DC power is provided. And the screw clamping connection of the terminal block gives a very reliable way of wiring DC power.

Symbol	Description
GND	Negative polarity (ground) of DC input
V+	Positive polarity of DC input

 **WARNING**

*Please make sure the voltage of DC power is correct before you connect it to the system.
Supplying a voltage over 24V will damage the system.*

2.2.14 Reserved Panel for On/ Off Ctrl & Status LED Connector (Optional)

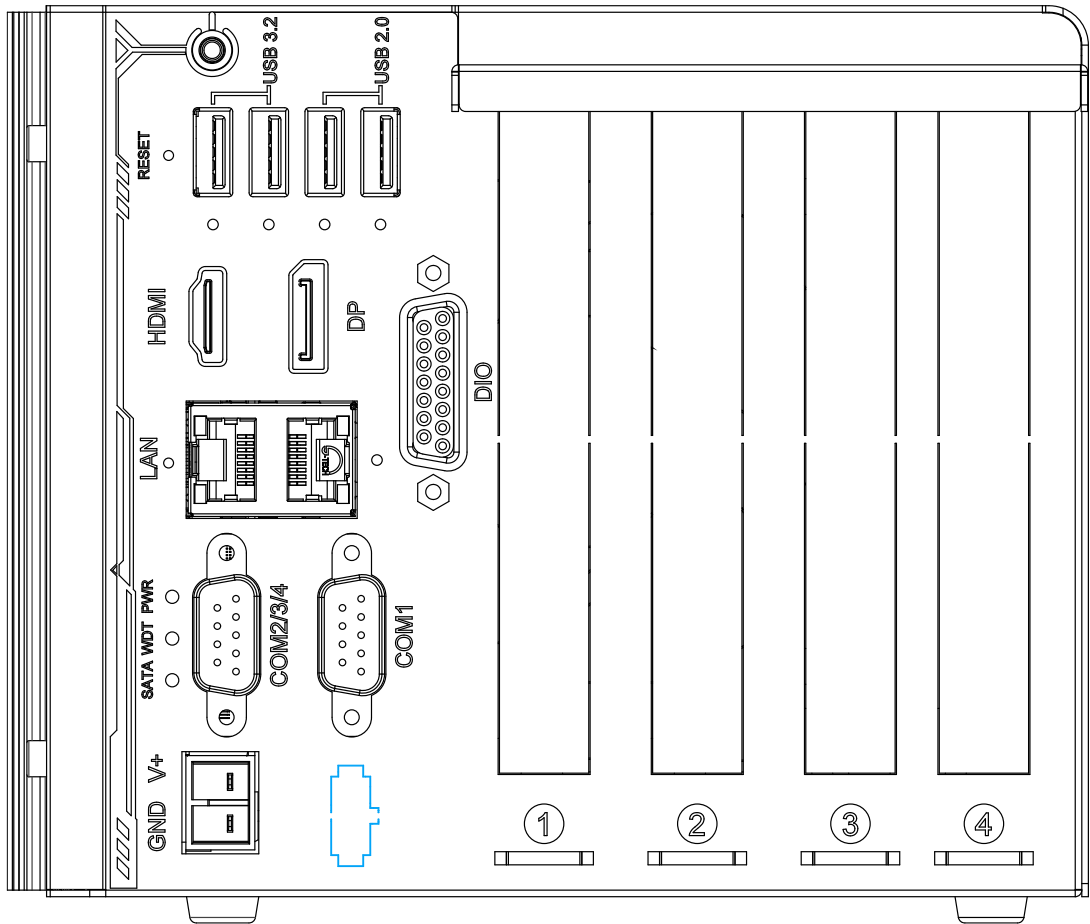

When the system is placed inside a cabinet, it's useful to connect the on/ off controls and the system status to the external panel. The system provides an optional 2x6, 2.0mm pitch pin header to output system status such as power, HDD, watchdog timer, and control system on/off remotely.

2.3 Internal I/O Functions

In addition to I/O connectors on the front panel, the system also provides internal on-board connectors, such as M.2 expansion, DRAM, PCIe and PCI slots, etc. In this section, we'll illustrate these internal I/O functions.

2.3.1 SODIMM DRAM Slot

The system motherboard supports single module DDR5 4800MHz SODIMM up to 16GB capacity.



 **NOTE**

When changes are made to DRAM module(s), such as additionally install or remove and re-install (into the same/ different slot, it will result in an approximately 30 - 60 seconds delay when booting up for the first time after such change(s).

2.3.2 M.2 2280 (M-key) Slot (SATA Signal Only) for SSD

The system has an M.2 2280 slot (SATA signal only) for you to install an M.2 SATA SSD for faster access over traditional hard disk drives.

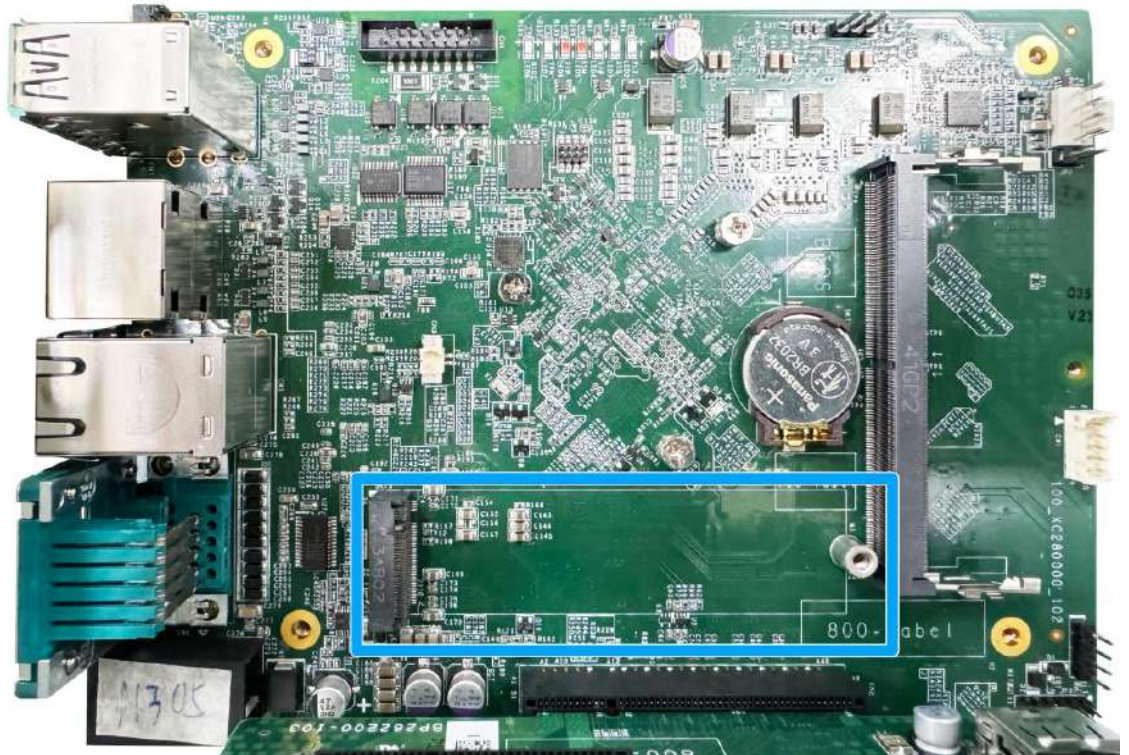

NOTE

The M.2 slot is only compatible with SATA signal M.2 SSD only.

2.3.3 On/ Off Ctrl & Status Output

For an application which places Nuvo-2822 inside a cabinet, it's useful to output the system status to external LED indicators so that users can check how the system's running. The system provides a 2x6, 2.0mm pitch pin header to output system status such as power, HDD, watchdog timer, and control system on/off remotely. The status LED output has a built-in series-resistor and provides 10mA current to directly drive the external LED indicators. System on/off control is also provided so you can use an external non-latched switch to turn on/off the system exactly the same as the power button on the front panel. The following table describes the pin definition of the status LED output.



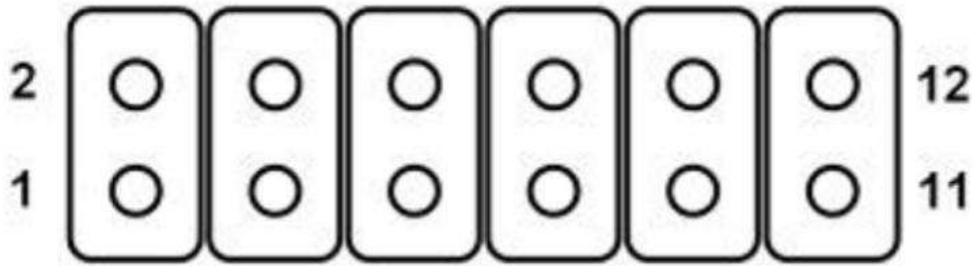

Pin#	Definition	Description
1	WDT_LED-	[Output] Watchdog timer indicator, flashing when Watchdog timer is active
2	WDT_LED+	
3	UID_LED-	[Output] User defined LED, reserved for future usage
4	UID_LED+	
5	HDD-	[Output] Hard drive indicator, flashing when SATA hard drive is active.
6	HDD+	
7	Power_LED-	[Output] System power indicator, on if system is turned on, off if system is turned off.
8	Power_LED+	
9	Ctrl-	[Input] Remote on/off control, connects to an external switch to turn on/off the system (polarity is negligible).
10	Ctrl+	
11	NA	Un-used pin
12	NA	

3 System Installation

Before disassembling the system enclosure and installing components and modules, please make sure you have done the following:

- It is recommended that only qualified service personnel should install and service this product to avoid injury or damage to the system.
- Please observe all ESD procedures at all times to avoid damaging the equipment.
- Before disassembling your system, please make sure the system has powered off, all cables and antennae (power, video, data, etc.) are disconnected.
- Place the system on a flat and sturdy surface (remove from mounts or out of server cabinets) before proceeding with the installation/ replacement procedure.

3.1 Disassembling the System

To access system internal components, the system needs to be disassembled. To disassemble the system enclosure, you need to remove the screws indicated on the enclosure.

1. On the panel, remove the screws indicated.



2. Remove the screws indicated on the side panel.



3. Remove the screw indicated on the rear panel.

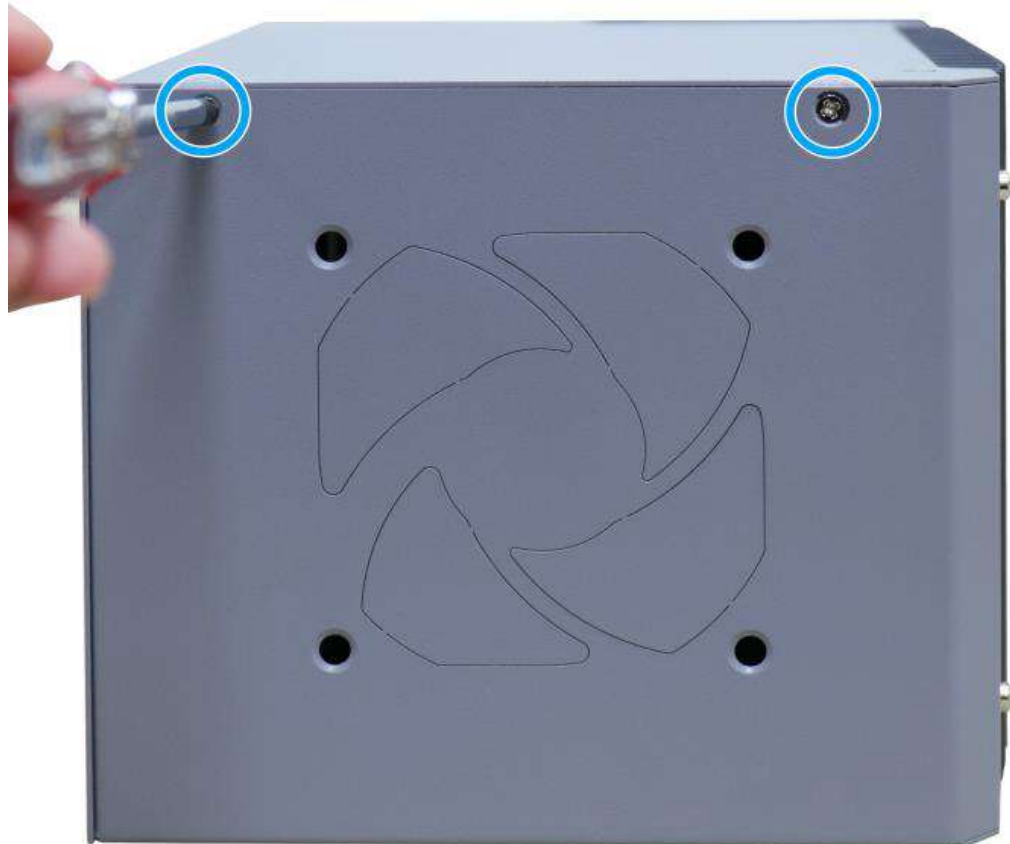

4. Gently lift the L-shape cover panel to separate it from the enclosure.



5. Once the L-shaped panel has been removed, remove the four (4) screws indicated.

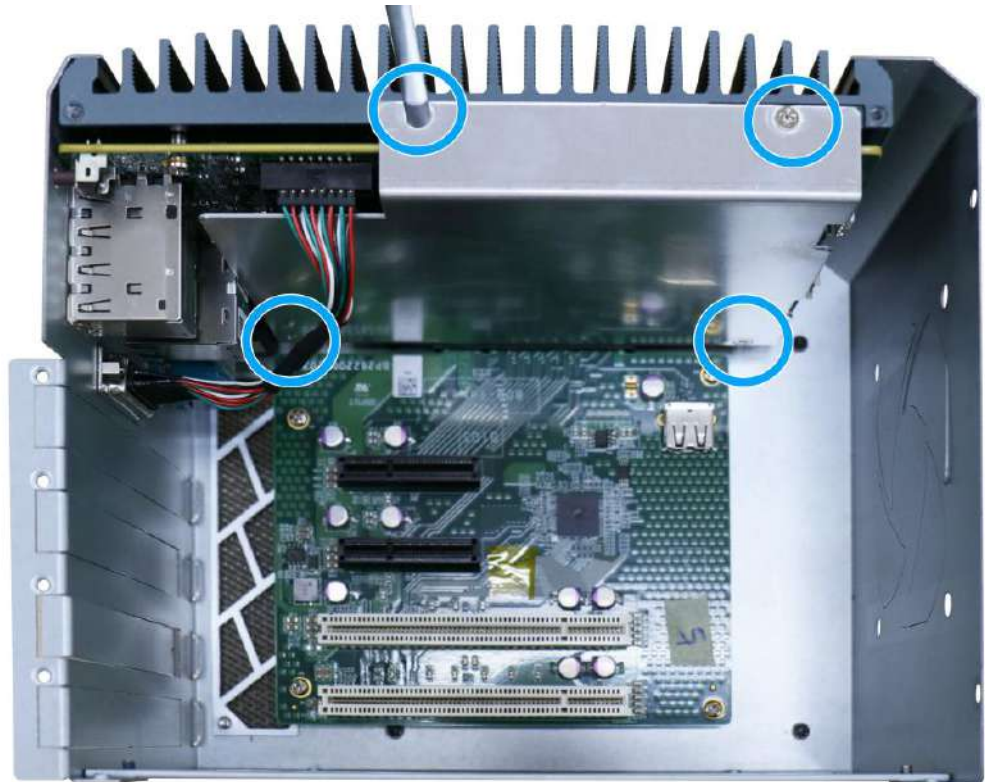

6. Remove the heatspreader on the motherboard to gain access to all internal expansion slots and components



3.2 Installing Internal Components

3.2.1 DDR5 SO-DIMM Installation

There is a SO-DIMM memory slot (indicated in **blue**) on the motherboard that supports a total maximum of 16GB non-ECC DDR5-4800. Please follow the procedures below to replace or install the memory modules.

1. Please refer to the section “[Disassembling the System](#)”.
2. Locate the SODIMM memory module slots on the motherboard.

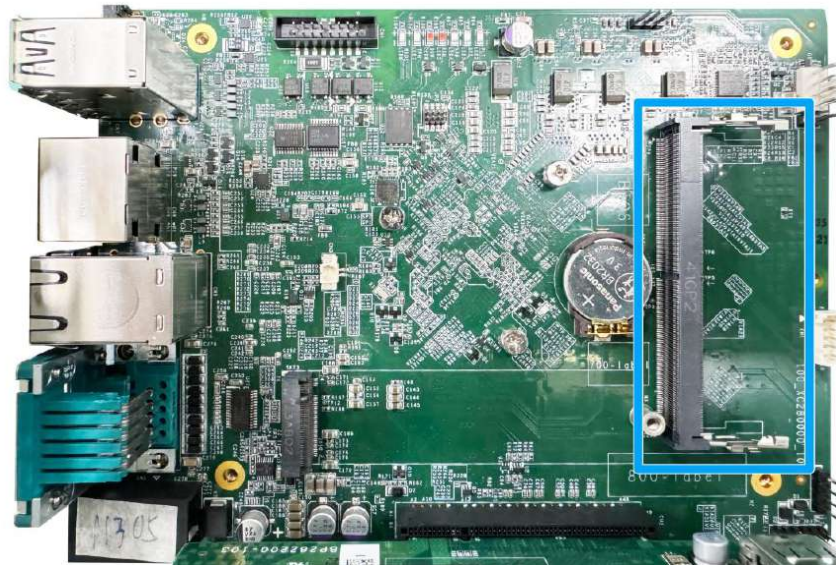

3. To install the memory module, insert gold fingers into the slot at 45-degree angle, push down on the memory module to clip the module into position.

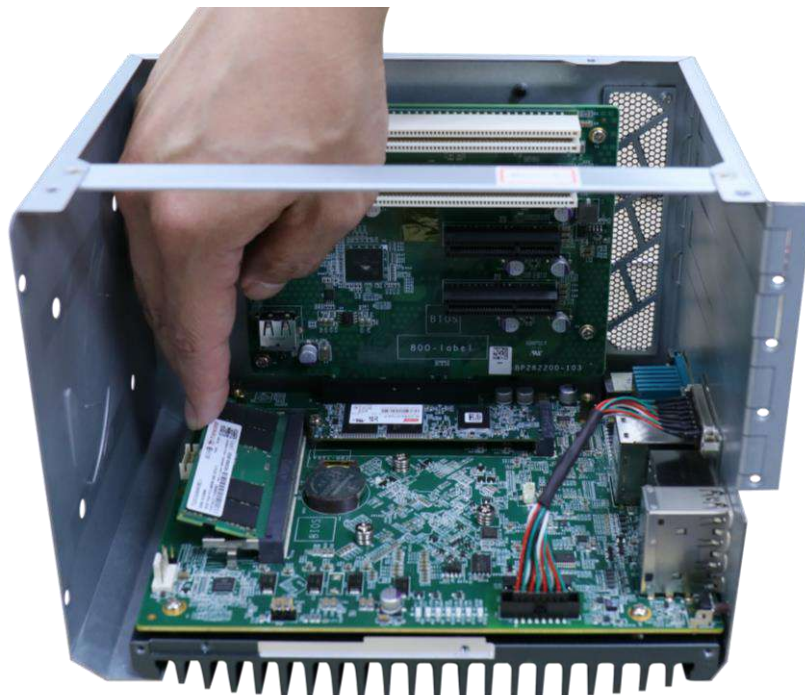

4. Push the memory module down until it is clipped-in, and remove the corresponding protection film off the thermal pad.

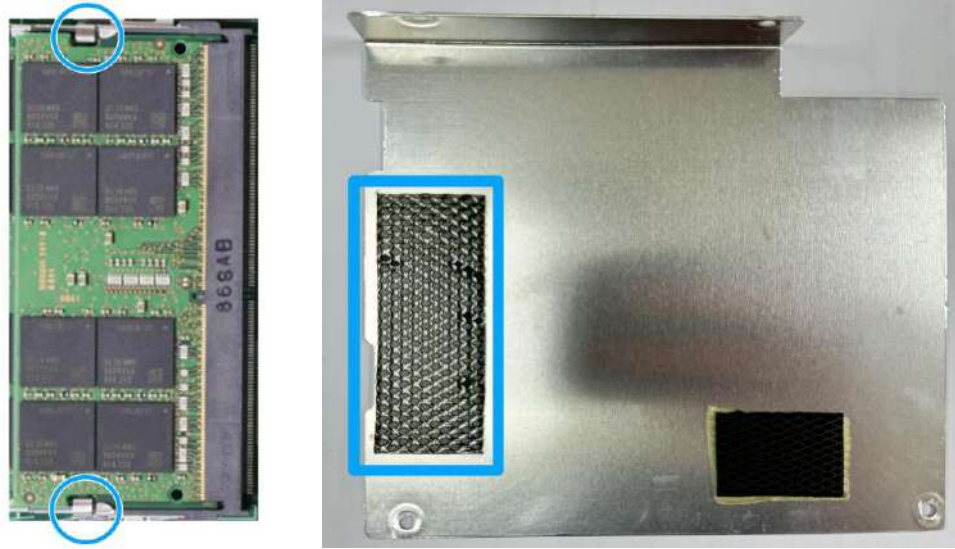

5. Reinstall the heat spreader by securing the screws indicated when done.

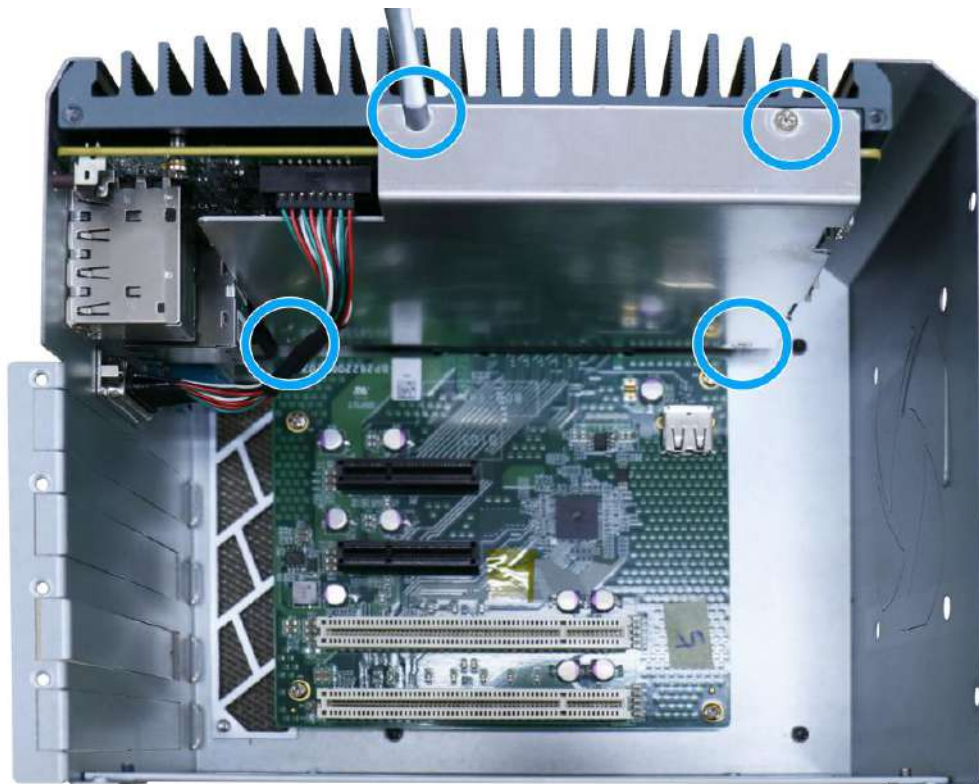

6. [Reinstall the system enclosure](#) and panel when done.
7. If you need to install other components, please refer to respective sections.

3.2.2 M.2 2280 SSD Installation

The system has a SATA signal M.2 2280 slot for you to install an M.2280 SATA SSD. For installation, please refer to the following instructions.

1. Please refer to the section “[Disassembling the System](#)”.
2. Locate the M.2 2280 expansion slot.

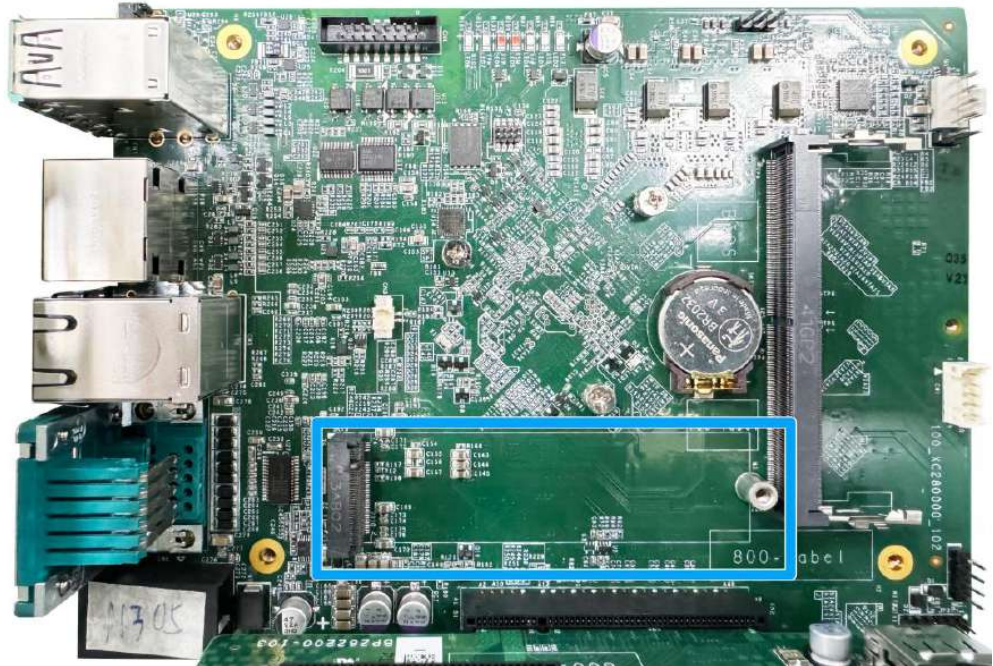

3. Insert the SSD module on a 45 degree angle into the expansion slot.



- Secure the module with an M3 P-head screw.

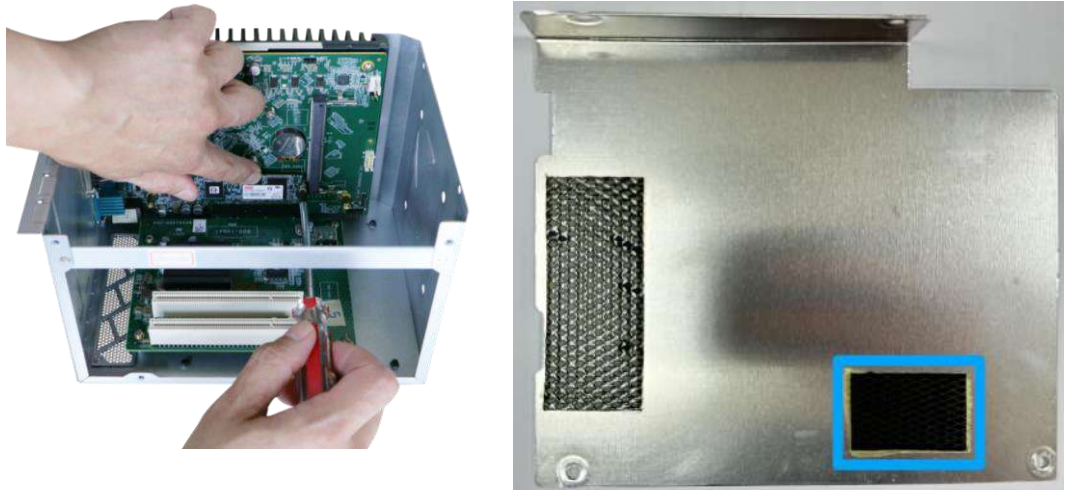

- Reinstall the heat spreader by securing the screws indicated when done.



- [Reinstall the system enclosure](#) and panel when done.
- If you need to install other components, please refer to respective sections.

3.2.3 On/ Off Control & Status LED Cable Installation (Optional)

When the system is placed inside a cabinet, it's useful to connect the on/ off controls and the system status to the external panel. The system provides a 2x6, 2.0mm pitch pin header to output system status such as power, HDD, watchdog timer, and control system on/off remotely. To install the optional cable, please refer to the following procedure:

1. Please refer to the section "[Disassembling the System](#)".
2. Remove the screws indicated on the PCIe/ PCI expansion board.

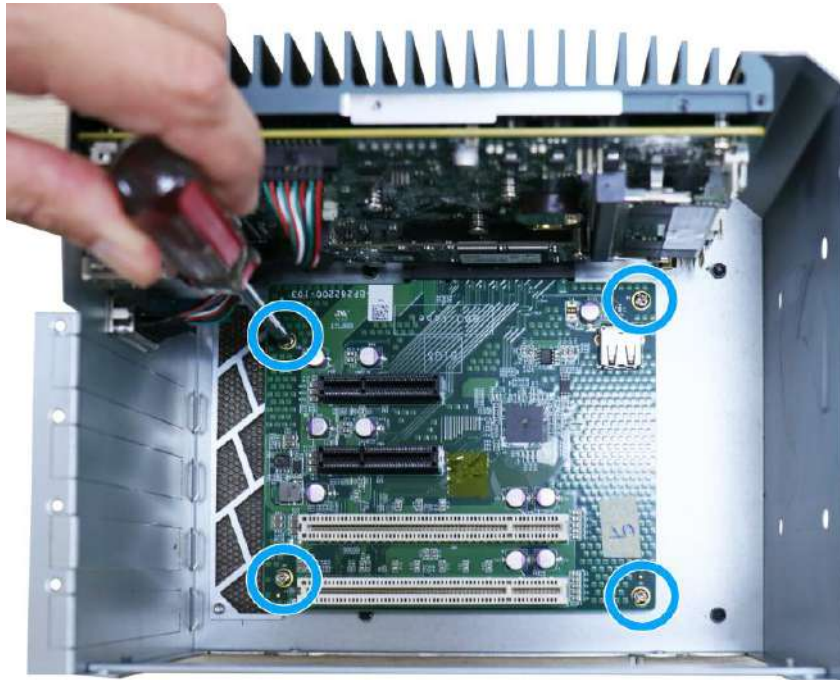

3. Gently disengage the PCIe/ PCI expansion board from the motherboard.

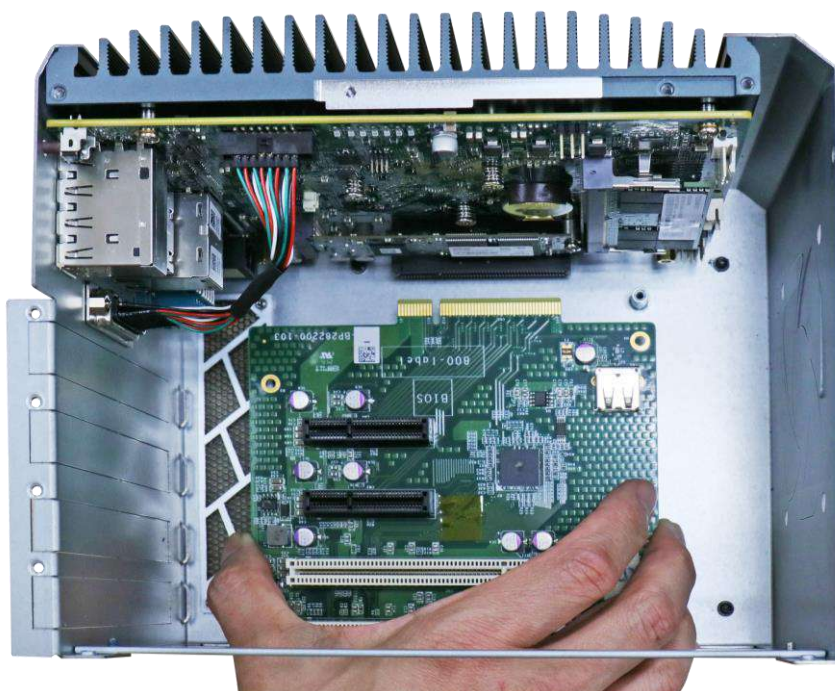

4. Locate the 2x6 pins for On/Off control & status LED output on the bottom right corner of the motherboard.



5. Remove the reserved punch-out panel on the I/O panel.



- Note the pin order, and make sure Pin 1 on the cable (indicated in blue) is plugged into Pin 1 on the motherboard (indicated in red).

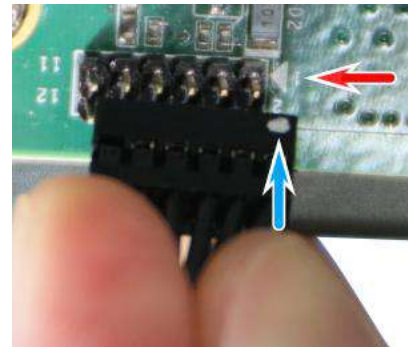
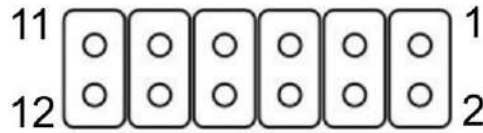

Pin allocation on motherboard

Pin 1 (cable) plugged into Pin 1 (MB)

- When inserting the connector to the I/O panel, make sure the orientation of the plug matches the I/O panel. Push the plug inside-out, make sure it is clipped onto the I/O panel to complete the optional cable installation.

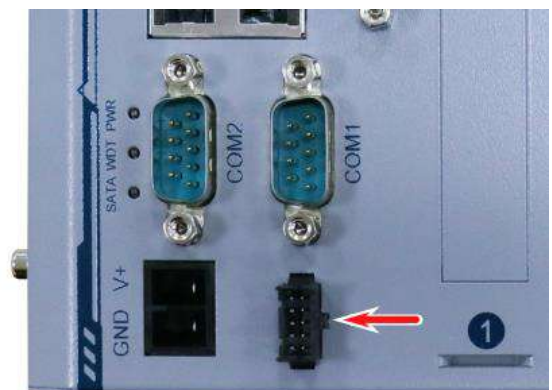

- The orientation of the plug pins is as below.

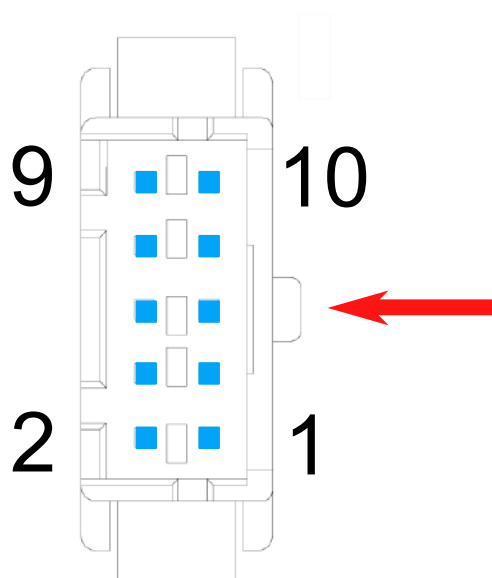

9. For pin definition, please refer to this [section](#).
10. [Reinstall the system enclosure](#) and panel when done.
11. If you need to install other components, please refer to respective sections.

3.2.4 Fan Installation (Optional)

 **NOTE**

The fan kit is recommended if your system is deployed to operate in ambient conditions exceeding 60°C.

Please refer to the following procedure to installation the optional fan kit.

1. Please refer to the section "[Disassembling the System](#)".
2. Remove the reserved punch-out fan panels at the rear.



Reserved punch-out panels

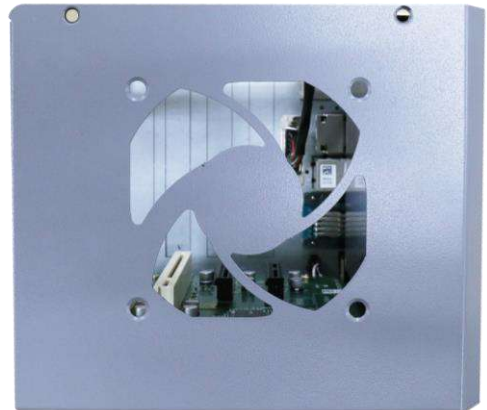

Punch-out panels removed

3. Remove the protection film on the fan filter, match the screw-holes and place it on the fan.



Remove protection film

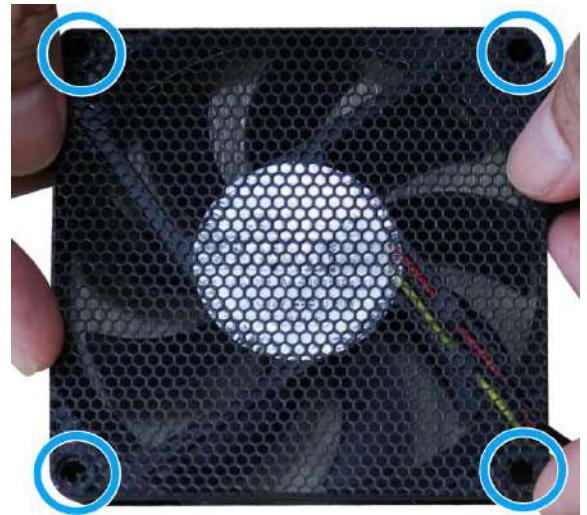

Place filter on fan while matching screw-holes

4. Plug the fan's 3-pin cable onto the motherboard fan connector onto the motherboard.



Motherboard fan connector location

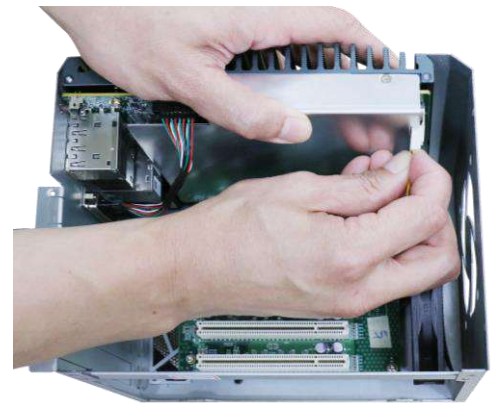

Plug onto motherboard

5. Install the fan on the inside, at the rear end of the enclosure.

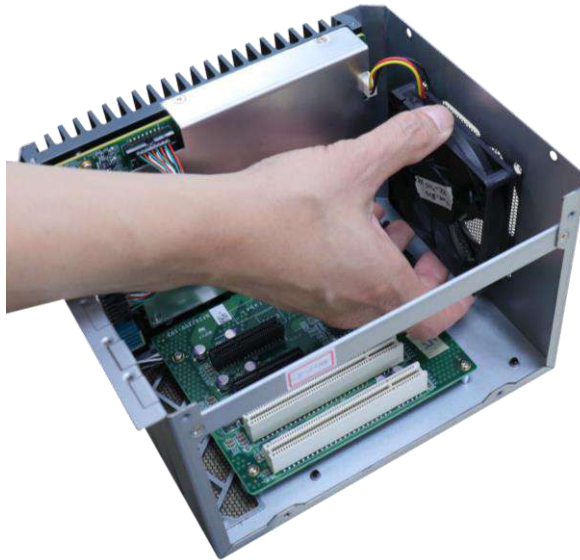

6. Secure with screws to complete the fan installation.

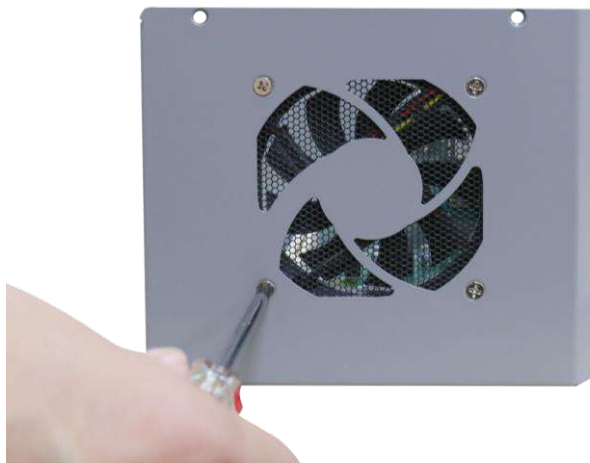

7. [Reinstall the system enclosure](#) and panel when done.
8. If you need to install other components, please refer to respective sections.

3.3 Installing the System Enclosure

1. To reinstall the system enclosure, place the L-shaped panel back onto the system.



2. Secure the screw indicated top of the system.



- Secure the screws indicated on the side panel.



- Secure the screw indicated at the rear to complete the enclosure installation.

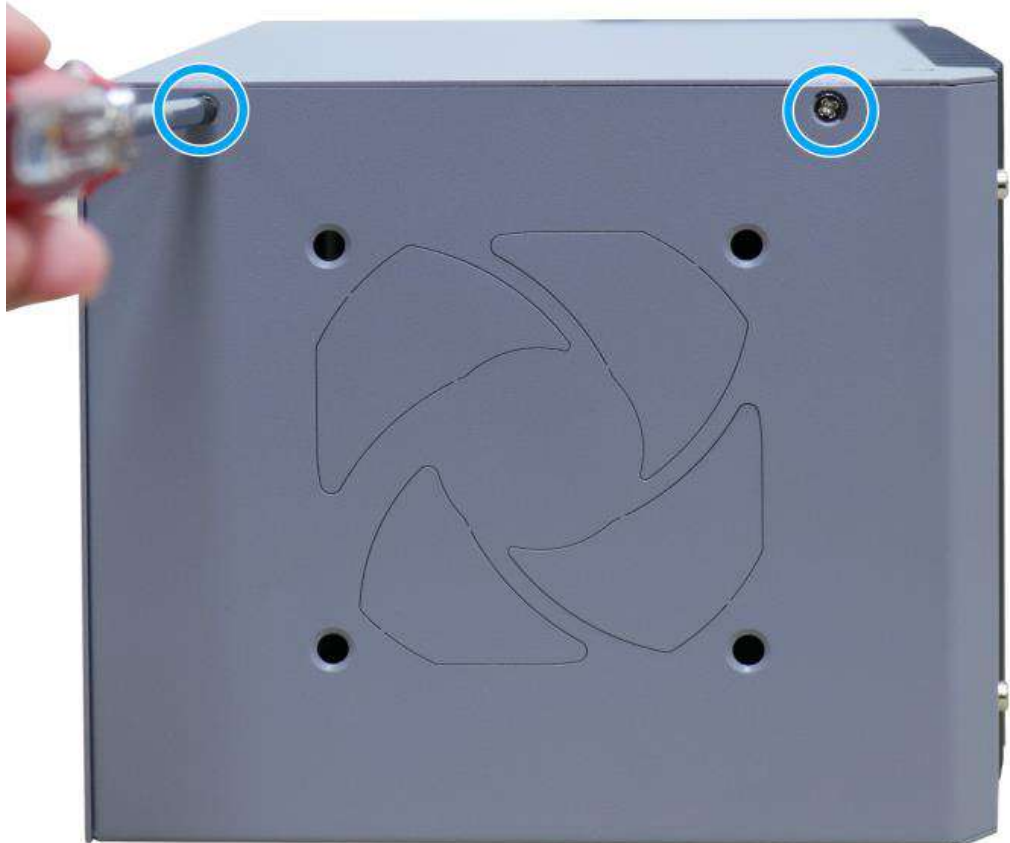

3.4 Wall-mount Bracket Installation

To install the wall-mount bracket, please refer to the exploded illustration below on installing the wall-mount bracket. The bracket and screws can be found in the accessory box.

1. Secure the wall-mount bracket (in **blue**) with the supplied M4 screws (in **red**).

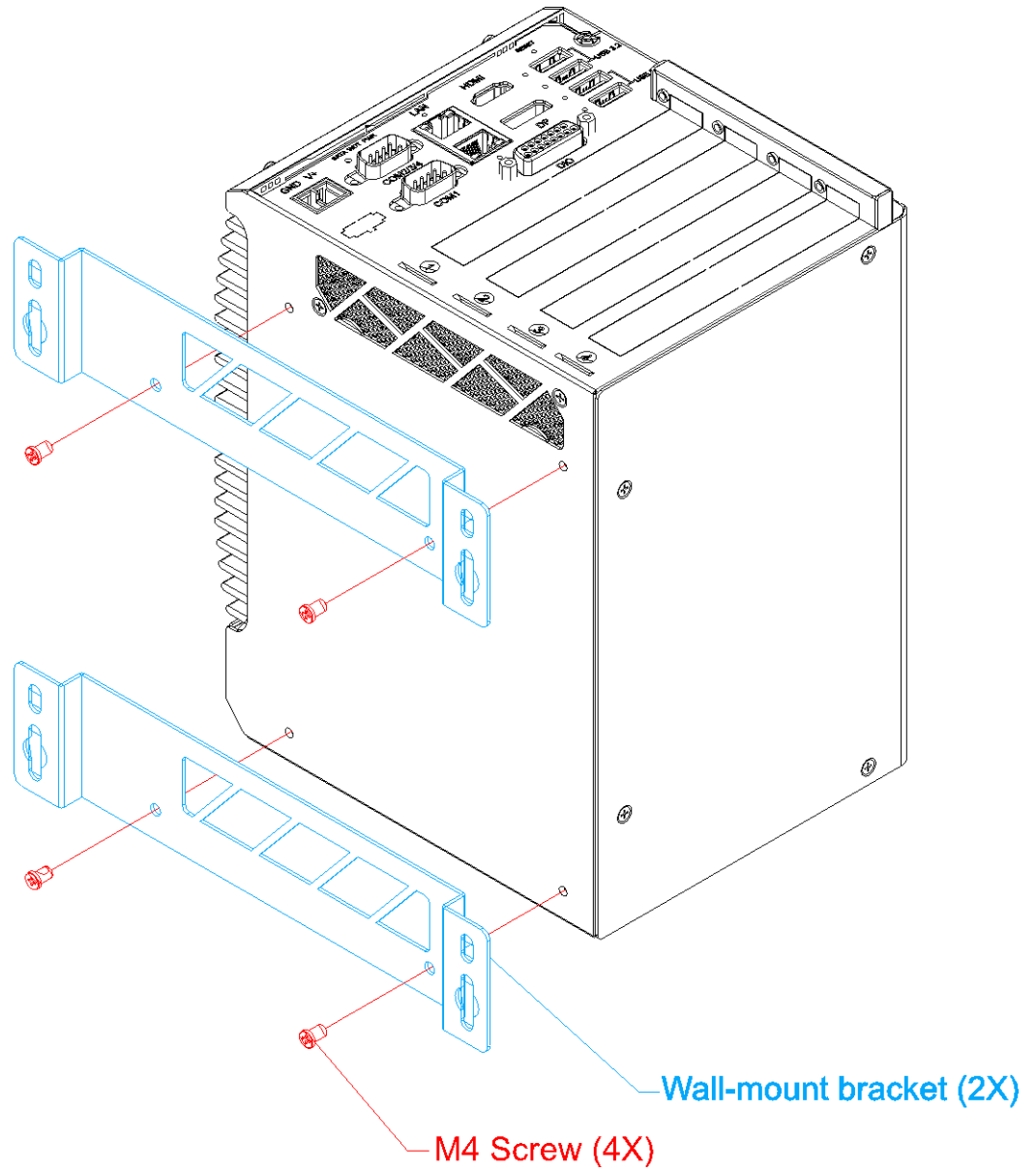

2. Place the system on a flat surface and secure it with screws.

3.5 Powering On the System

There are three methods to power on the system

- Pressing the power button
- Sending a LAN packet via Ethernet (Wake-on-LAN)

3.5.1 Powering On Using the Power Button

This is the simplest way to turn on your system. The power button is a non-latched switch and behaves as the ATX-mode on/off control. With DC power connected, pushing the power button will turn on the system and the PWR LED indicator will light up. Pushing the button when system is on will turn off the system. If your operating system supports ATX power mode (i.e. Microsoft Windows or Linux), pushing the power button while the system is in operation will result in a pre-defined system behavior, such as shutdown or hibernation.

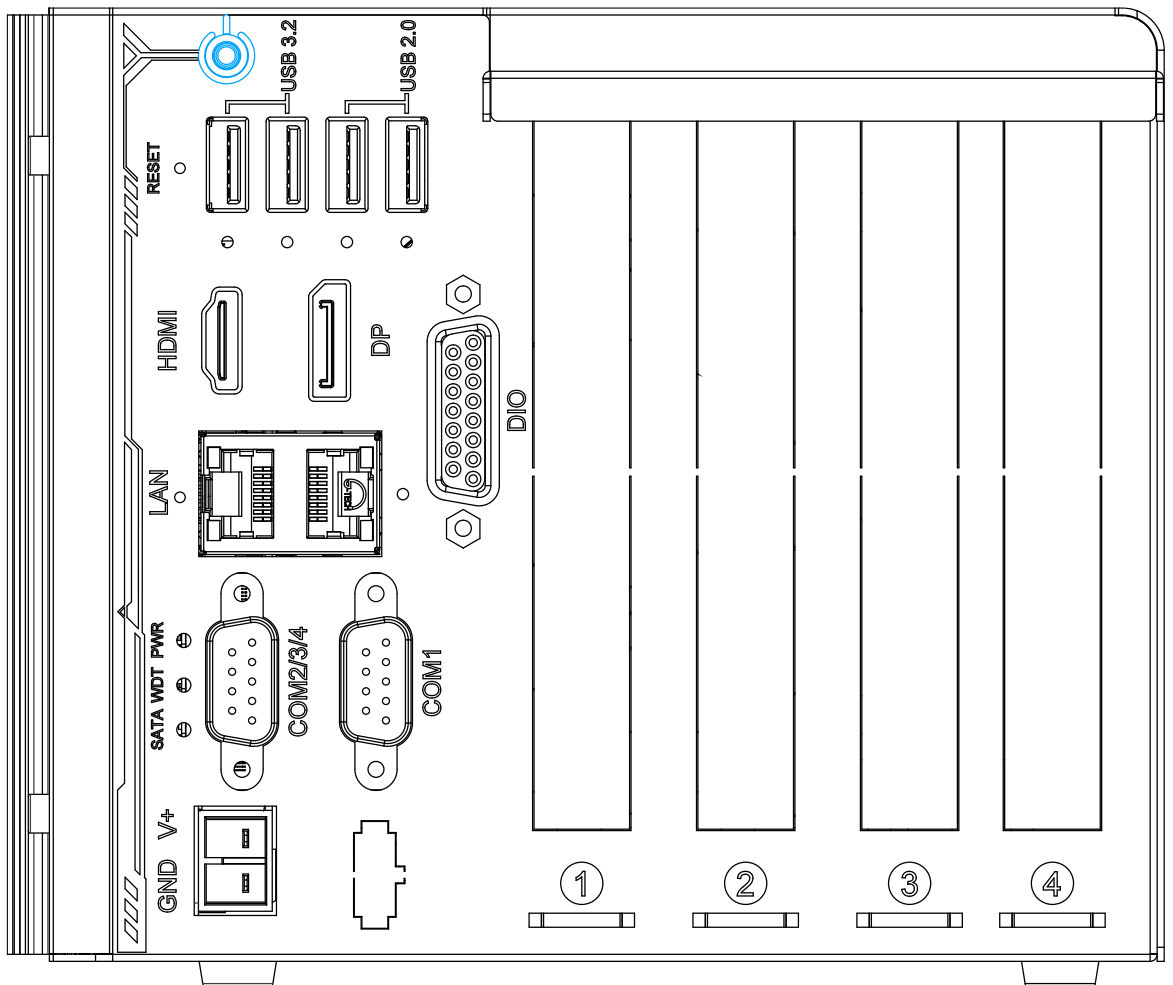

3.5.2 Powering On Using Wake-on-LAN

Wake-on-LAN (WOL) is a mechanism to wake up a computer system from a S5 (system off with standby power) state via issuing a magic packet. The system's Wake-on-LAN compatible GbE port is shown below.

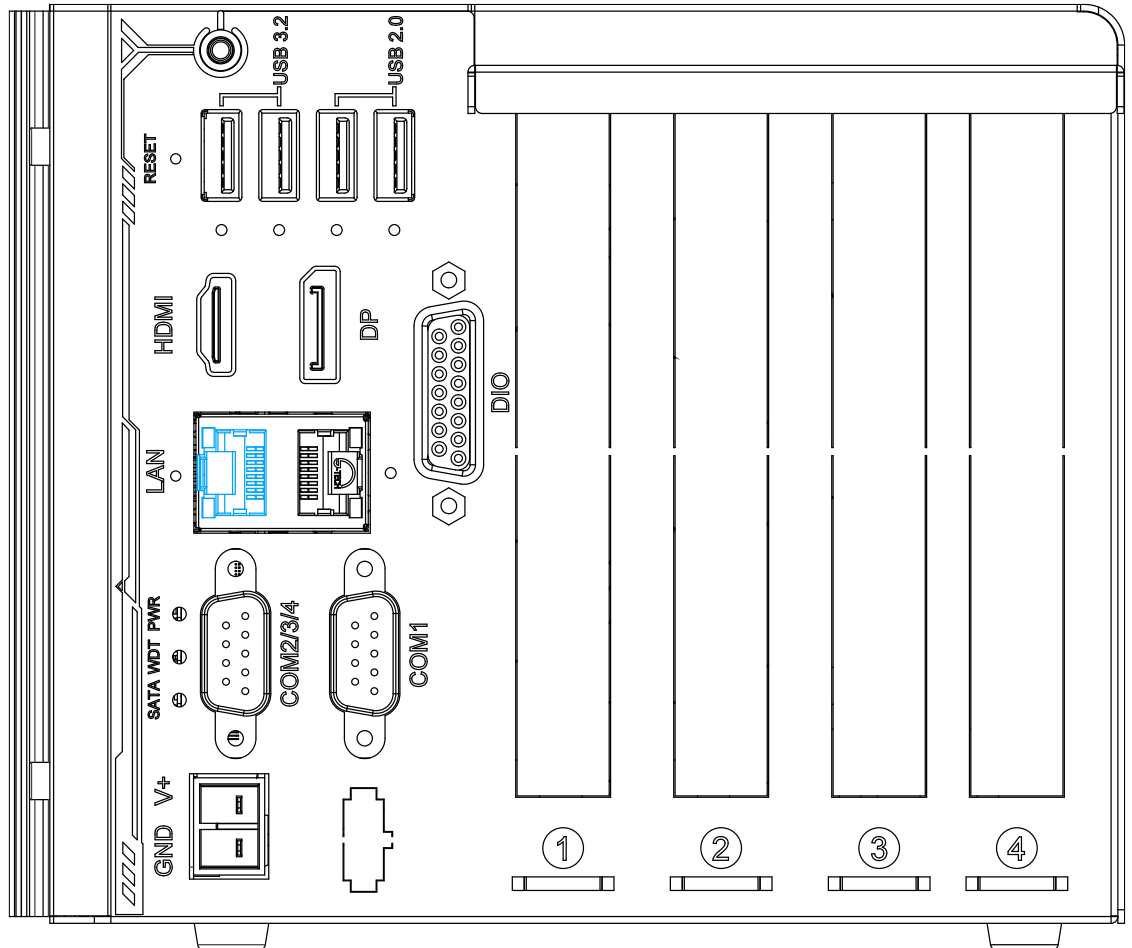

 **NOTE**

Please ensure that the “Power Saving Mode” in the BIOS has been Disabled.

Please make sure the Intel chipset and Ethernet driver has been properly installed prior to setting up WOL function.

To enable WOL function, please set up WOL settings in the BIOS and in the operating system by follow the steps described below.

1. When the system boots up, press F2 to enter BIOS setup utility.
2. Go to the **[Power]>[Wake On LAN]** and set it to **[Enabled]**.
3. Press F10 to “**Save changes and exit BIOS**” and allow the system boot into the operating system.

4. Once booted into the Windows system, press “**Windows key + E**”, right-click on “**Network>Properties>Change adapter settings**”. Locate and double-click on the adapter Intel® I219 Gigabit Network Connection, click on **Configure...**
5. Click on the **Power Management** tab and check the following options. Click on OK when done.

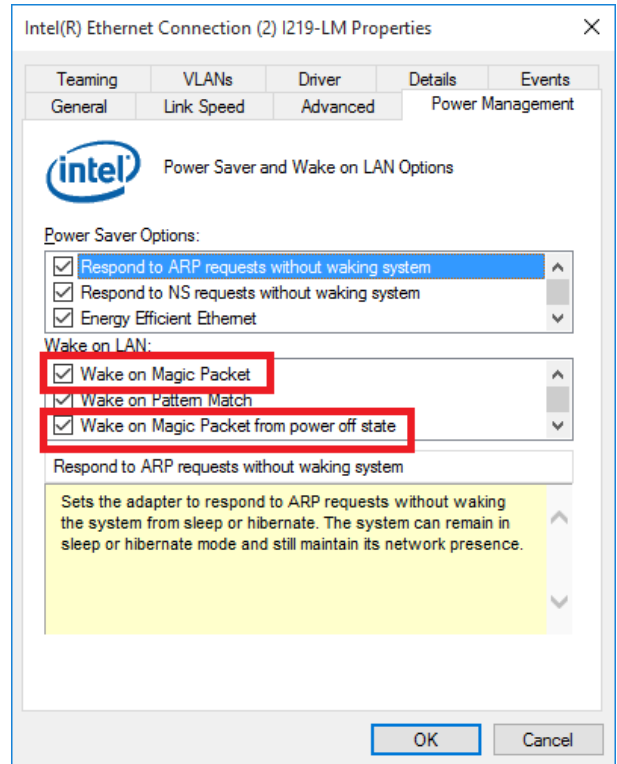

Magic Packet

The magic packet is a broadcast frame containing anywhere within its payload 6 bytes of all 255 (FF FF FF

FF FF FF in hexadecimal), followed by sixteen repetitions of the target computer's 48-bit MAC address.

For example, NIC's 48-bit MAC

Address is 78h D0h 04h 0Ah 0Bh 0Ch

DESTINATION SOURCE MISC

FF FF FF FF FF FF

78 D0 04 0A 0B 0C 78 D0 04 0A 0B 0C

78 D0 04 0A 0B 0C 78 D0 04 0A 0B 0C

78 D0 04 0A 0B 0C 78 D0 04 0A 0B 0C

78 D0 04 0A 0B 0C 78 D0 04 0A 0B 0C

78 D0 04 0A 0B 0C 78 D0 04 0A 0B 0C

78 D0 04 0A 0B 0C 78 D0 04 0A 0B 0C

78 D0 04 0A 0B 0C 78 D0 04 0A 0B 0C

78 D0 04 0A 0B 0C 78 D0 04 0A 0B 0C

MISC CRC

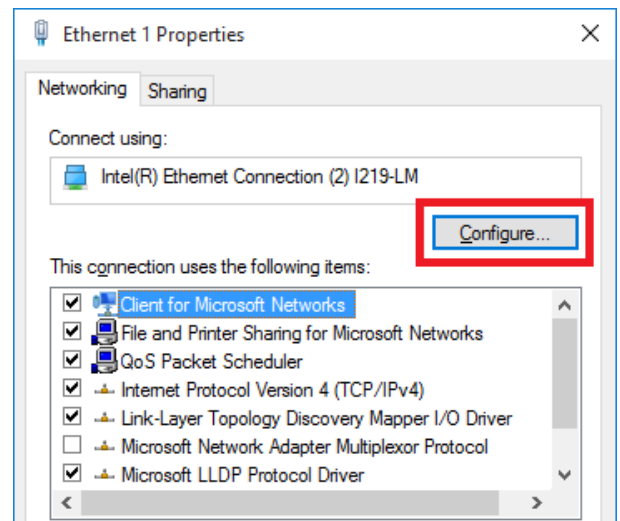

There are some free tools available on Internet that can be used to send a magic packet.

Please refer to the following link to understand more about [Magic Packet](#).

3.5.3 Configure your Windows system

When applying ignition power control to your system, please make sure you've configured your Windows system to initiate a shutdown process when pressing the power button. By default, Windows 10 goes to sleep (S3) mode when power button is pressed. As sleep (S3) is not a complete shutdown behavior, the ignition control function does not recognize the finish of a normal shut down process and thus users will encounter a system hard-off (power cut-off after 10 minutes). Please configure "When I press the power button" to "Shut down" in your Windows system settings.

Power button settings

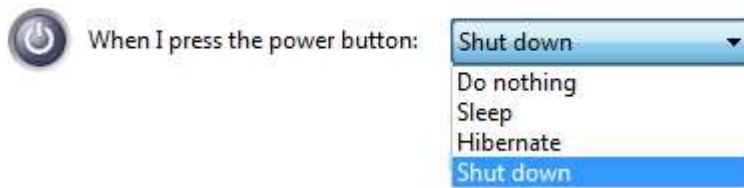

4 System Configuration

4.1 BIOS Settings

The system is shipped with factory-default BIOS settings meticulously programmed for optimum performance and compatibility. In this section, we'll illustrate some of BIOS settings you may need to modify. Please always make sure you understand the effect of change before you proceed with any modification. If you are unsure of the function you are changing, it is recommended to change one setting at a time to see its effect(s).

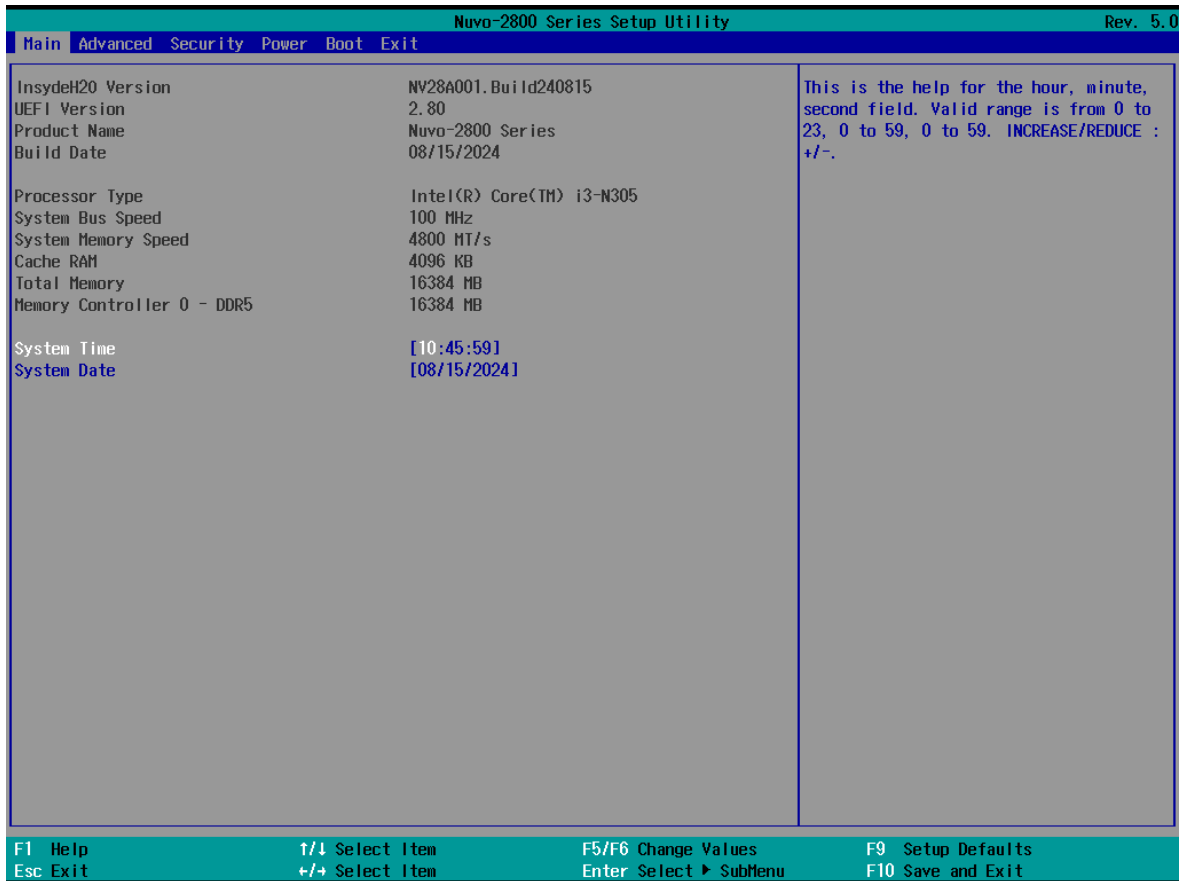

 **NOTE**

Not all BIOS settings will be discussed in this section. If a particular setting/ function you are after requires specific BIOS settings but is not discussed in this section, please contact Neosys Technical Support staff.

4.1.1 COM Port Configuration

The system's [COM1](#) port supports RS-232 (full-duplex), RS-422 (full-duplex) and RS-485 (half-duplex) mode. You can set the COM1 operating mode via BIOS settings. Another option in BIOS called “*Slew Rate*” defines how sharp the rising/falling edge is for the output signal of COM1. For long-distance RS-422/ 485 transmission, you may set the “*Slew Rate*” option as “High” to improve signal quality. For RS-422/ 485 communication, the “*RS-422/ 485 Termination*” option determines whether to enable/disable internal termination of RS-422/ 485 transceiver according to your wiring configuration (e.g. with or without external termination).

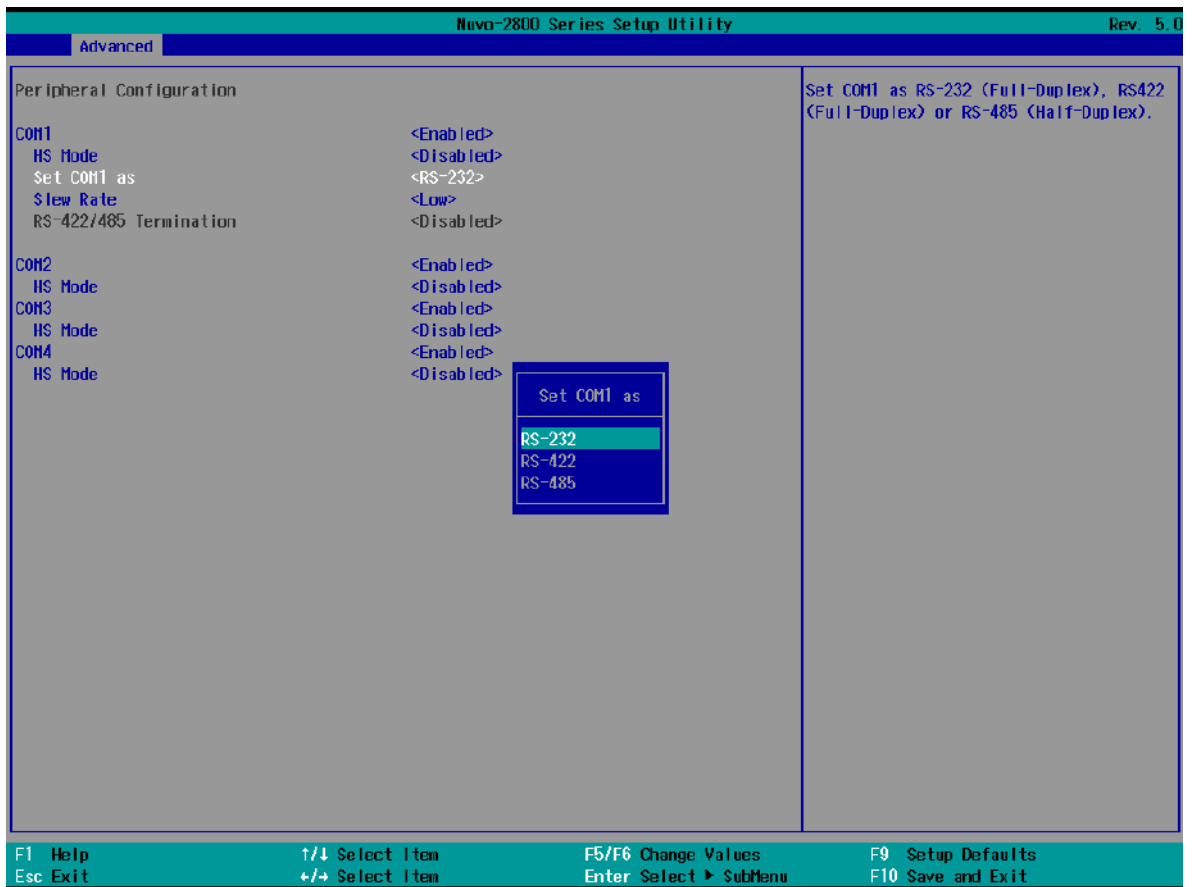

To set COM port operating mode:

1. Press **F2** when the system boots up to enter the BIOS setup utility.
2. Go to **[Advanced]** → **[Peripheral Configuration]**.
3. Set the **[Set COM1 Mode as]** option to the desired mode.
4. Once set, press **F10** to save setting and exit.

4.1.2 COM Port High Speed Mode

The high speed mode of each COM port effectively allows for the port's baud rate generator to operate at 8x the speed with an effective baud rate of 921,600 bps (115,200 x 8). Please refer to the following instructions on how to enable the high speed mode for your COM port (COM1 used as an example).

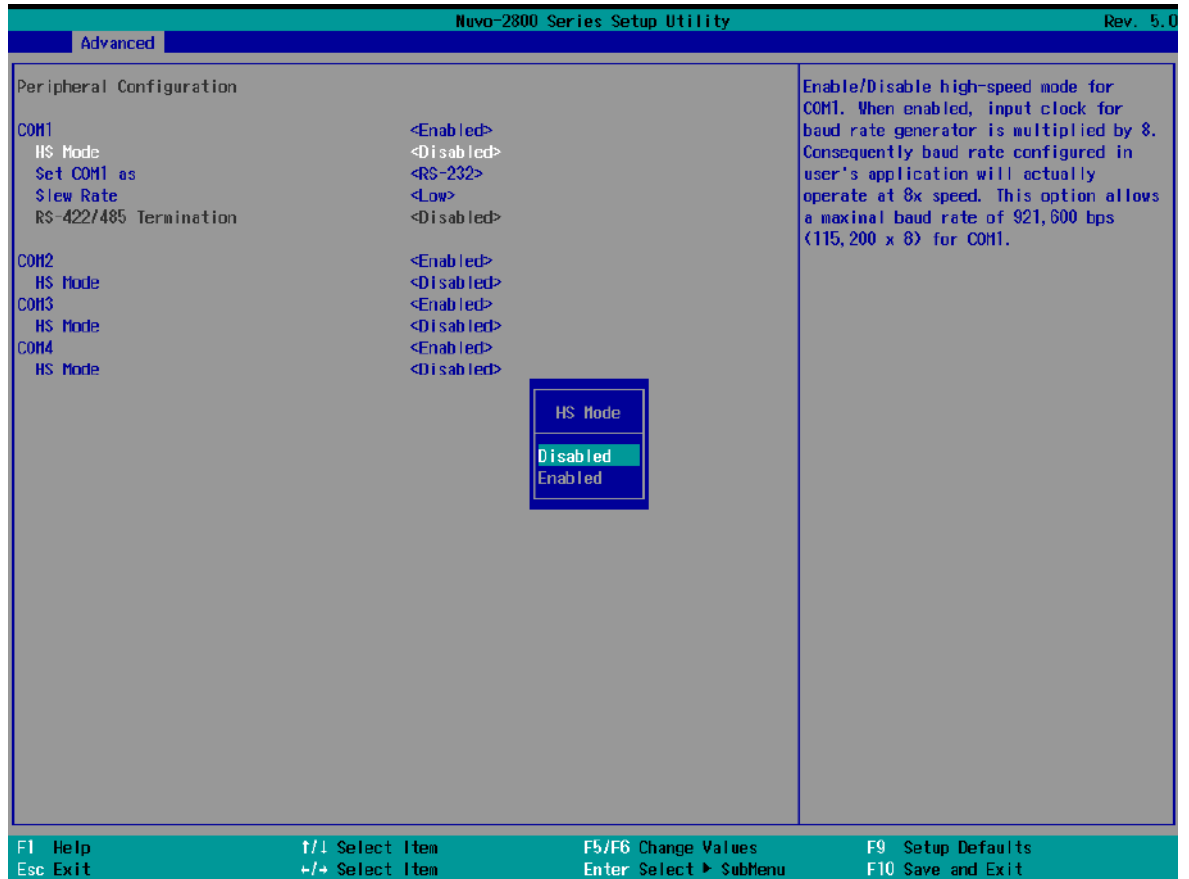

To set COM port high speed mode:

1. Press **F2** when the system boots up to enter the BIOS setup utility.
2. Go to **[Advanced] > [Peripheral Configuration]**.
3. Enable or set the **[Set COM1 Mode as]** option to the desired mode.
4. Highlight **[HS Mode]** and press ENTER to bring up options, highlight **[Enable]** and press ENTER.
5. Once set, press **F10** to save setting and exit.

4.1.3 Init Delay Before PCIe Reset

This setting offers delay in milliseconds before the PCIe signal is reset. By increasing this value, you can extend the time between PCIe card power-on and PCIe reset.

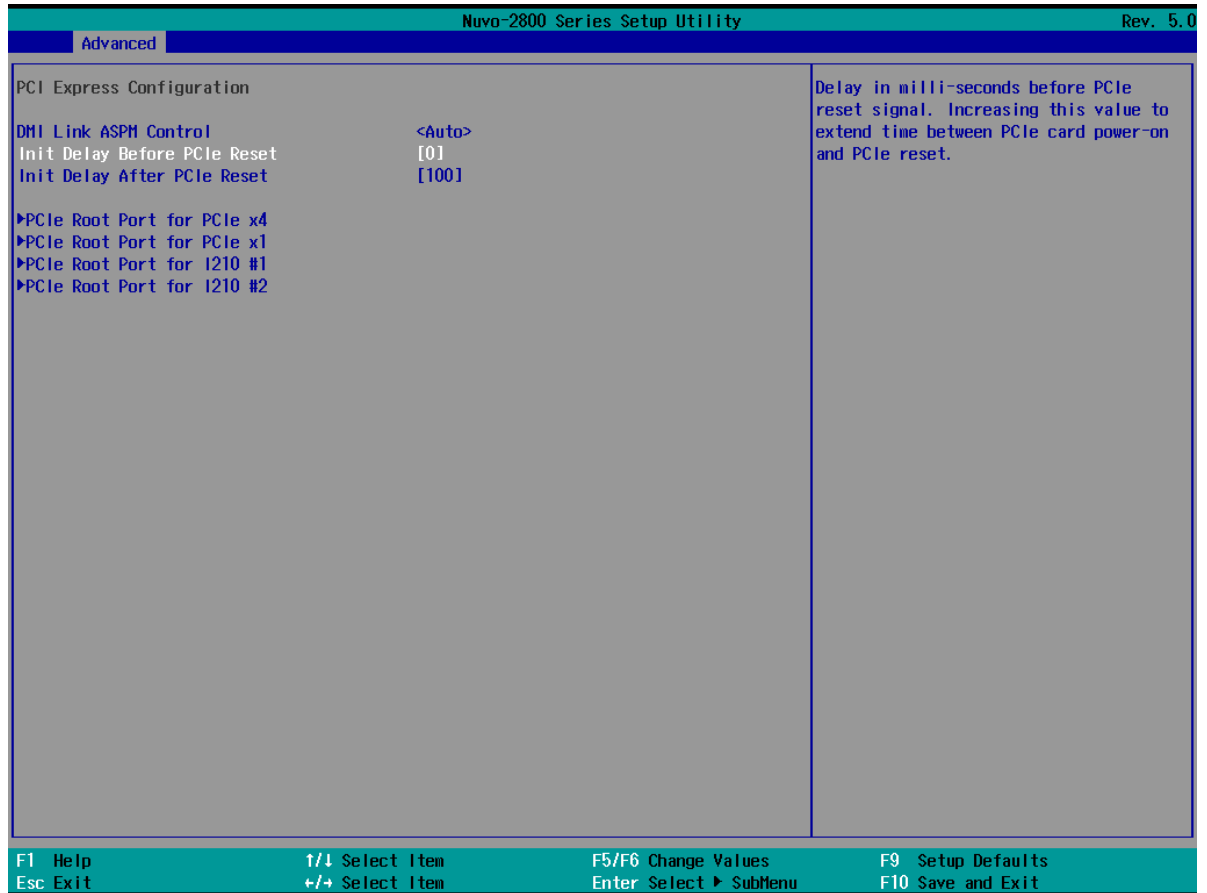

To set Init delay in milliseconds:

1. When system boots up, press F2 to enter BIOS setup utility.
2. Go to **[Advanced] > [PCI Express Configuration] > [Init Delay Before PCIe Reset]** and press ENTER.
3. A small window will appear for you to enter the desired delay values.
4. When done, press F10 to “Exit Saving Changes”

4.1.4 Power On After Power Failure Option

This option defines the behavior of System series when DC power is supplied.

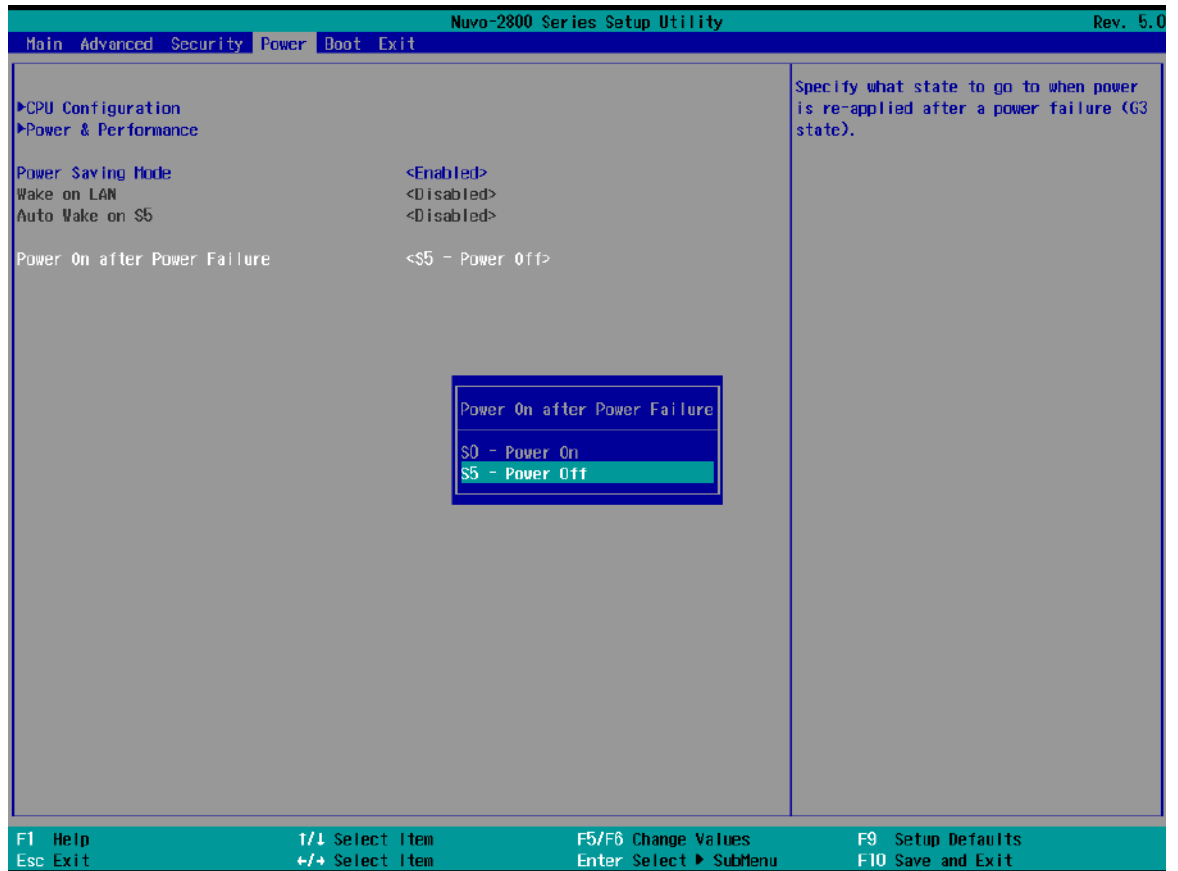

Value	Description
S0 – Power On	System is powered on when DC power is supplied.
S5 – Power Off	System is kept in off state when DC power is supplied.

To set “Power On after Power Failure” option:

1. When system boots up, press F2 to enter BIOS setup utility.
2. Go to **[Power] > [Power On after Power Failure]**.
3. Scroll down to highlight **[Power On after Power Failure]**, press ENTER to bring up setting options, S0 – Power On or S5 – Power Off, and press ENTER to select the setting.
4. Press F10 to “Exit Saving Changes”.

4.1.5 Power & Performance

The system supports Intel Alder Lake N97 CPU with a 12W TDP. The platform offers a boot performance mode to maximize efficiency (Max Battery) or performance (Turbo Performance).

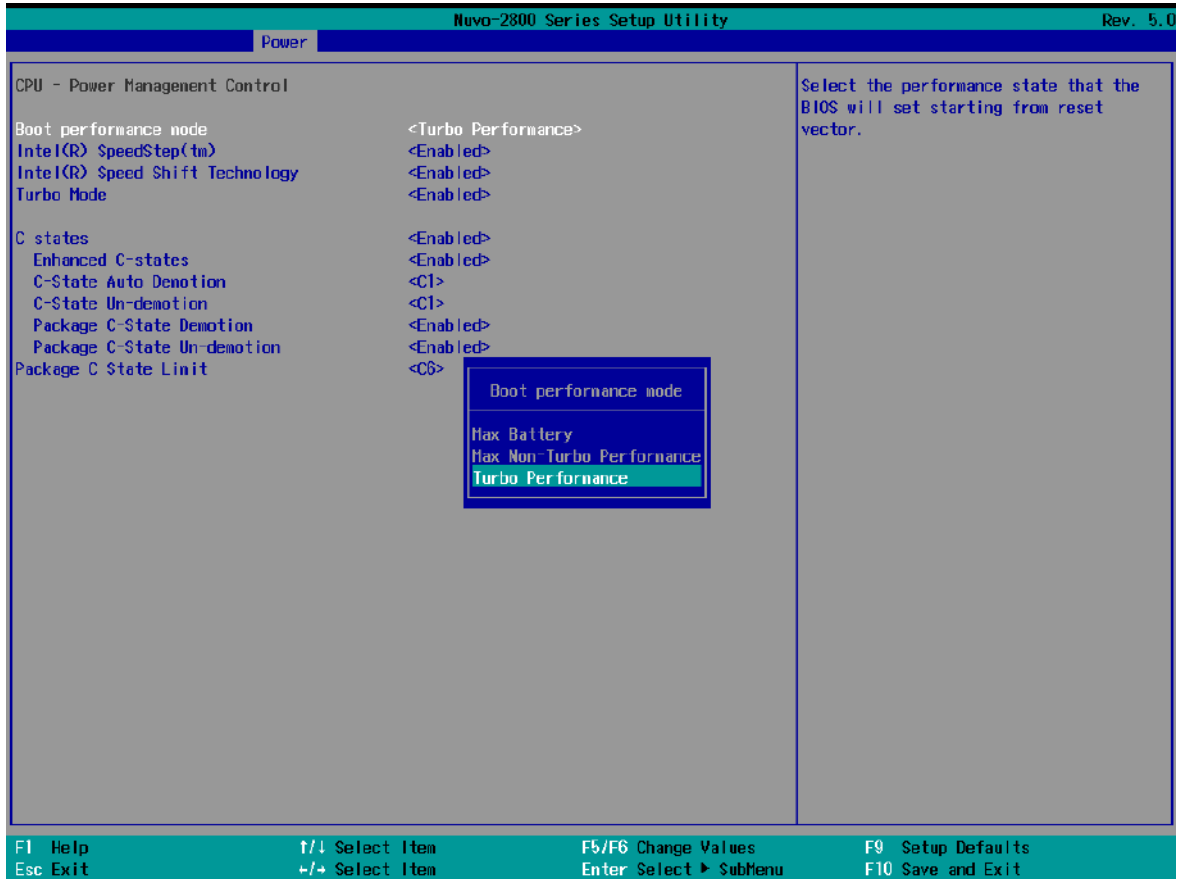

To configure the CPU SKU power limit:

1. When the system boots up, press F2 to enter BIOS setup utility.
2. Go to **[Power]** → **[Power & Performance]** → **[Boot performance mode]**.
3. Select a desired value, and press ENTER to select it.
4. Press F10 to “Exit Saving Changes”.



NOTE

The option "Turbo Performance" allows the CPU to operate at maximum performance with the highest power consumption. Make sure you're using a power supply with a rated power output four times that of the CPU TDP to ensure reliable system operations.

4.1.6 Power Saving Mode

 **NOTE**

*If you are using WOL functions, please set Power Saving Mode to **Disabled**.*

The platform features a power saving mode where when in idle, the system consumes approximately 1.1V of electricity.

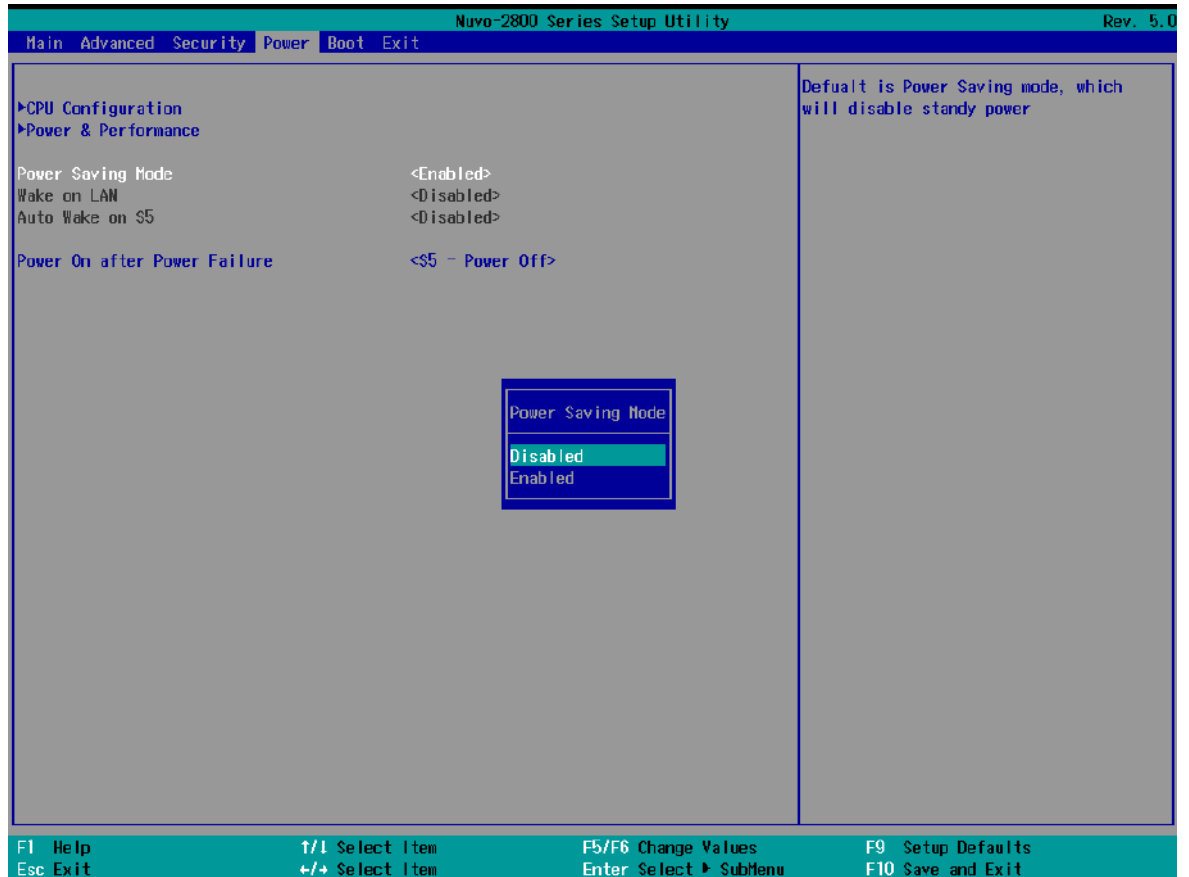

To enable the power saving mode:

1. When the system boots up, press F2 to enter BIOS setup utility.
2. Go to **[Power]** → **[Power Saving Mode]**, and press ENTER.
3. Select Enabled or Disabled, and press ENTER to set it.
4. Press F10 to save and exit.

4.1.7 Wake on LAN Option

 **NOTE**

Please set Power Saving Mode to **Disabled** if you are using WOL functions.

Wake-on-LAN (WOL) is a mechanism which allows you to turn on your System series via Ethernet connection. To utilize Wake-on-LAN function, you have to enable this option first in BIOS settings. Please refer "[Powering On Using Wake-on-LAN](#)" to set up the system.



To enable/ disable “Wake on LAN” option:

1. When system boots up, press F2 to enter BIOS setup utility.
2. Go to **[Power]> [Wake on LAN]**.
3. Press ENTER to bring up setting options, scroll to the setting you desire and press ENTER to set.
4. Press F10 to “Exit Saving Changes.

4.1.8 Boot Menu

The Boot menu in BIOS allows you to specify the system’s boot characteristics by setting bootable device components (boot media) and method. Or, you may press F12 upon system start up and select a device you wish boot from.

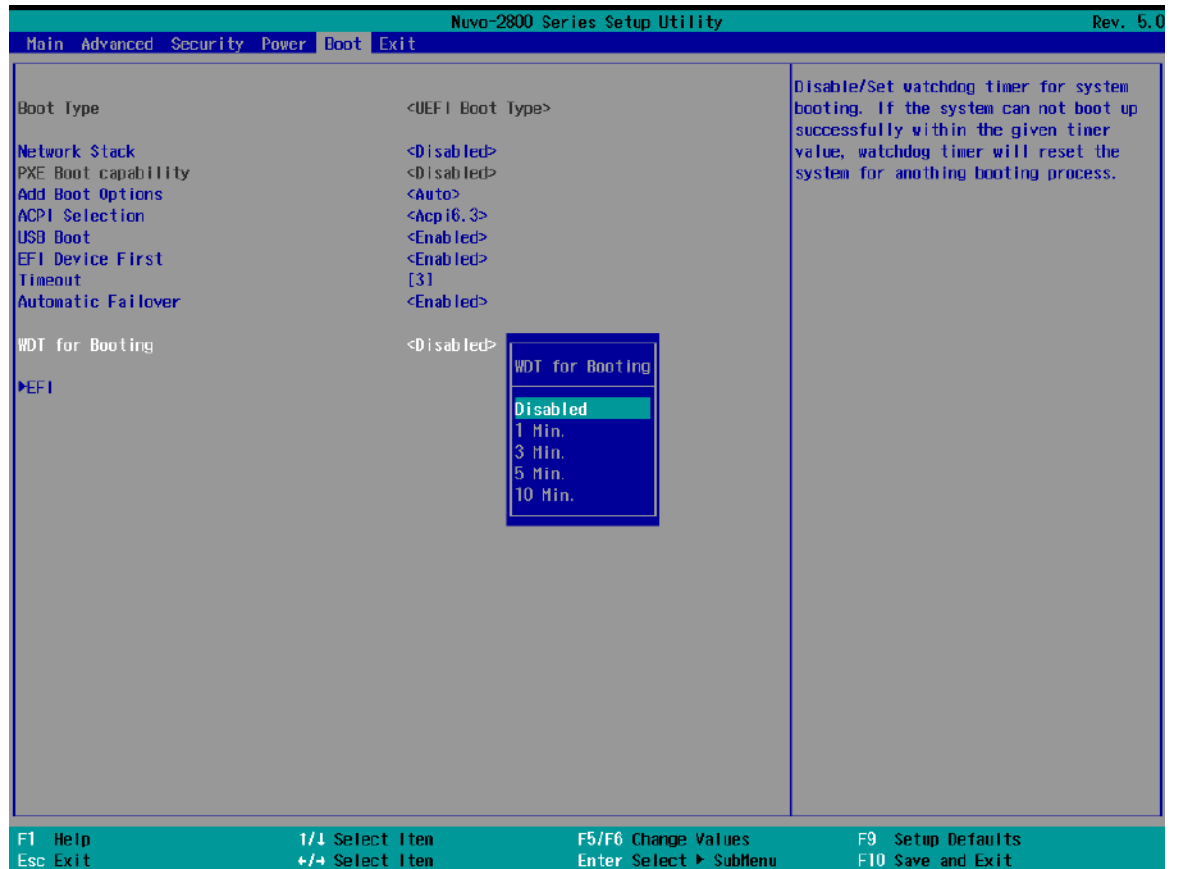

Value	Option	Description
Boot Type	UEFI Boot Type	Only legacy boot media listed are approved as boot media.
Network Stack	Enabled	The system is available for network access using UEFI.
	Disabled	The system is not available for network access using UEFI.
PXE Boot capability	Disabled	Only UEFI Network Stack is supported: Preboot eXecution Environment (PXE) is not supported
	Enabled	By enabling the PXE boot, one can choose to boot via I210 Only .
Add Boot Options	First	Newly detected boot media are placed at the top of the boot order.

	Last	Newly detected boot media are placed at the bottom of the boot order.
ACPI Selection	1.0B/ 3.0/ 4.0/ 5.0/ 6.0	Advanced Configuration and Power Interface allows the operating system to control system power management
USB Boot	Enabled	Allow boot from bootable USB devices.
	Disabled	Does not allow boot from bootable USB devices
EFI Device First	Enabled	Set to boot bootable EFI media first.
	Disabled	Will not boot bootable EFI media first.
Timeout	1, 2, 3, etc (in seconds)	Boot delay time in seconds to give the user time to activate the hotkey to access the BIOS
WDT for booting	Disabled, 1, 3, 5, 10 (minutes)	WDT ensures a successful system boot by specifying a timeout value

4.1.9 Position New Boot Device

The “Add Boot Options” allow you to determine whether a newly added device (eg. USB flash disk) is to boot as the first device to boot or the last in the boot sequence.

To set the newly-installed boot device as the first or last boot device:

1. Press **F2** when the system boots up to enter the BIOS setup utility.
2. Go to **[Boot] > [Add Boot Options]** menu.
3. Select **[First]** or **[Last]** for your newly-added boot device and press ENTER.

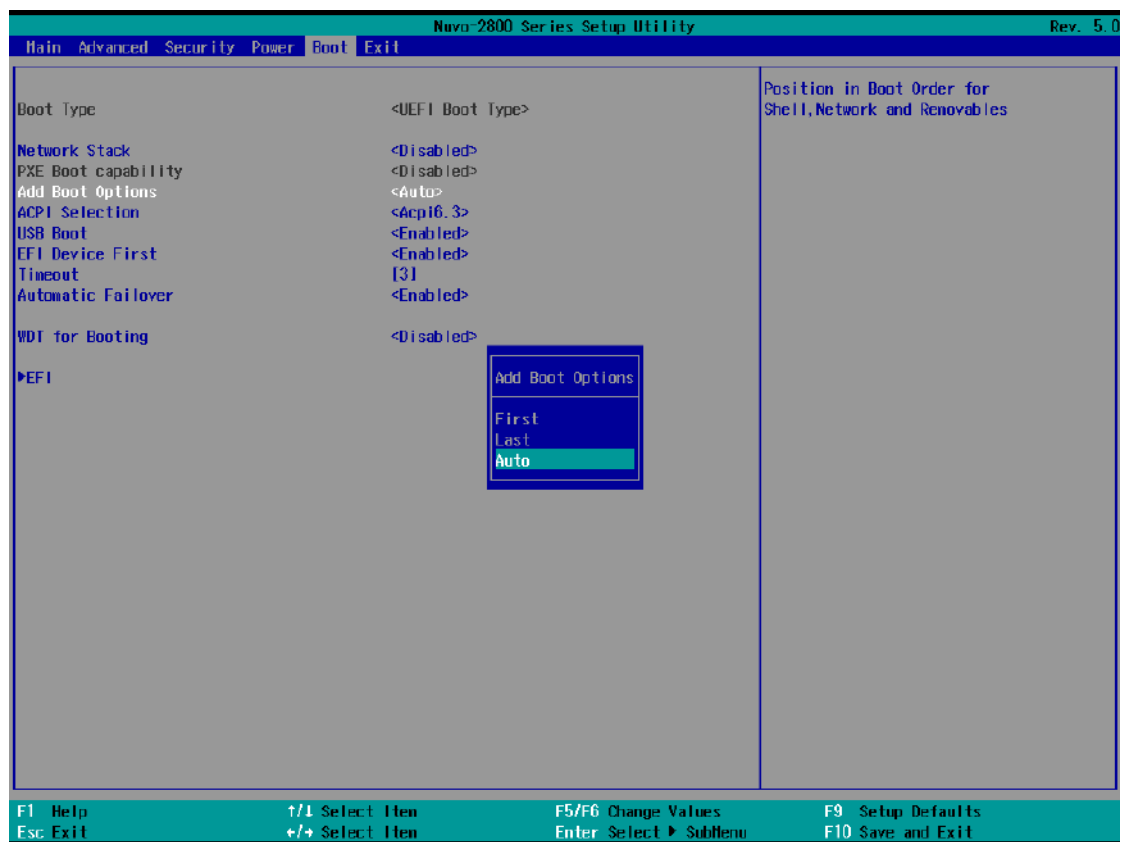

4. Once set, press **F10** to save setting and exit.

4.1.10 Watchdog Timer for Booting

The watchdog timer secures the boot process by means of a timer. Once the timer expires, a reset command is issued to initiate another booting process. There are two options in BIOS menu, “*Automatically after POST*” and “*Manually after Entering OS*”. When “*Automatically after POST*” is selected, the BIOS automatically stops the watchdog timer after POST (Power-On Self Test) OK. When “*Manually after Entering OS*” is selected, the user must stop the watchdog timer once booted into the OS. This guarantees the system can always boot into the OS, otherwise another booting process will be initiated. For information about programming watchdog timer, please refer to [Watchdog Timer & Isolated DIO](#).

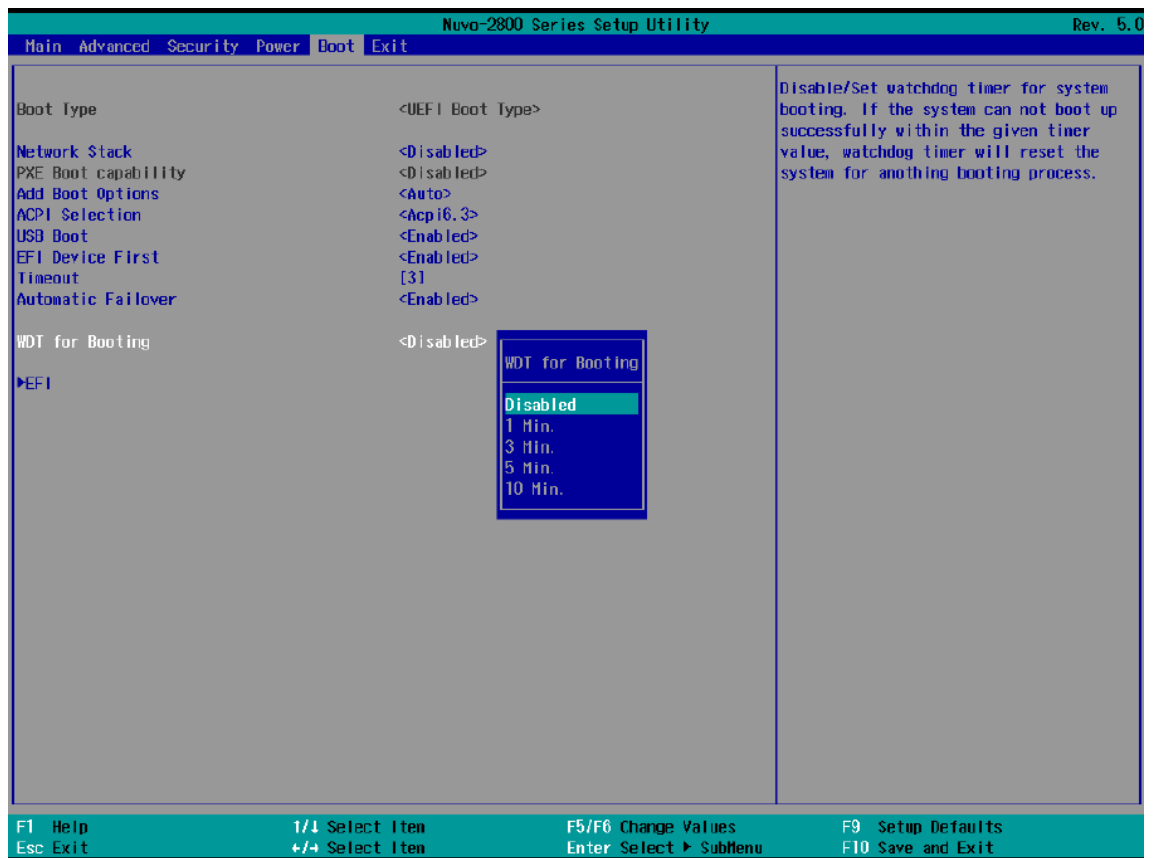

To set the watchdog timer for boot in BIOS:

1. When system boots up, press F2 to enter BIOS setup utility.
2. Go to **[Boot]** menu.
3. Disable or select timeout value for **[WDT for Booting]** option.
4. Once you give a timeout value, the **[WDT Stop Option]** option appears. You can select “*Automatically after POST*” or “*Manually after Entering OS*”.
5. Press F10 to “Exit Saving Changes”.

5 OS Support and Driver Installation

5.1 Operating System Compatibility

The system supports most operating system developed for Intel® x86 architecture. The following list contains the operating systems which have been tested by Neosys Technology.

- Microsoft Windows 10 LTSC 2021 (x64)
- Microsoft Windows 11 IoT Enterprise 22H2 64-bit
- Ubuntu 20.04.2 LTS or other distribution with kernel version ≥ 5.19 */**



NOTE

**For Linux system, user may need to manually compile and install the driver for Intel graphics or I210 GbE controller if the driver is not embedded in kernel. You can visit Intel website for further information.*

***For distributions, graphics driver function may not be completely implemented in its kernel. You may encounter restrictions when using these features, such as dual independent display. For optimum operation, it is the users' responsibility to manually check for new drivers and upgrades!*

Neosys may remove or update operating system compatibility without prior notice. Please contact us if your operating system of choice is not on the list.

5.2 Driver Installation

The system drivers are available online, please click on this link to download the driver.

5.3 Drivers Installation for Watchdog Timer Control

Neosys provides a driver package which contain function APIs for Watchdog Timer control function. You should install the driver package (WDT_DIO_Setup.exe) in prior to use these functions. Please note that you must install WDT_DIO_Setup_v2.4.0.0 or later versions.

Please refer to this [link](#) to download WDT_DIO.

Appendix A Using WDT & DIO

The watchdog timer (WDT) function ensures reliable system operation. The WDT is a hardware mechanism to reset the system if the watchdog timer is expired. Users can start the WDT and keep resetting the timer to make sure the system or program is running. Otherwise, the system shall be reset.

In this section, we'll illustrate how to use the function library provided by Neosys to program the WDT functions. Currently, WDT driver library supports Windows 10 x64 and WOW64 platform. For other OS support, please contact Neosys Technology for further information.

Installing WDT_DIO Library

The WDT_DIO function library is delivered in the form of a setup package named **WDT_DIO_Setup.exe**. In prior to program WDT, you should execute the setup program and install the WDT library. Please use the following WDT_DIO_Setup packages according to your operating systems and application.



NOTE

Please download from Neosys website and install the latest WDT_DIO_Setup.exe file.

WDT and DIO Library Installation

To WDT_DIO_Setup.2.4.0.0.exe will be used as an example to demonstrate WDT & DIO Library installation setup process. Please refer to the instructions below.

1. Execute **WDT_DIO_Setup.2.4.0.0.exe**.

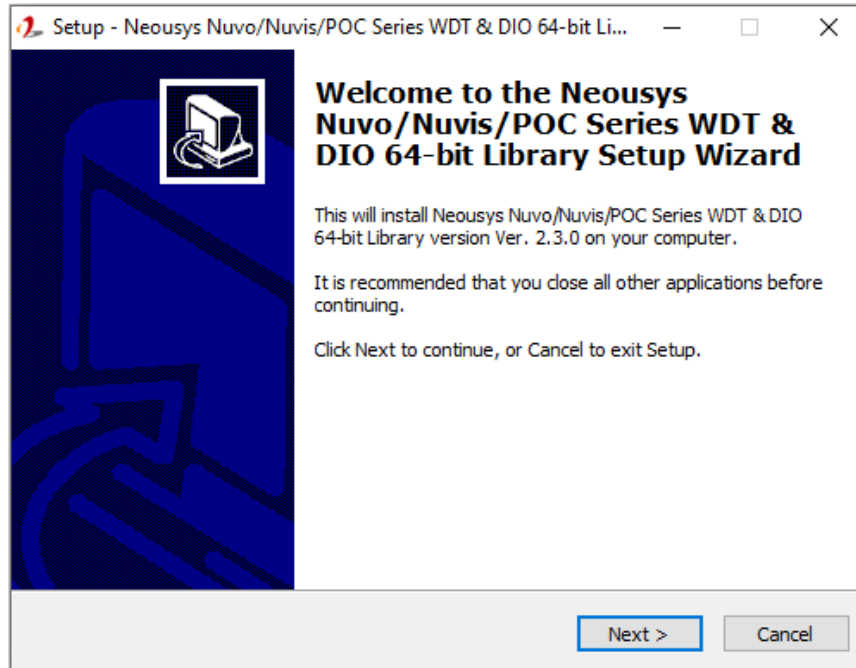

2. Click "Next >" and specify the directory of installing related files. The default directory is *C:\Neosys\WDT_DIO*.

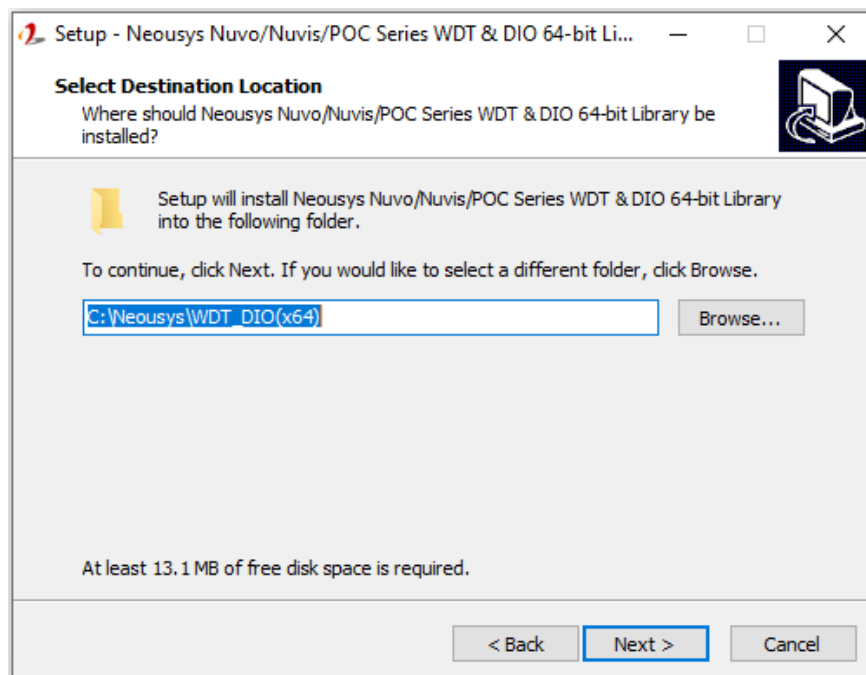

- Once the installation has finished, a dialog will appear to prompt you to reboot the system. The WDT & DIO library will take effect after the system has rebooted.

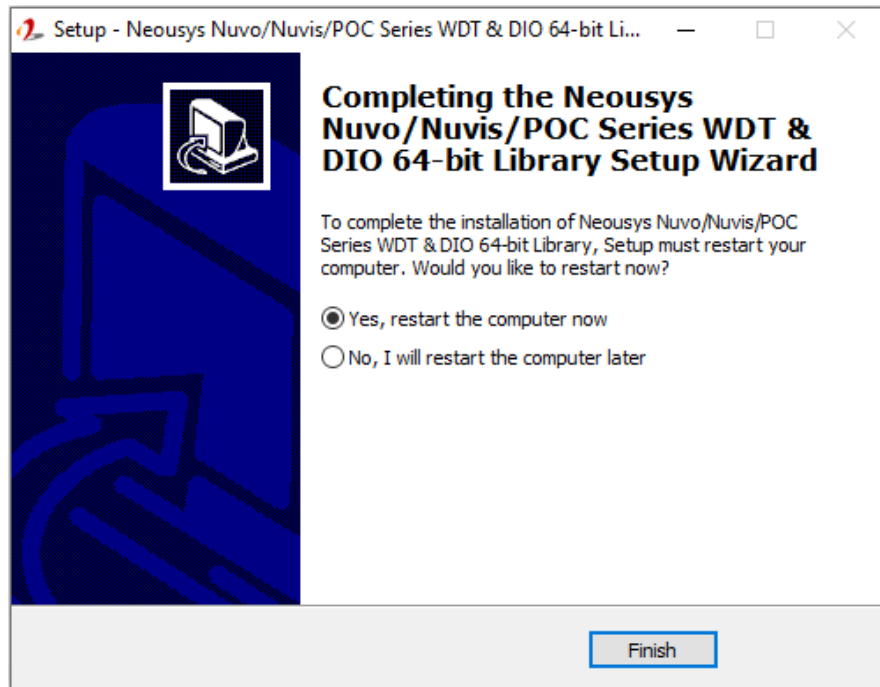

- When programming your WDT or DIO program, the related files are located in

Header File:	\Include
Library File:	\Lib
Function Reference:	\Manual
Sample Code:	\Sample\WDT_Demo (Demo for Watchdog Timer) \Sample\DIO_Demo (Demo for isolated DIO Control) \Sample\COS_Demo (Demo for change-of-state DI)

WDT Function Reference

InitWDT

Syntax	BOOL InitWDT(void);
Description:	Initialize the WDT function. You should always invoke InitWDT() before set or start watchdog timer.
Parameter	None
Return Value	TRUE: Successfully initialized FALSE: Failed to initialize
Usage	BOOL bRet = InitWDT();

SetWDT

Syntax	BOOL SetWDT(WORD tick, BYTE unit);
Description	Set timeout value and unit for watchdog timer. When InitWDT() is invoked, a default timeout value of 255 seconds is assigned.
Parameter	<i>tick</i> WORD value (1 ~ 65535) to indicate timeout ticks. <i>unit</i> BYTE value (0 or 1) to indicate unit of timeout ticks. 0 : unit is minute 1: unit is second
Return Value	If value of unit is correct (0 or 1), this function returns TRUE, otherwise FALSE.
Usage	WORD tick=255; BYTE unit=1; //unit is second. BOOL bRet = SetWDT(tick, unit); //timeout value is 255 seconds

StartWDT

Syntax	BOOL StartWDT(void);
Description	Starts WDT countdown. Once started, the WDT LED indicator will begin blinking. If ResetWDT() or StopWDT is not invoked before WDT countdowns to 0, the WDT expires and the system resets.
Parameter	None
Return Value	If the timeout value is given in correct format (WDT started), this function returns TRUE, otherwise FALSE
Usage	BOOL bRet = StartWDT()

ResetWDT

Syntax	BOOL ResetWDT(void);
Description	Reset the timeout value to the value given by SetWDT().If ResetWDT() or StopWDT is not invoked before WDT countdowns to 0, the WDT expires and the system resets.
Parameter	None
Return Value	Always returns TRUE
Usage	BOOL bRet = ResetWDT()

StopWDT

Syntax	BOOL StopWDT(void);
Description	Stops the countdown of WDT. When WDT has stopped, the WDT LED indicator stops blinking.
Parameter	None
Return Value	Always returns TRUE
Usage	BOOL bRet = StopWDT()

DIO Functions

InitDIO

Syntax	BOOL InitDIO(void);
Description	Initialize the DIO function. You should always invoke InitDIO() before write/read any DIO port/channel.
Parameter	None
Return Value	Returns TRUE if initialization successes, FALSE if initialization failed.
Usage	BOOL bRet = InitWDT()

DIReadLine

Syntax	BOOL DIReadLine(BYTE ch);
Description	Read a single channel of isolated digital input.
Parameter	ch BYTE value specifies the DI channel to be read. <i>Ch</i> should be a value of 0 ~ 7.
Return Value	The status (TRUE or FALSE) of the specified DI channel.
Usage	BYTE ch=3; //DI channel #3 BOOL DIChValue = DIReadLine(ch); //read DI channel #3

DIReadPort

Syntax	WORD DIReadPort(void);
Description	Read the entire isolated digital input port (8 channels).
Parameter	None
Return Value	A WORD value (0~255) indicates the status of DI port (8 DI channels).
Usage	WORD DIPortValue = DIReadPort ();

DOWriteLine

Syntax	void DOWriteLine(BYTE ch, BOOL value);
Description	Write a single channel of isolated digital output.
Parameter	<p>ch BYTE value specifies the DO channel to be written. <i>Ch</i> should be a value of 0 ~ 7.</p> <p>value BOOL value (TRUE or FALSE) specifies the status of DO channel.</p>
Return Value	None
Usage	<pre> BYTE ch=3; //DI channel #3 BOOL DOChValue=TRUE; DOWriteLine(ch, DOChValue); //write DO channel #3 as TRUE </pre>

DOWritePort

Syntax	void DOWritePort(WORD value);
Description	Write the entire isolated digital output port (8 channels).
Parameter	<p>value WORD value specifies the status of the DO port. <i>Value</i> should be a value of 0~255.</p>
Return Value	None
Usage	<pre> WORD DOPortValue=0XFF; //11111111b DOWritePort(DOPortValue); //write DO port as 11111111b </pre>