

# **Neosys Technology Inc.**

**Nuvo-9000VTC Series**

## **User Manual**

Revision 1.2

# Table of Contents

Table of Contents .....	2
Legal Information .....	5
Contact Information .....	6
Declaration of Conformity .....	6
Copyright Notice .....	7
Safety Precautions .....	8
Hot Surface Warning .....	8
Battery Warning .....	8
Service and Maintenance .....	9
ESD Precautions .....	9
Restricted Access Location .....	9
About This Manual .....	10
<b>1 Introduction</b>	
<b>1.1 Nuvo-9100VTC Series Specifications .....</b>	<b>12</b>
1.1.1 Nuvo-9100VTC Specifications .....	12
1.1.2 Nuvo-9104VTC Specifications .....	15
1.1.3 Nuvo-9108VTC Specifications .....	18
<b>1.2 Nuvo-9200VTC Series Specifications .....</b>	<b>21</b>
1.2.1 Nuvo-9200VTC Specifications .....	21
1.2.2 Nuvo-9204VTC Specifications .....	24
1.2.3 Nuvo-9208VTC Specifications .....	27
<b>1.3 Isolated DIO Specifications .....</b>	<b>30</b>
<b>1.4 Nuvo-9100VTC Series Dimension .....</b>	<b>31</b>
1.4.1 Nuvo-9100VTC Series Front Panel View .....	31
1.4.2 Nuvo-9100VTC Series Rear Panel View .....	31
1.4.3 Nuvo-9100VTC Series Top View .....	32
1.4.4 Nuvo-9100VTC Series Bottom View .....	33
1.4.5 Nuvo-9100VTC Series with Damping Bracket .....	33
<b>1.5 Nuvo-9200VTC Series Dimension .....</b>	<b>34</b>
1.5.1 Nuvo-9200VTC Series Front Panel View .....	34
1.5.2 Nuvo-9200VTC Series Rear Panel View .....	34
1.5.3 Nuvo-9200VTC Series Top View .....	35
1.5.4 Nuvo-9200VTC Series Bottom View .....	36
1.5.5 Nuvo-9200VTC Series with Damping Bracket .....	36
<b>2 System Overview</b>	
<b>2.1 Packing List .....</b>	<b>37</b>
2.1.1 Nuvo-9100VTC Series Packing List .....	37
2.1.2 Nuvo-9200VTC Series Packing List .....	37
<b>2.2 Nuvo-9000VTC Series Front Panel I/O .....</b>	<b>38</b>
2.2.1 USB3.2 Gen2x1 Port .....	40
2.2.2 USB2.0 Port .....	40
2.2.3 CMOS Reset Button .....	41
2.2.4 VGA Port .....	42
2.2.5 DVI Port .....	43
2.2.6 USB3.2 Gen1x1 Port .....	43
2.2.7 DisplayPort .....	44
2.2.8 USB3.2 Gen2x2 Type-C Port .....	45
2.2.9 2.5 Ethernet Port/ Optional PoE+ .....	46
2.2.10 Reset Button .....	47
2.2.11 LED Indicators .....	47
2.2.12 Power Button .....	48
2.2.13 Hot-swappable 2.5" HDD/ SSD Slot .....	48
2.2.14 Cassette Module .....	49
<b>2.3 Nuvo-9000VTC Series Rear Panel I/O .....</b>	<b>50</b>
2.3.1 CAN bus Port .....	52

2.3.2	M12 Power over Ethernet Port (Nuvo-9100/ 9200VTC).....	53
2.3.3	RJ45 Power over Ethernet Port (Nuvo-9104/ 9204/ 9108/ 9208TC) .....	54
2.3.4	Digital Input/ Output .....	55
2.3.5	COM Ports .....	57
2.3.6	3-Pin Terminal Block for DC and Ignition Input.....	58
2.3.7	3-Pin Remote On/ Off .....	58
<b>2.4</b>	<b>Internal I/O Functions.....</b>	<b>59</b>
2.4.1	Dual SODIMM DRAM Slot .....	59
2.4.2	Mini-PCIe Socket & Pin Definition.....	60
2.4.3	M.2 2242/ 3042/ 3052 (B Key), Mini-SIM Card Slot & Pin Definition.....	62
2.4.4	SATA Ports .....	64
2.4.5	DIP Switch .....	65
2.4.6	On/ Off Ctrl & Status Output.....	66
2.4.7	Internal USB 2.0 Port.....	67
2.4.8	M.2 2280 (M Key) Slot for NVMe SSD.....	68
2.4.9	M.2 Socket on MezIO™ Module .....	70
2.4.10	mini-PCIe Socket on MezIO™ Module.....	72
2.4.11	Ignition Control Rotary Switch on MezIO™ Module .....	74

### 3 System Installation

<b>3.1</b>	<b>Disassembling the System .....</b>	<b>76</b>
<b>3.2</b>	<b>Installing Internal Components.....</b>	<b>84</b>
3.2.1	CPU Installation for Barebone System.....	84
3.2.2	Remove and Replace the Existing CPU .....	90
3.2.3	DDR5 SO-DIMM Installation .....	97
3.2.4	mPCIe Module, Mini-SIM (2FF) Card and Antenna Installation .....	99
3.2.5	M.2 2242 (B Key) Module and Micro-SIM (3FF) Card Installation.....	102
3.2.6	M.2 2280 NVMe SSD Installation.....	106
3.2.7	MezIO™ Module Installation .....	108
3.2.8	HDD/ SSD Installation (Nuvo-9100 VTC Series Systems).....	111
3.2.9	HDD/ SSD Installation to Hot-swappable Tray .....	114
3.2.10	Ethernet/ PoE+ Port Panel Screw Fix .....	116
3.2.11	PCIe Card Installation into Cassette Module (Nuvo-9200VTC) .....	117
<b>3.3</b>	<b>Installing the System Enclosure .....</b>	<b>121</b>
<b>3.4</b>	<b>Damping Bracket Installation .....</b>	<b>127</b>
3.4.1	Nuvo-9100VTC Series Damping Bracket Installation.....	127
3.4.2	Nuvo-9200VTC Series Damping Bracket Installation.....	128
<b>3.5</b>	<b>Powering On the System .....</b>	<b>129</b>
3.5.1	Powering On Using the Power Button.....	129
3.5.2	Powering On Using External Non-latched Switch .....	130
3.5.3	Powering On Using Wake-on-LAN.....	131
<b>3.6</b>	<b>Ignition Power Control.....</b>	<b>133</b>
3.6.1	Principles of Ignition Power Control .....	133
3.6.2	Additional Features of Ignition Power Control .....	134
3.6.3	Wiring Ignition Signal .....	135
3.6.4	Configure your Windows system.....	136
3.6.5	Operation Modes of Ignition Power Control .....	137
3.6.6	BIOS Ignition Power Control [Mode 15 (F)].....	140

### 4 System Configuration

<b>4.1</b>	<b>BIOS Settings .....</b>	<b>144</b>
4.1.1	COM Port Configuration.....	145
4.1.2	COM Port High Speed Mode .....	146
4.1.3	Delay for PEG Initialization .....	147
4.1.4	Volume Management Device (VMD).....	148
4.1.5	TPM Availability.....	151
4.1.6	Power over Ethernet (PoE) Power Enable.....	152
4.1.7	Auto Wake on S5 .....	154
4.1.8	Power On After Power Failure Option .....	155
4.1.9	Power & Performance (CPU SKU Power Configuration) .....	156
4.1.10	Active Performance/ Efficient Cores .....	157
4.1.11	Wake on LAN Option .....	159

4.1.12	Boot Menu .....	160
4.1.13	Add Boot Options (Position New Boot Device) .....	162
4.1.14	Watchdog Timer for Booting.....	163
<b>4.2</b>	<b>AMT Configuration .....</b>	<b>164</b>
<b>4.3</b>	<b>RAID Configuration .....</b>	<b>166</b>
4.3.1	Enabling Volume Management Device (VMD) for RAID Volume Setup .....	166
4.3.2	RAID Volume Setup .....	168
4.3.3	Loading RAID Driver for Windows Installation .....	175

## **5 OS Support and Driver Installation**

<b>5.1</b>	<b>Operating System Compatibility .....</b>	<b>178</b>
<b>5.2</b>	<b>System Driver Installation .....</b>	<b>179</b>
<b>5.3</b>	<b>Driver Installation for Watchdog Timer Control .....</b>	<b>179</b>

## **Appendix A Using WDT & DIO**

<b>WDT and DIO Library Installation .....</b>	<b>181</b>
<b>WDT Functions.....</b>	<b>183</b>
InitWDT .....	183
SetWDT .....	183
StartWDT .....	184
ResetWDT .....	184
StopWDT .....	184

## **Appendix B PoE On/ Off Control**

<b>GetStatusPoEPort .....</b>	<b>185</b>
<b>EnablePoEPort .....</b>	<b>187</b>
<b>DisablePoEPort .....</b>	<b>188</b>



# Legal Information

All Neosys Technology Inc. products shall be subject to the latest Standard Warranty Policy

Neosys Technology Inc. may modify, update or upgrade the software, firmware or any accompanying user documentation without any prior notice. Neosys Technology Inc. will provide access to these new software, firmware or documentation releases from download sections of our website or through our service partners.

Before installing any software, applications or components provided by a third party, customer should ensure that they are compatible and interoperable with Neosys Technology Inc. product by checking in advance with Neosys Technology Inc.. Customer is solely responsible for ensuring the compatibility and interoperability of the third party's products. Customer is further solely responsible for ensuring its systems, software, and data are adequately backed up as a precaution against possible failures, alternation, or loss.

For questions in regards to hardware/ software compatibility, customers should contact Neosys Technology Inc. sales representative or technical support.

To the extent permitted by applicable laws, Neosys Technology Inc. shall NOT be responsible for any interoperability or compatibility issues that may arise when (1) products, software, or options not certified and supported; (2) configurations not certified and supported are used; (3) parts intended for one system is installed in another system of different make or model.

# Contact Information

---

**Headquarters**  
**(Taipei, Taiwan)**      **Neosys Technology Inc.**  
15F, No.868-3, Zhongzheng Rd., Zhonghe Dist., New Taipei City, 23586, Taiwan  
Tel: +886-2-2223-6182 Fax: +886-2-2223-6183 [Email](#), [Website](#)

---

**Americas**  
**(Illinois, USA)**      **Neosys Technology America Inc.**  
3384 Commercial Avenue, Northbrook, IL 60062, USA  
Tel: +1-847-656-3298 [Email](#), [Website](#)

---

**China**      **Neosys Technology (China) Ltd.**  
Room 612, Building 32, Guiping Road 680, Shanghai  
Tel: +86-2161155366 [Email](#), [Website](#)

---

# Declaration of Conformity

**FCC**      This equipment has been tested and found to comply with the limits for a Class A digital device, pursuant to part 15 of the FCC Rules. These limits are designed to provide reasonable protection against harmful interference when the equipment is operated in a commercial environment. This equipment generates, uses, and can radiate radio frequency energy and, if not installed and used in accordance with the instruction manual, may cause harmful interference to radio communications. Operation of this equipment in a residential area is likely to cause harmful interference in which case the user will be required to correct the interference at own expense.

---

**CE**      The product(s) described in this manual complies with all applicable European Union (CE) directives if it has a CE marking. For computer systems to remain CE compliant, only CE-compliant parts may be used. Maintaining CE compliance also requires proper cable and cabling techniques.

# Copyright Notice

All rights reserved. This publication may not be reproduced, transmitted, transcribed, stored in a retrieval system, or translated into any language or computer language, in any form or by any means, electronic, mechanical, magnetic, optical, chemical, manual or otherwise, without the prior written consent of Neosys Technology, Inc.

---

**Disclaimer**

This manual is intended to be used as an informative guide only and is subject to change without prior notice. It does not represent commitment from Neosys Technology Inc. Neosys Technology Inc. shall not be liable for any direct, indirect, special, incidental, or consequential damages arising from the use of the product or documentation, nor for any infringement on third party rights.

---

**Patents and Trademarks**

Neosys, the Neosys logo, Expansion Cassette, MezIO™ are registered patents and trademarks of Neosys Technology, Inc.

Windows is a registered trademark of Microsoft Corporation.

Intel®, Core™ are registered trademarks of Intel Corporation

NVIDIA® is a registered trademark of NVIDIA Corporation

All other names, brands, products or services are trademarks or registered trademarks of their respective owners.

# Safety Precautions

- Read these instructions carefully before you install, operate, or transport the system.
- Install the system or DIN rail associated with, at a sturdy location
- Install the power socket outlet near the system where it is easily accessible
- Secure each system module(s) using its retaining screws
- Place power cords and other connection cables away from foot traffic. Do not place items over power cords and make sure they do not rest against data cables
- Shutdown, disconnect all cables from the system and ground yourself before touching internal modules
- Ensure that the correct power range is being used before powering the device
- Should a module fail, arrange for a replacement as soon as possible to minimize down-time
- By means of a power cord connected to a socket-outlet with earthing connection
- This product is intended to be supplied by a Listed Power Adapter or DC power source, rated 24Vdc, 16A, Tma 60 degree C and 5000m altitude during operation. If further assistance is required, please contact Neousys Technology
- If the system is not going to be used for a long time, disconnect it from mains (power socket) to avoid transient over-voltage

## Hot Surface Warning



*HOT SURFACE. DO NOT TOUCH.* "ATTENTION: Surface chaude. Ne pas toucher."

### WARNING!

Components/ parts inside the equipment may be hot to touch!  
Please wait one-half hour after switching off before handling parts.

## Battery Warning

**Caution!**



- Batteries are at risk of exploding if incorrectly installed
- Do not attempt to recharge, force open, or heat the battery
- Replace the battery only with the same or equivalent type recommended by the manufacturer

## Service and Maintenance

- ONLY qualified personnel should service the system
- Shutdown the system, disconnect the power cord and all other connections before servicing the system
- When replacing/ installing additional components (expansion card, memory module, etc.), insert them as gently as possible while assuring proper connector engagement

## ESD Precautions

- Handle add-on module, motherboard by their retention screws or the module's frame/ heat sink. Avoid touching the PCB circuit board or add-on module connector pins
- Use a grounded wrist strap and an anti-static work pad to discharge static electricity when installing or maintaining the system
- Avoid dust, debris, carpets, plastic, vinyl and styrofoam in your work area.
- Do not remove any module or component from its anti-static bag before installation

## Restricted Access Location

The controller is intended for installation only in the certain environment where both these condition apply:

- Access can only be gained by SERVICE PERSONS or by USERS who have been instructed about the reasons for the restrictions applied to the location and about any precautions that shall be taken
- Access is through the use of a TOOL or lock and key, or other means of security, and is controlled by the authority responsible for the location.

# About This Manual

This manual introduces Neosys' in-vehicle Nuvo-9000VTC series featuring Intel® 13<sup>th</sup>/ 12<sup>th</sup> Gen Core™ CPU up to 24 cores/ 32 threads.

The guide also demonstrates the system's disassembly and installation procedures.

## Revision History

Version	Date	Description
1.0	Sep. 2023	Initial release
1.1	Nov. 2023	Updated shock and vibration certifications
1.2	Jun. 2024	Updated SIM card installation orientation underneath the MezIO card

# 1 Introduction

Nuvo-9000VTC series is Neosys' latest rugged in-vehicle controller based on Intel® 13th/ 12th-Gen Core™ processors. Benefiting from cutting-edge Intel 7 photolithography, the latest Core™ desktop processors come with up to 24 cores/ 32 threads, offering an incredible boost of computational performance. Combining DDR5 memory bandwidth throughput and PCIe Gen4 NVMe high-speed disk read/write, users can expect an overall system performance improvement of up to 1.8x when compared to previous 10th or 11th-Gen platforms.



**Nuvo-9100VTC series**



**Nuvo-9200VTC series**

Ideal for advanced in-vehicle applications, Nuvo-9000VTC series offers an assortment of peripherals, connections, and expansion flexibility. It has 2.5Gb and 1Gb Ethernet ports, and four or eight 802.3at PoE+ ports to supply a total of 100W power to connected devices such as IP cameras. Certain models have x-coded M12 connectors and screw-lock mechanisms on I/Os such as Ethernet, USB 3.2 Gen1 and USB 3.2 Gen2 ports to guarantee extreme rugged connectivity in shock/ vibration environments. Internal expansion wise, there are two M.2 and three mini-PCIe sockets to install 5G/ 4G, WiFi, GPS, and CAN module for wireless communication. For Nuvo-9200VTC systems, there is a Cassette module with an additional PCIe slot of an add-on card, and dual hot-swappable SATA HDD trays, making it that much more flexible for in-vehicle applications

On top of all that, the system also features isolated CAN bus for in-vehicle communication, isolated DIO for sensor/ actuator control, 8V to 48V wide-range DC input with ignition power control.

## 1.1 Nuvo-9100VTC Series Specifications

### 1.1.1 Nuvo-9100VTC Specifications

<b>System Core</b>	
Processor	<p>Supports Intel® 13th-Gen Core™ CPU (LGA1700 socket, 65W/ 35W TDP)</p> <ul style="list-style-type: none"> <li>- Intel® Core™ i9-13900E/ i9-13900TE</li> <li>- Intel® Core™ i7-13700E/ i7-13700TE</li> <li>- Intel® Core™ i5-13500E/ i5-13400E/ i5-13500TE</li> <li>- Intel® Core™ i3-13100E/ i3-13100TE</li> </ul> <p>Supports Intel® 12th-Gen Core™ CPU (LGA1700 socket, 65W/ 35W TDP)</p> <ul style="list-style-type: none"> <li>- Intel® Core™ i9-12900E/ i9-12900TE</li> <li>- Intel® Core™ i7-12700E/ i7-12700TE</li> <li>- Intel® Core™ i5-12500E/ i5-12500TE</li> <li>- Intel® Core™ i3-12100E/ i3-12100TE</li> <li>- Intel® Pentium® G7400E/ G7400TE</li> <li>- Intel® Celeron® G6900E/ G6900TE</li> </ul>
Chipset	Intel® Q670E Platform Controller Hub
Graphics	Integrated Intel® UHD Graphics 770 (32EU)
Memory	Up to 64GB DDR5 4800 (two SODIMM slots)
AMT	Supports Intel vPro/ AMT 16.0
TPM	Supports dTPM 2.0
<b>I/O Interface</b>	
Ethernet port	1x 2.5Gb Ethernet 1x Gb Ethernet
PoE+	4x 2.5GbE with PoE+ ports via M12 X-coded connectors (100W total power budget)
USB	1x USB 3.2 Gen2x2 (20 Gbps) port in type-C connector with screw-lock 4x USB 3.2 Gen2x1 (10 Gbps) ports in type-A connectors 2x USB 3.2 Gen1x1 (5 Gbps) ports in type-A connectors 2x USB 2.0 ports
CAN bus	1x isolated CAN 2.0 port
Video Port	1x VGA connector, supporting 1920 x 1200 resolution 1x DVI-D connector, supporting 1920 x 1200 resolution 1x DisplayPort connector, supporting 4096 x 2304 resolution



Serial Port	2x software-programmable RS-232/ 422/ 485 ports (COM1/ COM2) 2x RS-232 ports (COM3/ COM4)	
Audio	1x 3.5 mm jack for mic-in and speaker-out	
Isolated DIO	4-CH isolated DI and 4-CH isolated DO	
<b>Storage Interface</b>		
SATA HDD	1x hot-swappable 2.5" HDD tray (7mm HDD/ SSD) and 1x internal 2.5" SATA ports	
M.2 NVMe	1x M.2 2280 M key NVMe socket (PCIe Gen4 x4) for NVMe SSD	
<b>Internal Expansion Bus</b>		
Mini PCI-E	1x full-size mini-PCIe socket 2x full-size mini-PCIe sockets (USB signal only) with internal SIM sockets	
M.2	1x M.2 2242/3052 B key socket with SIM slot for M.2 5G/ 4G module 1x M.2 2242/3052 B key socket with SIM slot for M.2 4G module	
<b>Power Supply</b>		
DC Input	1x 3-pin pluggable terminal block for 8~48VDC DC input	
Remote Ctrl. & LED Output	1x 3-pin pluggable terminal block for remote control and PWR LED output	
Maximum Power Consumption (reference only, may differ depending on configuration)	With i7-12700 (65W mode): 141.4W (Max.) @ 24V With i7-12700 (65W mode): 146.4W (Max.) @ 48V With i7-12700TE (35W mode): 106.6W (Max.) @ 24V With i7-12700TE (35W mode): 111.8W (Max.) @ 48V With i5-12400 (35W mode): 105.1W (Max.) @ 24V With i5-12400 (35W mode): 110.9W (Max.) @ 48V With i5-12400 (65W mode): 120.5W (Max.) @ 24V With i5-12400 (65W mode): 126.2W (Max.) @ 48V	
<b>Mechanical</b>		
Dimension	240 mm (W) x 225 mm (D) x 84 mm (H)	
Weight	3.7Kg (approx.)	
Mounting	Wall-mount with damping bracket (standard)	
<b>Environmental</b>		
Operating Temperature	<b>With 35W CPU</b> -40°C ~ 70°C <sup>[1]/ [2]/ [3]</sup> -40°C ~ 60°C <sup>[2]/ [4]</sup>	<b>With 65W CPU</b> -40°C ~ 50°C <sup>[2]/ [4]/ [5]</sup>
Storage Temperature	-40°C to 85°C	
Humidity	10%~90% , non-condensing	
Vibration	EN 50155:2017/ IEC 61373, Category I, Class B - Body mounted	

Shock	EN 50155:2017/ IEC 61373, Category I, Class B - Body mounted
EMC	CE/ FCC Class A, according to EN 55032 & EN 55035 E-Mark, EN 50121 (EN 50155 EMC)

*[1] Due to DDR5 memory's heat generation, please configure the CPU to 35W mode and install only one memory slot.*

*[2] For sub-zero operating temperature, a wide temperature HDD or Solid State Disk (SSD) is required.*

*[3] With one memory module installed*

*[4] With two memory modules installed*

*[5] When CPU is operating under 65W mode, the highest operating temperature shall be limited to 50°C. Thermal throttling may occur when sustained full-load is applied. To achieve higher operating temperatures, users can configure the CPU TDP setting in the BIOS.*

## 1.1.2 Nuvo-9104VTC Specifications

<b>System Core</b>	
Processor	Supports Intel® 13th-Gen Core™ CPU (LGA1700 socket, 65W/ 35W TDP) <ul style="list-style-type: none"> <li>- Intel® Core™ i9-13900E/ i9-13900TE</li> <li>- Intel® Core™ i7-13700E/ i7-13700TE</li> <li>- Intel® Core™ i5-13500E/ i5-13400E/ i5-13500TE</li> <li>- Intel® Core™ i3-13100E/ i3-13100TE</li> </ul> Supports Intel® 12th-Gen Core™ CPU (LGA1700 socket, 65W/ 35W TDP) <ul style="list-style-type: none"> <li>- Intel® Core™ i9-12900E/ i9-12900TE</li> <li>- Intel® Core™ i7-12700E/ i7-12700TE</li> <li>- Intel® Core™ i5-12500E/ i5-12500TE</li> <li>- Intel® Core™ i3-12100E/ i3-12100TE</li> <li>- Intel® Pentium® G7400E/ G7400TE</li> <li>- Intel® Celeron® G6900E/ G6900TE</li> </ul>
Chipset	Intel® Q670E Platform Controller Hub
Graphics	Integrated Intel® UHD Graphics 770 (32EU)
Memory	Up to 64GB DDR5 4800 (two SODIMM slots)
AMT	Supports Intel vPro/ AMT 16.0
TPM	Supports dTPM 2.0
<b>I/O Interface</b>	
Ethernet port	1x 2.5GbE 1x GbE
PoE+	4x 2.5GbE with PoE+ ports via RJ45 connectors (100W total power budget)
USB	1x USB 3.2 Gen2x2 (20 Gbps) port in type-C connector with screw-lock 4x USB 3.2 Gen2x1 (10 Gbps) ports in type-A connectors 2x USB 3.2 Gen1x1 (5 Gbps) ports in type-A connectors 2x USB 2.0 ports
CAN bus	1x isolated CAN 2.0 port
Video Port	1x VGA connector, supporting 1920 x 1200 resolution 1x DVI-D connector, supporting 1920 x 1200 resolution 1x DisplayPort connector, supporting 4096 x 2304 resolution
Serial Port	2x software-programmable RS-232/ 422/ 485 ports (COM1/ COM2) 2x RS-232 ports (COM3/ COM4)
Audio	1x 3.5 mm jack for mic-in and speaker-out

Isolated DIO	4-CH isolated DI and 4-CH isolated DO	
<b>Storage Interface</b>		
SATA HDD	1x hot-swappable 2.5" HDD tray (7mm HDD/ SSD) and 1x internal 2.5" SATA ports	
M.2 NVMe	1x M.2 2280 M key NVMe socket (PCIe Gen4 x4) for NVMe SSD	
<b>Internal Expansion Bus</b>		
Mini PCI-E	1x full-size mini-PCIe socket 2x full-size mini-PCIe sockets (USB signal only) with internal SIM sockets	
M.2	1x M.2 2242/3052 B key socket with SIM slot for M.2 5G/ 4G module 1x M.2 2242/3052 B key socket with SIM slot for M.2 4G module	
<b>Power Supply</b>		
DC Input	1x 3-pin pluggable terminal block for 8~48VDC DC input	
Remote Ctrl. & LED Output	1x 3-pin pluggable terminal block for remote control and PWR LED output	
Maximum Power Consumption (reference only, may differ depending on configuration)	With i7-12700 (65W mode): 141.4W (Max.) @ 24V With i7-12700 (65W mode): 146.4W (Max.) @ 48V With i7-12700TE (35W mode): 106.6W (Max.) @ 24V With i7-12700TE (35W mode): 111.8W (Max.) @ 48V With i5-12400 (35W mode): 105.1W (Max.) @ 24V With i5-12400 (35W mode): 110.9W (Max.) @ 48V With i5-12400 (65W mode): 120.5W (Max.) @ 24V With i5-12400 (65W mode): 126.2W (Max.) @ 48V	
<b>Mechanical</b>		
Dimension	240 mm (W) x 225 mm (D) x 84 mm (H)	
Weight	3.7Kg (approx.)	
Mounting	Wall-mount with damping bracket (standard)	
<b>Environmental</b>		
Operating Temperature	<b>With 35W CPU</b> -40°C ~ 70°C [1]/ [2]/ [3] -40°C ~ 60°C [2]/ [4]	<b>With 65W CPU</b> -40°C ~ 50°C [2]/ [4]/ [5]
Storage Temperature	-40°C to 85°C	
Humidity	10%~90% , non-condensing	
Vibration	EN 50155:2017/ IEC 61373, Category I, Class B - Body mounted	
Shock	EN 50155:2017/ IEC 61373, Category I, Class B - Body mounted	
EMC	CE/ FCC Class A, according to EN 55032 & EN 55035 E-Mark, EN 50121 (EN 50155 EMC)	

*[1] Due to DDR5 memory's heat generation, please configure the CPU to 35W mode and install only one memory slot.*

*[2] For sub-zero operating temperature, a wide temperature HDD or Solid State Disk (SSD) is required.*

*[3] With one memory module installed*

*[4] With two memory modules installed*

*[5] When CPU is operating under 65W mode, the highest operating temperature shall be limited to 50°C. Thermal throttling may occur when sustained full-load is applied. To achieve higher operating temperatures, users can configure the CPU TDP setting in the BIOS.*

### 1.1.3 Nuvo-9108VTC Specifications

<b>System Core</b>	
Processor	<p>Supports Intel® 13th-Gen Core™ CPU (LGA1700 socket, 65W/ 35W TDP)</p> <ul style="list-style-type: none"> <li>- Intel® Core™ i9-13900E/ i9-13900TE</li> <li>- Intel® Core™ i7-13700E/ i7-13700TE</li> <li>- Intel® Core™ i5-13500E/ i5-13400E/ i5-13500TE</li> <li>- Intel® Core™ i3-13100E/ i3-13100TE</li> </ul> <p>Supports Intel® 12th-Gen Core™ CPU (LGA1700 socket, 65W/ 35W TDP)</p> <ul style="list-style-type: none"> <li>- Intel® Core™ i9-12900E/ i9-12900TE</li> <li>- Intel® Core™ i7-12700E/ i7-12700TE</li> <li>- Intel® Core™ i5-12500E/ i5-12500TE</li> <li>- Intel® Core™ i3-12100E/ i3-12100TE</li> <li>- Intel® Pentium® G7400E/ G7400TE</li> <li>- Intel® Celeron® G6900E/ G6900TE</li> </ul>
Chipset	Intel® Q670E Platform Controller Hub
Graphics	Integrated Intel® UHD Graphics 770 (32EU)
Memory	Up to 64GB DDR5 4800 (two SODIMM slots)
AMT	Supports Intel vPro/ AMT 16.0
TPM	Supports dTPM 2.0
<b>I/O Interface</b>	
Ethernet port	1x 2.5GbE 1x GbE
PoE+	4x Gigabit PoE+ via RJ45 connectors and 4x 2.5GbE with PoE+ ports via RJ45 connectors (100W total power budget)
USB	1x USB 3.2 Gen2x2 (20 Gbps) port in type-C connector with screw-lock 4x USB 3.2 Gen2x1 (10 Gbps) ports in type-A connectors 2x USB 3.2 Gen1x1 (5 Gbps) ports in type-A connectors 2x USB 2.0 ports
CAN bus	1x isolated CAN 2.0 port
Video Port	1x VGA connector, supporting 1920 x 1200 resolution 1x DVI-D connector, supporting 1920 x 1200 resolution 1x DisplayPort connector, supporting 4096 x 2304 resolution
Serial Port	2x software-programmable RS-232/ 422/ 485 ports (COM1/ COM2) 2x RS-232 ports (COM3/ COM4)
Audio	1x 3.5 mm jack for mic-in and speaker-out

Isolated DIO	4-CH isolated DI and 4-CH isolated DO	
<b>Storage Interface</b>		
SATA HDD	1x hot-swappable 2.5" HDD tray (7mm HDD/ SSD) and 1x internal 2.5" SATA ports	
M.2 NVMe	1x M.2 2280 M key NVMe socket (PCIe Gen4 x4) for NVMe SSD	
<b>Internal Expansion Bus</b>		
Mini PCI-E	1x full-size mini-PCIe socket 2x full-size mini-PCIe sockets (USB signal only) with internal SIM sockets	
M.2	1x M.2 2242/3052 B key socket with SIM slot for M.2 5G/ 4G module 1x M.2 2242/3052 B key socket with SIM slot for M.2 4G module	
<b>Power Supply</b>		
DC Input	1x 3-pin pluggable terminal block for 8~48VDC DC input	
Remote Ctrl. & LED Output	1x 3-pin pluggable terminal block for remote control and PWR LED output	
Maximum Power Consumption (reference only, may differ depending on configuration)	With i7-12700 (65W mode): 141.4W (Max.) @ 24V With i7-12700 (65W mode): 146.4W (Max.) @ 48V With i7-12700TE (35W mode): 106.6W (Max.) @ 24V With i7-12700TE (35W mode): 111.8W (Max.) @ 48V With i5-12400 (35W mode): 105.1W (Max.) @ 24V With i5-12400 (35W mode): 110.9W (Max.) @ 48V With i5-12400 (65W mode): 120.5W (Max.) @ 24V With i5-12400 (65W mode): 126.2W (Max.) @ 48V	
<b>Mechanical</b>		
Dimension	240 mm (W) x 225 mm (D) x 84 mm (H)	
Weight	3.7Kg (approx.)	
Mounting	Wall-mount with damping bracket (standard)	
<b>Environmental</b>		
Operating Temperature	<b>With 35W CPU</b> -40°C ~ 70°C [1]/ [2]/ [3] -40°C ~ 60°C [2]/ [4]	<b>With 65W CPU</b> -40°C ~ 50°C [2]/ [4]/ [5]
Storage Temperature	-40°C to 85°C	
Humidity	10%~90% , non-condensing	
Vibration	EN 50155:2017/ IEC 61373, Category I, Class B - Body mounted	
Shock	EN 50155:2017/ IEC 61373, Category I, Class B - Body mounted	
EMC	CE/ FCC Class A, according to EN 55032 & EN 55035 E-Mark, EN 50121 (EN 50155 EMC)	

*[1] Due to DDR5 memory's heat generation, please configure the CPU to 35W mode and install only one memory slot.*

*[2] For sub-zero operating temperature, a wide temperature HDD or Solid State Disk (SSD) is required.*

*[3] With one memory module installed*

*[4] With two memory modules installed*

*[5] When CPU is operating under 65W mode, the highest operating temperature shall be limited to 50°C. Thermal throttling may occur when sustained full-load is applied. To achieve higher operating temperatures, users can configure the CPU TDP setting in the BIOS.*



## 1.2 Nuvo-9200VTC Series Specifications

### 1.2.1 Nuvo-9200VTC Specifications

System Core	
Processor	Supports Intel® 13th-Gen Core™ CPU (LGA1700 socket, 65W/ 35W TDP) - Intel® Core™ i9-13900E/ i9-13900TE - Intel® Core™ i7-13700E/ i7-13700TE - Intel® Core™ i5-13500E/ i5-13400E/ i5-13500TE - Intel® Core™ i3-13100E/ i3-13100TE
	Supports Intel® 12th-Gen Core™ CPU (LGA1700 socket, 65W/ 35W TDP) - Intel® Core™ i9-12900E/ i9-12900TE - Intel® Core™ i7-12700E/ i7-12700TE - Intel® Core™ i5-12500E/ i5-12500TE - Intel® Core™ i3-12100E/ i3-12100TE - Intel® Pentium® G7400E/ G7400TE - Intel® Celeron® G6900E/ G6900TE
Chipset	Intel® Q670E Platform Controller Hub
Graphics	Integrated Intel® UHD Graphics 770 (32EU)
Memory	Up to 64GB DDR5 4800 (two SODIMM slots)
AMT	Supports Intel vPro/ AMT 16.0
TPM	Supports dTPM 2.0
I/O Interface	
Ethernet port	1x 2.5GbE 1x GbE
PoE+	4x 2.5GbE with PoE+ ports via M12 X-coded connectors (100W total power budget)
USB	1x USB 3.2 Gen2x2 (20 Gbps) port in type-C connector with screw-lock 4x USB 3.2 Gen2x1 (10 Gbps) ports in type-A connectors 2x USB 3.2 Gen1x1 (5 Gbps) ports in type-A connectors 2x USB 2.0 ports
CAN bus	1x isolated CAN 2.0 port
Video Port	1x VGA connector, supporting 1920 x 1200 resolution 1x DVI-D connector, supporting 1920 x 1200 resolution 1x DisplayPort connector, supporting 4096 x 2304 resolution
Serial Port	2x software-programmable RS-232/ 422/ 485 ports (COM1/ COM2)

	2x RS-232 ports (COM3/ COM4)	
Audio	1x 3.5 mm jack for mic-in and speaker-out	
Isolated DIO	4-CH isolated DI and 4-CH isolated DO	
<b>Storage Interface</b>		
SATA HDD	2x hot-swappable HDD trays for 2.5" HDD/ SSD installation, supporting RAID 0/ 1	
M.2 NVMe	1x M.2 2280 M key NVMe socket (PCIe Gen4 x4) for NVMe SSD	
<b>Internal Expansion Bus</b>		
PCIe Slot	1x PCIe x16 slots@Gen3, 16-lanes PCIe signal in Cassette module	
Mini PCI-E	1x full-size mini-PCIe socket 2x full-size mini-PCIe sockets (USB signal only) with internal SIM sockets	
M.2	1x M.2 2242/3052 B key socket with SIM slot for M.2 5G/ 4G module 1x M.2 2242/3052 B key socket with SIM slot for M.2 4G module	
<b>Power Supply</b>		
DC Input	1x 3-pin pluggable terminal block for 8~48VDC DC input	
Remote Ctrl. & LED Output	1x 3-pin pluggable terminal block for remote control and PWR LED output	
Maximum Power Consumption (reference only, may differ depending on configuration)	With i7-12700 (65W mode): 141.4W (Max.) @ 24V With i7-12700 (65W mode): 146.4W (Max.) @ 48V With i7-12700TE (35W mode): 106.6W (Max.) @ 24V With i7-12700TE (35W mode): 111.8W (Max.) @ 48V With i5-12400 (35W mode): 105.1W (Max.) @ 24V With i5-12400 (35W mode): 110.9W (Max.) @ 48V With i5-12400 (65W mode): 120.5W (Max.) @ 24V With i5-12400 (65W mode): 126.2W (Max.) @ 48V	
<b>Mechanical</b>		
Dimension	240 mm (W) x 225 mm (D) x 103 mm (H)	
Weight	3.9Kg (approx.)	
Mounting	Wall-mount with damping bracket (standard)	
<b>Environmental</b>		
Operating Temperature	<b>With 35W CPU</b> -40°C ~ 70°C <sup>[1]/ [2]/ [3]</sup> -40°C ~ 60°C <sup>[2]/ [4]</sup>	<b>With 65W CPU</b> -40°C ~ 50°C <sup>[2]/ [4]/ [5]</sup>
Storage Temperature	-40°C to 85°C	
Humidity	10%~90% , non-condensing	

Vibration	EN 50155:2017/ IEC 61373, Category I, Class B - Body mounted
Shock	EN 50155:2017/ IEC 61373, Category I, Class B - Body mounted
EMC	CE/ FCC Class A, according to EN 55032 & EN 55035 E-Mark, EN 50121 (EN 50155 EMC)

*[1] Due to DDR5 memory's heat generation, please configure the CPU to 35W mode and install only one memory slot.*

*[2] For sub-zero operating temperature, a wide temperature HDD or Solid State Disk (SSD) is required.*

*[3] With one memory module installed*

*[4] With two memory modules installed*

*[5] When CPU is operating under 65W mode, the highest operating temperature shall be limited to 50°C. Thermal throttling may occur when sustained full-load is applied. To achieve higher operating temperatures, users can configure the CPU TDP setting in the BIOS.*

### 1.2.2 Nuvo-9204VTC Specifications

<b>System Core</b>	
Processor	<p>Supports Intel® 13th-Gen Core™ CPU (LGA1700 socket, 65W/ 35W TDP)</p> <ul style="list-style-type: none"> <li>- Intel® Core™ i9-13900E/ i9-13900TE</li> <li>- Intel® Core™ i7-13700E/ i7-13700TE</li> <li>- Intel® Core™ i5-13500E/ i5-13400E/ i5-13500TE</li> <li>- Intel® Core™ i3-13100E/ i3-13100TE</li> </ul> <p>Supports Intel® 12th-Gen Core™ CPU (LGA1700 socket, 65W/ 35W TDP)</p> <ul style="list-style-type: none"> <li>- Intel® Core™ i9-12900E/ i9-12900TE</li> <li>- Intel® Core™ i7-12700E/ i7-12700TE</li> <li>- Intel® Core™ i5-12500E/ i5-12500TE</li> <li>- Intel® Core™ i3-12100E/ i3-12100TE</li> <li>- Intel® Pentium® G7400E/ G7400TE</li> <li>- Intel® Celeron® G6900E/ G6900TE</li> </ul>
Chipset	Intel® Q670E Platform Controller Hub
Graphics	Integrated Intel® UHD Graphics 770 (32EU)
Memory	Up to 64GB DDR5 4800 (two SODIMM slots)
AMT	Supports Intel vPro/ AMT 16.0
TPM	Supports dTPM 2.0
<b>I/O Interface</b>	
Ethernet port	1x 2.5GbE 1x GbE
PoE+	4x 2.5GbE with PoE+ ports via RJ45 connectors (100W total power budget)
USB	1x USB 3.2 Gen2x2 (20 Gbps) port in type-C connector with screw-lock 4x USB 3.2 Gen2x1 (10 Gbps) ports in type-A connectors 2x USB 3.2 Gen1x1 (5 Gbps) ports in type-A connectors 2x USB 2.0 ports
CAN bus	1x isolated CAN 2.0 port
Video Port	1x VGA connector, supporting 1920 x 1200 resolution 1x DVI-D connector, supporting 1920 x 1200 resolution 1x DisplayPort connector, supporting 4096 x 2304 resolution
Serial Port	2x software-programmable RS-232/ 422/ 485 ports (COM1/ COM2) 2x RS-232 ports (COM3/ COM4)

Audio	1x 3.5 mm jack for mic-in and speaker-out	
Isolated DIO	4-CH isolated DI and 4-CH isolated DO	
<b>Storage Interface</b>		
SATA HDD	2x hot-swappable HDD trays for 2.5" HDD/ SSD installation, supporting RAID 0/ 1	
M.2 NVMe	1x M.2 2280 M key NVMe socket (PCIe Gen4 x4) for NVMe SSD	
<b>Internal Expansion Bus</b>		
PCI Slot	1x PCIe x16 slots@Gen3, 16-lanes PCIe signal in Cassette module	
Mini PCI-E	1x full-size mini-PCIe socket 2x full-size mini-PCIe sockets (USB signal only) with internal SIM sockets	
M.2	1x M.2 2242/3052 B key socket with SIM slot for M.2 5G/ 4G module 1x M.2 2242/3052 B key socket with SIM slot for M.2 4G module	
<b>Power Supply</b>		
DC Input	1x 3-pin pluggable terminal block for 8~48VDC DC input	
Remote Ctrl. & LED Output	1x 3-pin pluggable terminal block for remote control and PWR LED output	
Maximum Power Consumption (reference only, may differ depending on configuration)	With i7-12700 (65W mode): 141.4W (Max.) @ 24V With i7-12700 (65W mode): 146.4W (Max.) @ 48V With i7-12700TE (35W mode): 106.6W (Max.) @ 24V With i7-12700TE (35W mode): 111.8W (Max.) @ 48V With i5-12400 (35W mode): 105.1W (Max.) @ 24V With i5-12400 (35W mode): 110.9W (Max.) @ 48V With i5-12400 (65W mode): 120.5W (Max.) @ 24V With i5-12400 (65W mode): 126.2W (Max.) @ 48V	
<b>Mechanical</b>		
Dimension	240 mm (W) x 225 mm (D) x 103 mm (H)	
Weight	3.9Kg (approx.)	
Mounting	Wall-mount with damping bracket (standard)	
<b>Environmental</b>		
Operating Temperature	<b>With 35W CPU</b> -40°C ~ 70°C [1]/ [2]/ [3] -40°C ~ 60°C [2]/ [4]	<b>With 65W CPU</b> -40°C ~ 50°C [2]/ [4]/ [5]
Storage Temperature	-40°C to 85°C	
Humidity	10%~90% , non-condensing	
Vibration	EN 50155:2017/ IEC 61373, Category I, Class B - Body mounted	
Shock	EN 50155:2017/ IEC 61373, Category I, Class B - Body mounted	

EMC	CE/ FCC Class A, according to EN 55032 & EN 55035 E-Mark, EN 50121 (EN 50155 EMC)
-----	--

*[1] Due to DDR5 memory's heat generation, please configure the CPU to 35W mode and install only one memory slot.*

*[2] For sub-zero operating temperature, a wide temperature HDD or Solid State Disk (SSD) is required.*

*[3] With one memory module installed*

*[4] With two memory modules installed*

*[5] When CPU is operating under 65W mode, the highest operating temperature shall be limited to 50°C. Thermal throttling may occur when sustained full-load is applied. To achieve higher operating temperatures, users can configure the CPU TDP setting in the BIOS.*

### 1.2.3 Nuvo-9208VTC Specifications

<b>System Core</b>	
Processor	Supports Intel® 13th-Gen Core™ CPU (LGA1700 socket, 65W/ 35W TDP) <ul style="list-style-type: none"> <li>- Intel® Core™ i9-13900E/ i9-13900TE</li> <li>- Intel® Core™ i7-13700E/ i7-13700TE</li> <li>- Intel® Core™ i5-13500E/ i5-13400E/ i5-13500TE</li> <li>- Intel® Core™ i3-13100E/ i3-13100TE</li> </ul> Supports Intel® 12th-Gen Core™ CPU (LGA1700 socket, 65W/ 35W TDP) <ul style="list-style-type: none"> <li>- Intel® Core™ i9-12900E/ i9-12900TE</li> <li>- Intel® Core™ i7-12700E/ i7-12700TE</li> <li>- Intel® Core™ i5-12500E/ i5-12500TE</li> <li>- Intel® Core™ i3-12100E/ i3-12100TE</li> <li>- Intel® Pentium® G7400E/ G7400TE</li> <li>- Intel® Celeron® G6900E/ G6900TE</li> </ul>
Chipset	Intel® Q670E Platform Controller Hub
Graphics	Integrated Intel® UHD Graphics 770 (32EU)
Memory	Up to 64GB DDR5 4800 (two SODIMM slots)
AMT	Supports Intel vPro/ AMT 16.0
TPM	Supports dTPM 2.0
<b>I/O Interface</b>	
Ethernet port	1x 2.5GbE 1x GbE
PoE+	4x Gigabit PoE+ and 4x 2.5GbE with PoE+ ports via RJ45 connectors (100W total power budget)
USB	1x USB 3.2 Gen2x2 (20 Gbps) port in type-C connector with screw-lock 4x USB 3.2 Gen2x1 (10 Gbps) ports in type-A connectors 2x USB 3.2 Gen1x1 (5 Gbps) ports in type-A connectors 2x USB 2.0 ports
CAN bus	1x isolated CAN 2.0 port
Video Port	1x VGA connector, supporting 1920 x 1200 resolution 1x DVI-D connector, supporting 1920 x 1200 resolution 1x DisplayPort connector, supporting 4096 x 2304 resolution
Serial Port	2x software-programmable RS-232/ 422/ 485 ports (COM1/ COM2) 2x RS-232 ports (COM3/ COM4)

Audio	1x 3.5 mm jack for mic-in and speaker-out	
Isolated DIO	4-CH isolated DI and 4-CH isolated DO	
<b>Storage Interface</b>		
SATA HDD	2x hot-swappable HDD trays for 2.5" HDD/ SSD installation, supporting RAID 0/ 1	
M.2 NVMe	1x M.2 2280 M key NVMe socket (PCIe Gen4 x4) for NVMe SSD	
<b>Internal Expansion Bus</b>		
PCI Slot	1x PCIe x16 slots@Gen3, 16-lanes PCIe signal in Cassette module	
Mini PCI-E	1x full-size mini-PCIe socket 2x full-size mini-PCIe sockets (USB signal only) with internal SIM sockets	
M.2	1x M.2 2242/3052 B key socket with SIM slot for M.2 5G/ 4G module 1x M.2 2242/3052 B key socket with SIM slot for M.2 4G module	
<b>Power Supply</b>		
DC Input	1x 3-pin pluggable terminal block for 8~48VDC DC input	
Remote Ctrl. & LED Output	1x 3-pin pluggable terminal block for remote control and PWR LED output	
Maximum Power Consumption (reference only, may differ depending on configuration)	With i7-12700 (65W mode): 141.4W (Max.) @ 24V With i7-12700 (65W mode): 146.4W (Max.) @ 48V With i7-12700TE (35W mode): 106.6W (Max.) @ 24V With i7-12700TE (35W mode): 111.8W (Max.) @ 48V With i5-12400 (35W mode): 105.1W (Max.) @ 24V With i5-12400 (35W mode): 110.9W (Max.) @ 48V With i5-12400 (65W mode): 120.5W (Max.) @ 24V With i5-12400 (65W mode): 126.2W (Max.) @ 48V	
<b>Mechanical</b>		
Dimension	240 mm (W) x 225 mm (D) x 103 mm (H)	
Weight	3.9Kg (approx.)	
Mounting	Wall-mount with damping bracket (standard)	
<b>Environmental</b>		
Operating Temperature	<b>With 35W CPU</b> -40°C ~ 70°C [1]/ [2]/ [3] -40°C ~ 60°C [2]/ [4]	<b>With 65W CPU</b> -40°C ~ 50°C [2]/ [4]/ [5]
Storage Temperature	-40°C to 85°C	
Humidity	10%~90% , non-condensing	
Vibration	EN 50155:2017/ IEC 61373, Category I, Class B - Body mounted	
Shock	EN 50155:2017/ IEC 61373, Category I, Class B - Body mounted	



EMC	CE/ FCC Class A, according to EN 55032 & EN 55035 E-Mark, EN 50121 (EN 50155 EMC)
-----	--

*[1] Due to DDR5 memory's heat generation, please configure the CPU to 35W mode and install only one memory slot.*

*[2] For sub-zero operating temperature, a wide temperature HDD or Solid State Disk (SSD) is required.*

*[3] With one memory module installed*

*[4] With two memory modules installed*

*[5] When CPU is operating under 65W mode, the highest operating temperature shall be limited to 50°C. Thermal throttling may occur when sustained full-load is applied. To achieve higher operating temperatures, users can configure the CPU TDP setting in the BIOS.*

### 1.3 Isolated DIO Specifications

<b>Isolated Digital Input</b>	
No. of Channel	4-CH Isolated Digital Input Channels
Logic Level	Logic High: 5 to 24V Logic Low: 0 to 1.5V
Isolated Voltage	2500 Vrms
Input Resistance	1k $\Omega$
Operation Mode	Polling I/O, Change-of-State Interrupt
<b>Isolated Digital Output</b>	
No. of Channel	4-CH Isolated Digital Output Channels
Sink Current (per channel)	100 mA (sustained loading) 250 mA (peak loading)
Isolated Voltage	2500 Vrms
Operation Mode	Polling, Change-of-State Interrupt
Output Type	Power MOSFET + Analog Device iCoupler®
Operation Mode	Polling I/O and Change-of-State interrupt for DI

## 1.4 Nuvo-9100VTC Series Dimension

 **NOTE**

*All measurements are in millimeters (mm).*

### 1.4.1 Nuvo-9100VTC Series Front Panel View

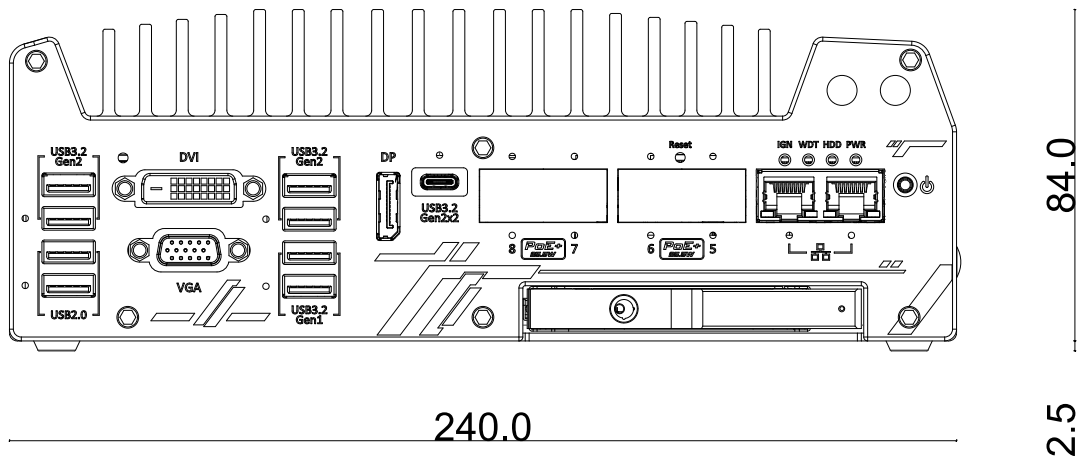

### 1.4.2 Nuvo-9100VTC Series Rear Panel View

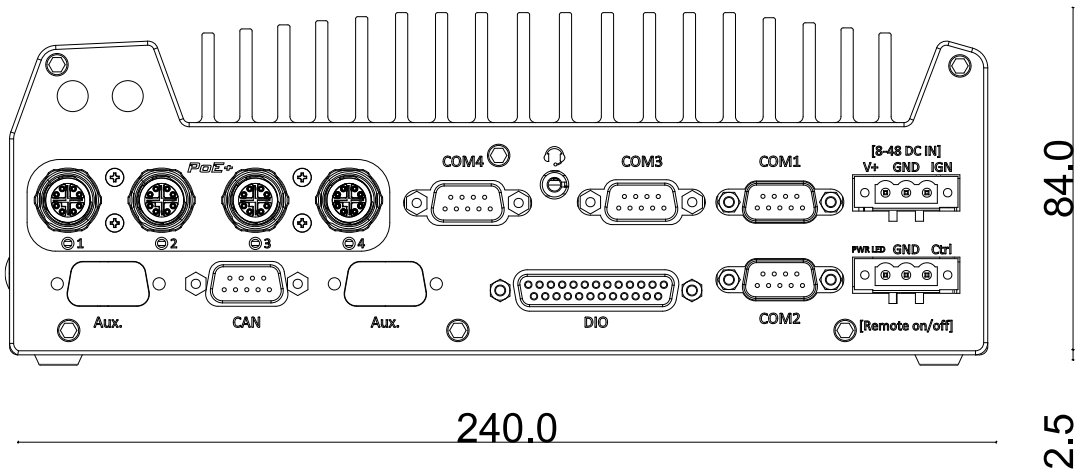

### 1.4.3 Nuvo-9100VTC Series Top View

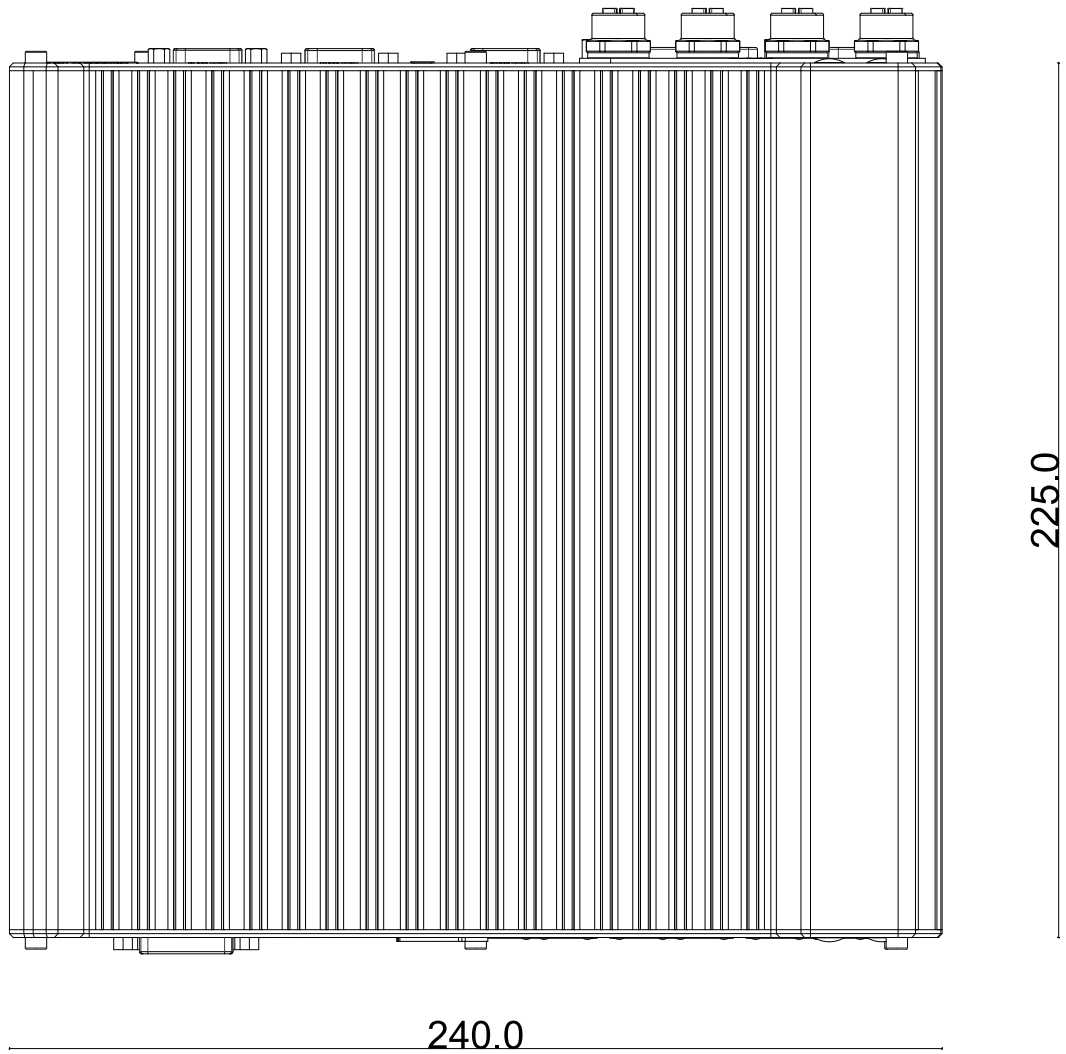

### 1.4.4 Nuvo-9100VTC Series Bottom View

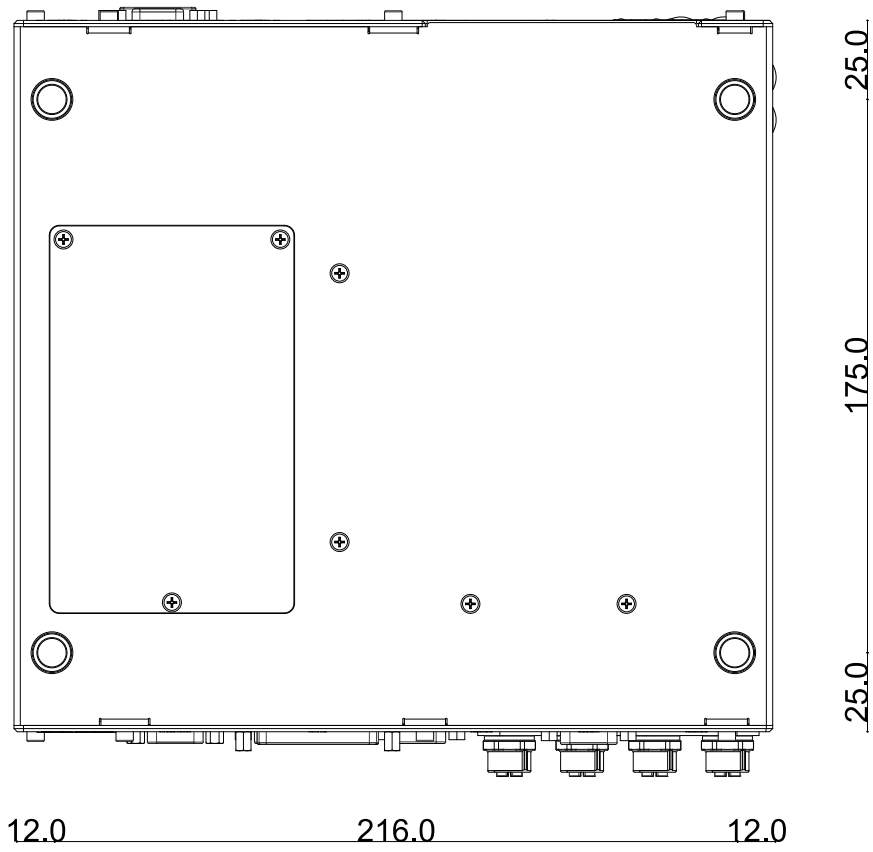

### 1.4.5 Nuvo-9100VTC Series with Damping Bracket

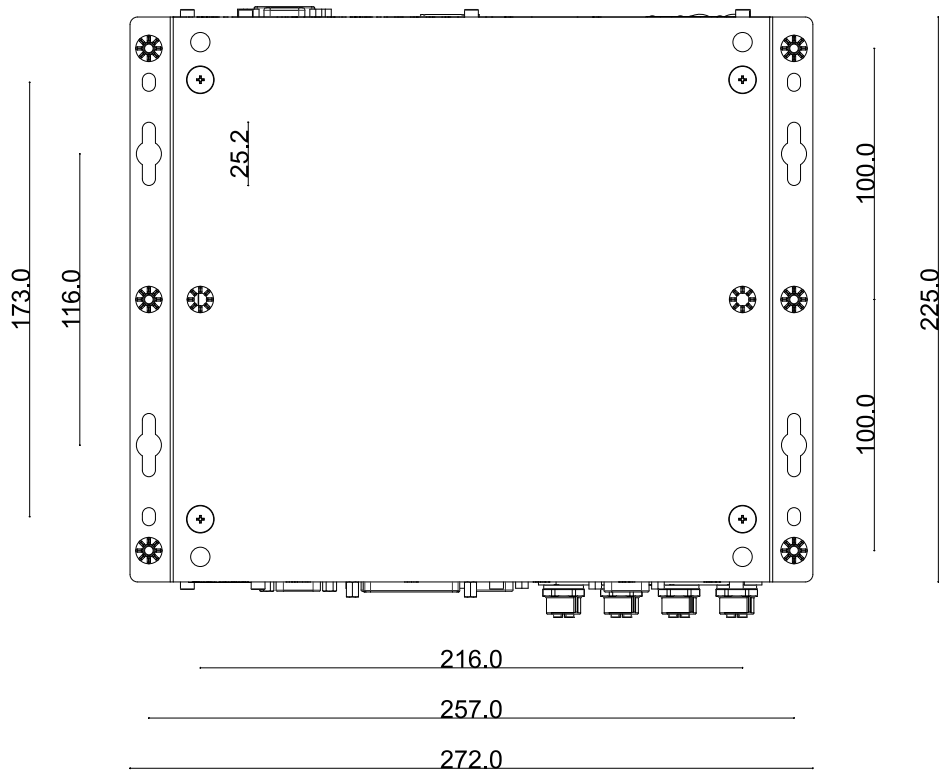

## 1.5 Nuvo-9200VTC Series Dimension

 **NOTE**  
*All measurements are in millimeters (mm).*

### 1.5.1 Nuvo-9200VTC Series Front Panel View

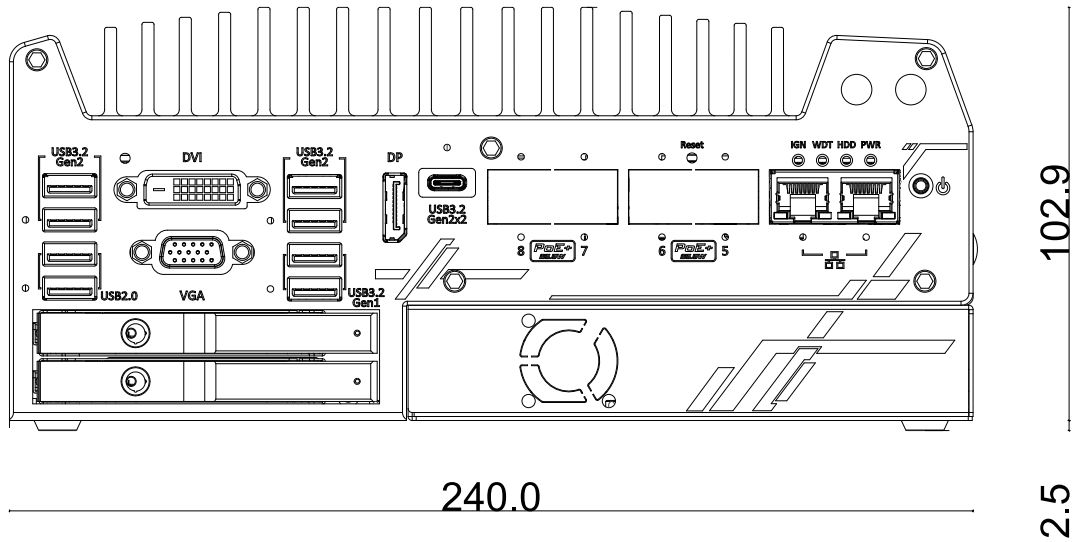

### 1.5.2 Nuvo-9200VTC Series Rear Panel View

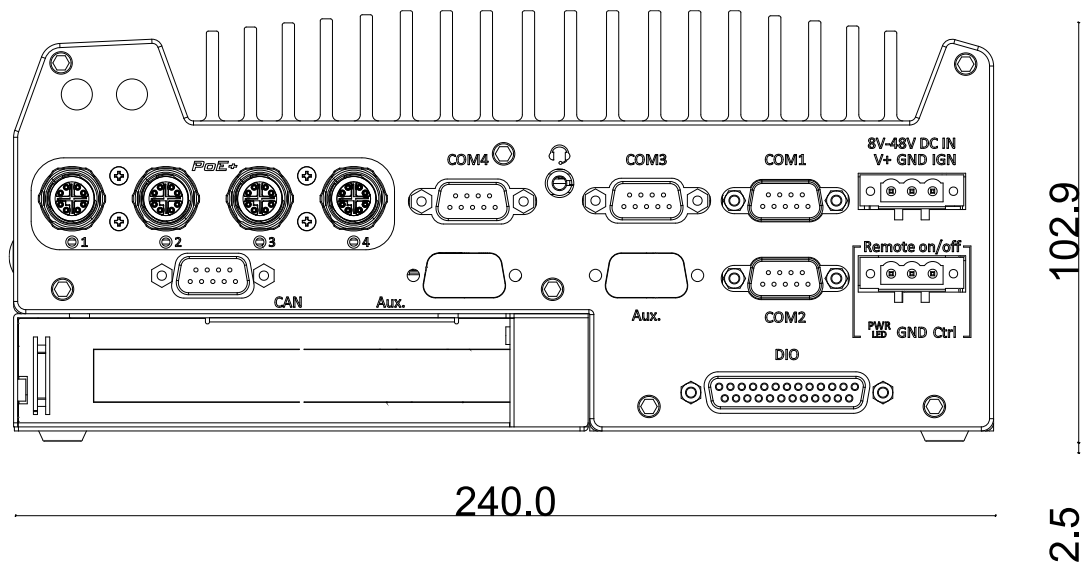

### 1.5.3 Nuvo-9200VTC Series Top View

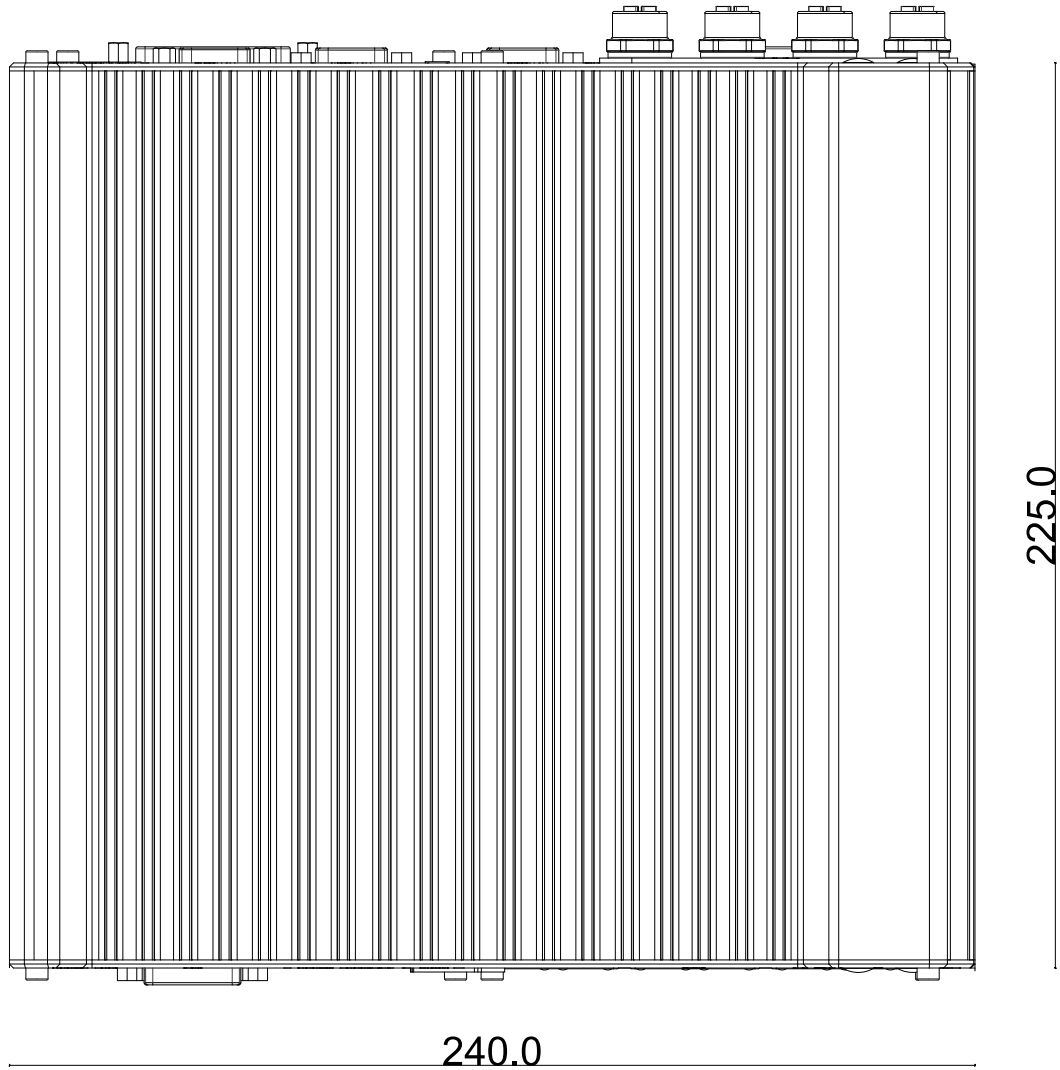

### 1.5.4 Nuvo-9200VTC Series Bottom View

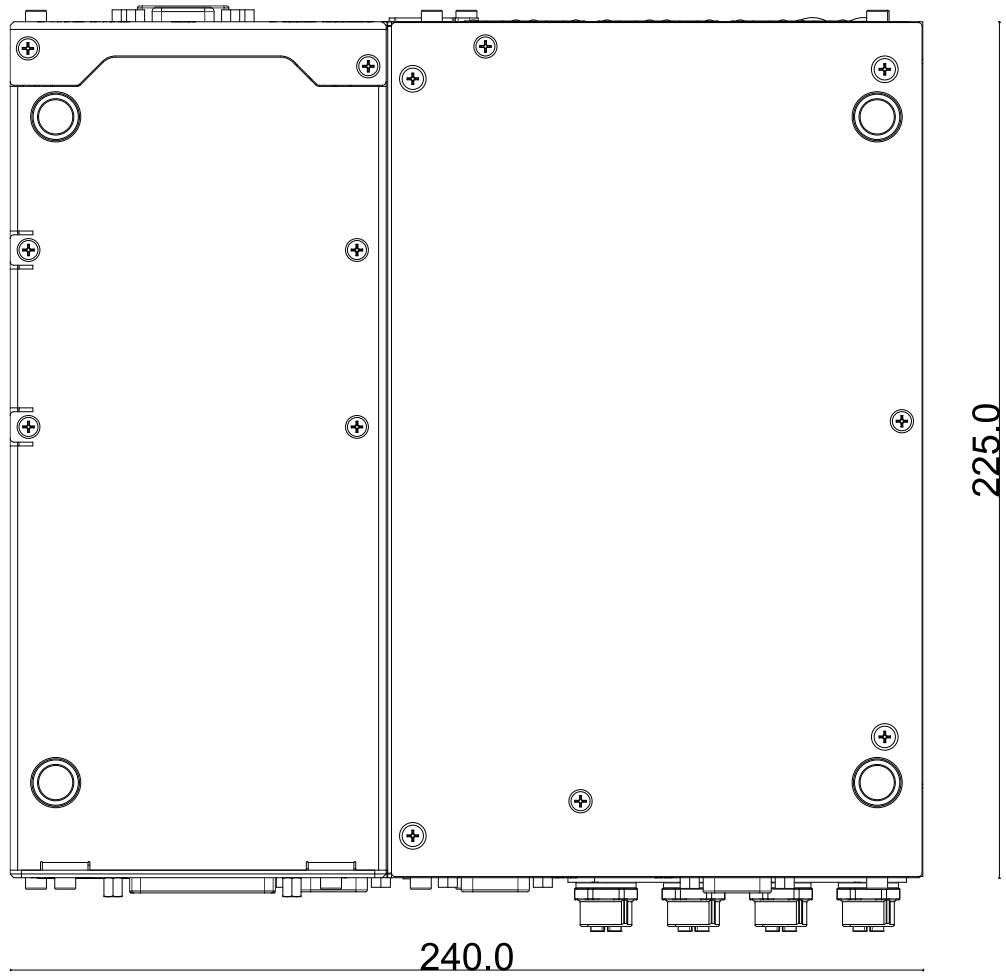

### 1.5.5 Nuvo-9200VTC Series with Damping Bracket

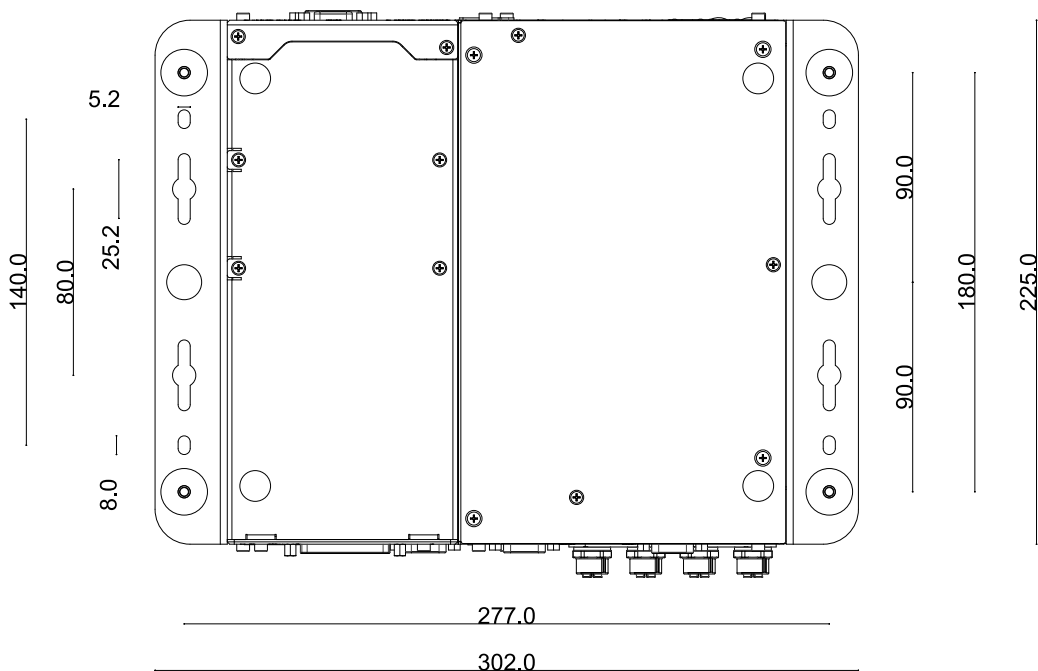



## 2 System Overview

Upon receiving and unpacking your Nuvo-9100VTC system, please check immediately if the package contains all the items listed in the following table. If any item(s) are missing or damaged, please contact your local dealer or Neosys Technology.

### 2.1 Packing List

#### 2.1.1 Nuvo-9100VTC Series Packing List

System Pack	Nuvo-9100VTC	Nuvo-9104VTC	Nuvo-9108VTC	Qty
1	Fanless in-vehicle controller/ computer (If you ordered CPU/ RAM/ HDD, please verify these items)			1
2	Accessory box, which contains <ul style="list-style-type: none"> <li>● CPU bracket</li> <li>● Damping bracket for in-vehicle deployment (with shock-absorbing grommets)</li> <li>● 3-pin power terminal block</li> <li>● Key for hot-swappable HDD tray</li> <li>● HDD thermal pad for 2.5" HDD/SSD (if HDD is not installed)</li> <li>● Screw pack</li> </ul>			1 1 1 1 1 1

#### 2.1.2 Nuvo-9200VTC Series Packing List

System Pack	Nuvo-9200VTC	Nuvo-9204VTC	Nuvo-9208VTC	Qty
1	Fanless in-vehicle controller/ computer (If you ordered CPU/ RAM/ HDD, please verify these items)			1
2	Accessory box, which contains <ul style="list-style-type: none"> <li>● CPU bracket</li> <li>● Damping bracket for in-vehicle deployment (with shock-absorbing grommets)</li> <li>● 3-pin power terminal block</li> <li>● Key for hot-swappable HDD tray</li> <li>● Screw pack</li> </ul>			1 1 1 1 1

## 2.2 Nuvo-9000VTC Series Front Panel I/O

Neosys Nuvo-9000VTC series front panel offer a variety of I/O ports. For demonstration purposes, Nuvo-9100VTC series will be used in most illustrations.

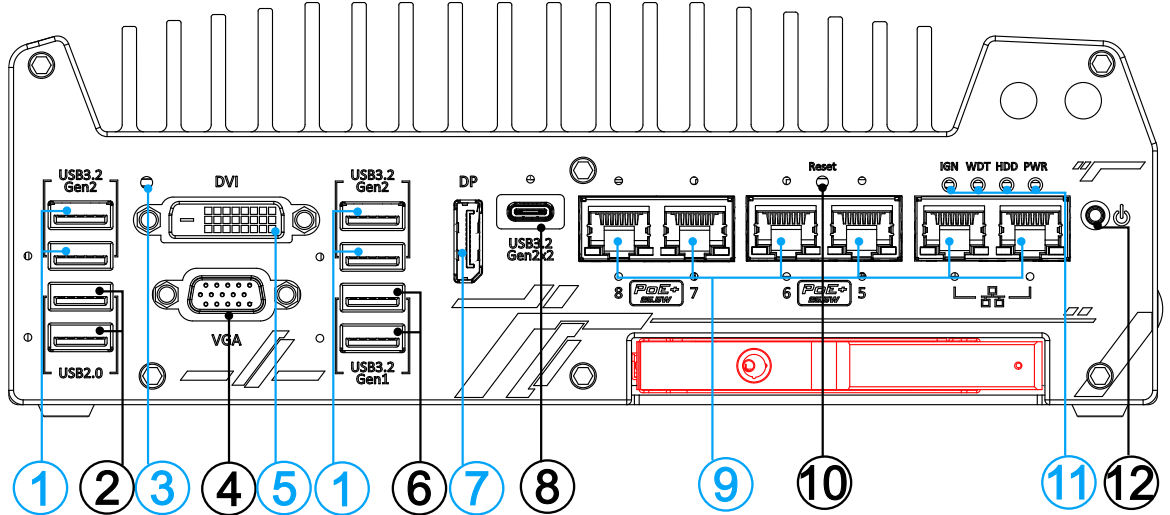

Nuvo-9100VTC Series Front Panel

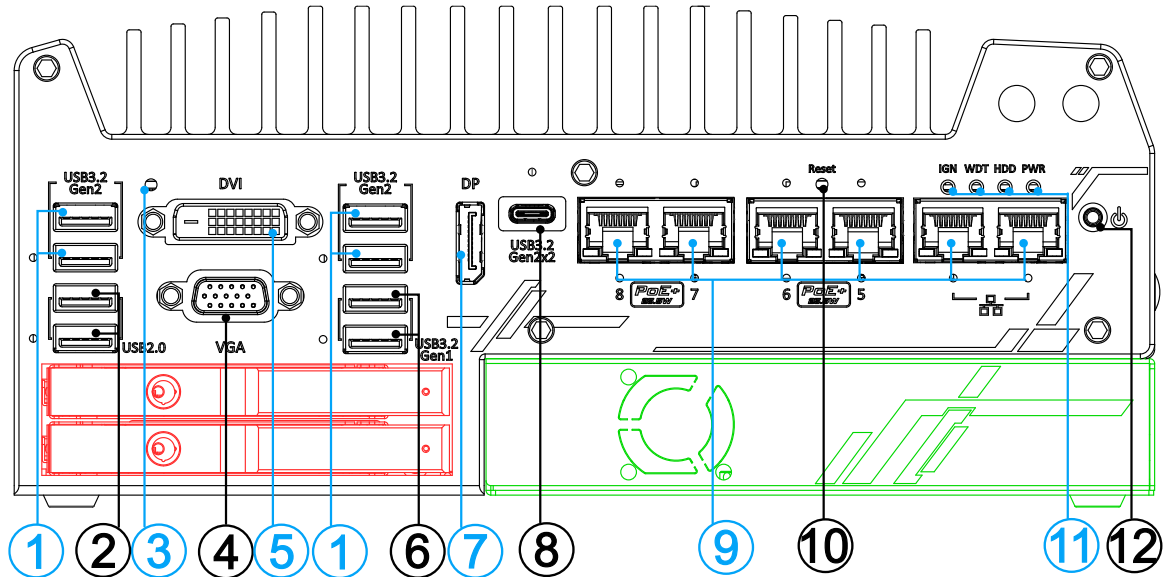

Nuvo-9200 Series Front Panel

No.	Item	Description
1	<a href="#">USB3.2 Gen2x1 port</a>	USB3.2 Gen 2 port (SuperSpeed+) offers up to 10Gbps, twice the bandwidth over existing SuperSpeed USB3.2 Gen. 1 connection. It is also backwards compatible with USB3.0 and USB2.0
2	<a href="#">USB2.0 port</a>	The USB 2.0 ports offer up to 480Mbit/s bandwidth and are backward compatible with USB 1.1/ 1.0
3	<a href="#">CMOS reset button</a>	Use this button to manually to reset the CMOS to load default BIOS

4	<a href="#">VGA port</a>	VGA output supports resolution up to 1920 x 1200@60Hz
5	<a href="#">DVI port</a>	DVI-D output supports resolution up to 1920 x 1200@60Hz and is compatible with other digital connections via an adapter
6	<a href="#">USB3.1 Gen1x1 port</a>	USB3.1 Gen 1 offers up to 5Gbps of data-throughput performance
7	<a href="#">DisplayPort</a>	Support display resolutions up to 4096 x 2304 @ 60Hz. Compatible with HDMI/ DVI via respective adapter/ cable (resolution may vary)
8	<a href="#">USB3.2 Gen2x2 Type-C port</a>	The USB 3.2 Gen2x2 type-C port offers up to 20Gbps of bandwidth connectivity for fast data exchange with external devices
9	<a href="#">Ethernet &amp; PoE+ port</a>	1x 2.5GbE by I225 and 1x GbE by I219 with screw-lock Additional 4x 2.5GbE by I225 (Nuvo-9108/ 9208VTC) with screw-lock
10	<a href="#">Reset button</a>	Use this button to manually reset the system
11	<a href="#">Status LED indicators</a>	From left to right, the LEDs are IGN (ignition control), WDT (watchdog timer), HDD (hard disk drive) and PWR (system power)
12	<a href="#">Power button</a>	Use this button to turn on or shutdown the system
<b>Area in Green</b>	Cassette module	The cassette module offers a separate compartment to manage thermal conditions and reduce installation complications of an add-on card
<b>Area in Red</b>	2.5" HDD/SSD Tray	The HDD expansion tray offer hot-swap ability (1x tray for Nuvo-9100VTC systems and 2x trays for Nuvo-9200VTC systems)

### 2.2.1 USB3.2 Gen2x1 Port

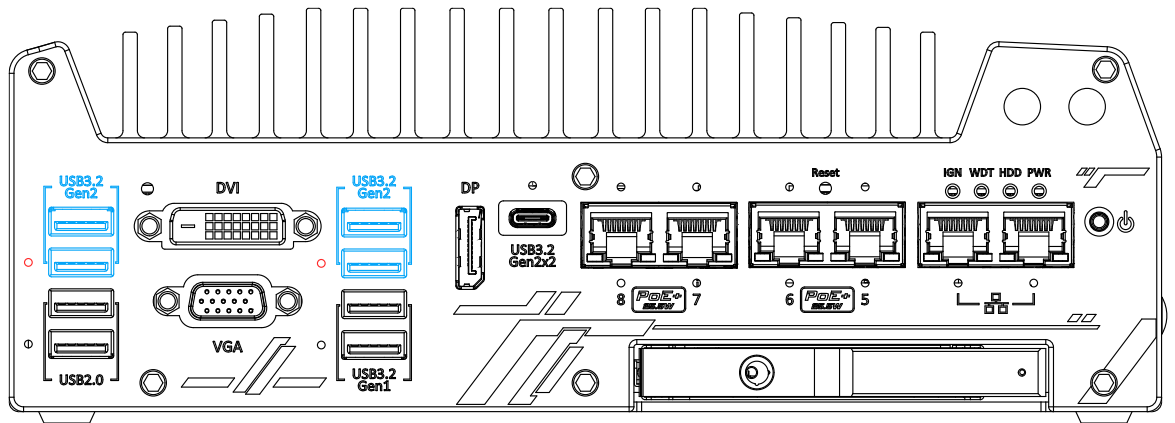

The system's USB 3.2 Gen2x1 ports (10Gbps) are implemented via native xHCI (eXtensible Host Controller Interface) controller and are backward compatible with USB3.2 Gen1, USB 2.0, USB 1.1 and USB 1.0 devices. UEFI USB is also supported so you can use USB keyboard/ mouse in UEFI shell environment. Indicated in **red** are screw-lock holes for the corresponding USB port. xHCI driver is supported natively in Windows 10, therefore you do not need to install the xHCI driver prior to utilizing USB functions.

### 2.2.2 USB2.0 Port

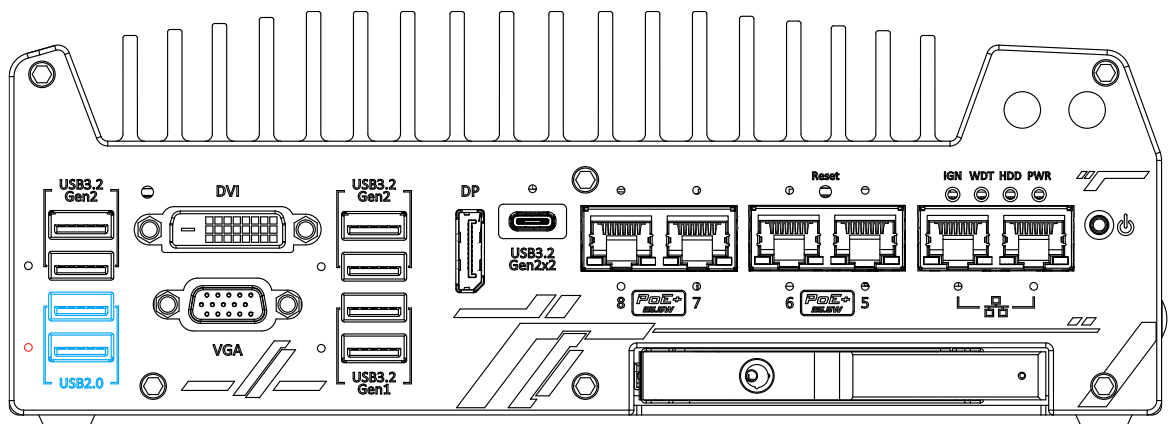

The USB2.0 ports are implemented via native xHCI (eXtensible Host Controller Interface) and are backward compatible with USB 1.1 and USB 1.0 devices. UEFI USB support is also provided so you can use USB keyboard/ mouse in UEFI shell environment. Indicated in **red** is a screw-lock hole for the corresponding USB port.

xHCI driver is supported natively in Windows 10, therefore you do not need to install xHCI driver to utilize USB functions.

### 2.2.3 CMOS Reset Button

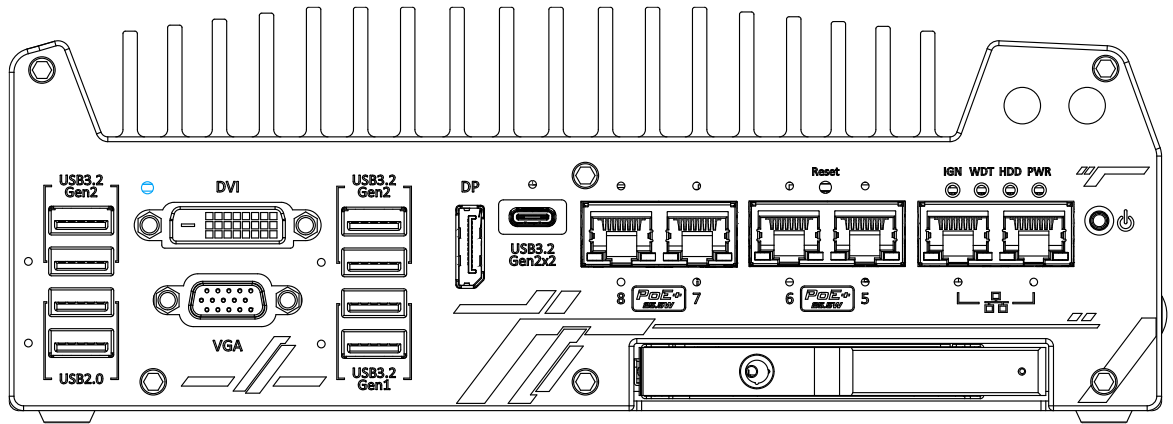

The CMOS Reset button is used to manually reset the motherboard BIOS in case of system halt or malfunction. To avoid unexpected operation, it is purposely placed behind the panel. To reset, disconnect the DC power input, and use the tip of a pen to press and hold for at least 5 seconds to reset the BIOS.



You **MUST** disconnect the DC input from the system before resetting the CMOS.



Clearing the CMOS will reset all BIOS settings to default and may result in down time!

## 2.2.4 VGA Port

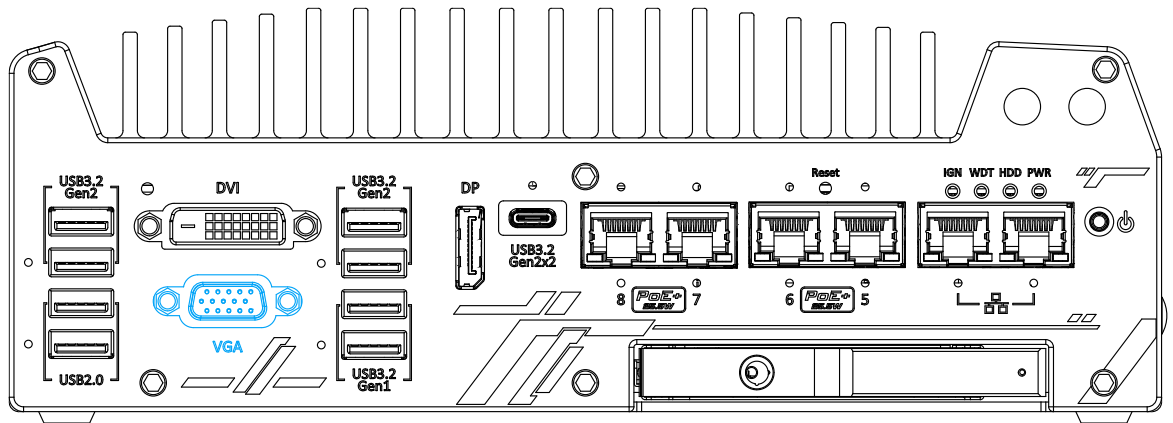

VGA connector is the most common video display connection. The VGA output supports up to 1920x1200@60Hz resolution.

The system supports triple independent display outputs by connecting display devices to VGA, DVI and DisplayPort connection. To support multiple display outputs and achieve best VGA output resolution in Windows, you need to install corresponding graphics drivers. Please refer to section [OS Support and Driver Installation](#) for details.



### NOTE

*Please make sure your VGA cable includes SDA and SCL (DDC clock and data) signals for correct communication with monitor to get resolution/timing information. A cable without SDA/ SCL can cause blank screen on your VGA monitor due to incorrect resolution/timing output.*

### 2.2.5 DVI Port

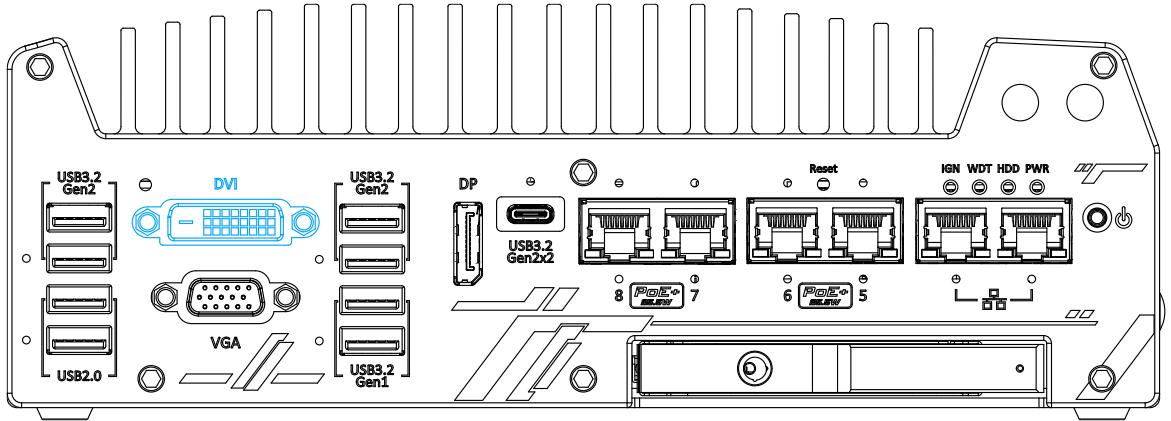

DVI-D transmits graphics data in digital format and therefore can deliver better image quality at high resolution. The DVI connector on the front panel can either output DVI signals or other digital signals (via an adapter/ cable) depending on the display device connected. It supports resolutions up to 1920x1200@60Hz.

The system supports triple independent display outputs by connecting display devices to VGA, DVI and DisplayPort connection. To support multiple display outputs and achieve best DVI output resolution in Windows, you need to install corresponding graphics driver. Please refer to section [OS Support and Driver Installation](#) for details.

### 2.2.6 USB3.2 Gen1x1 Port

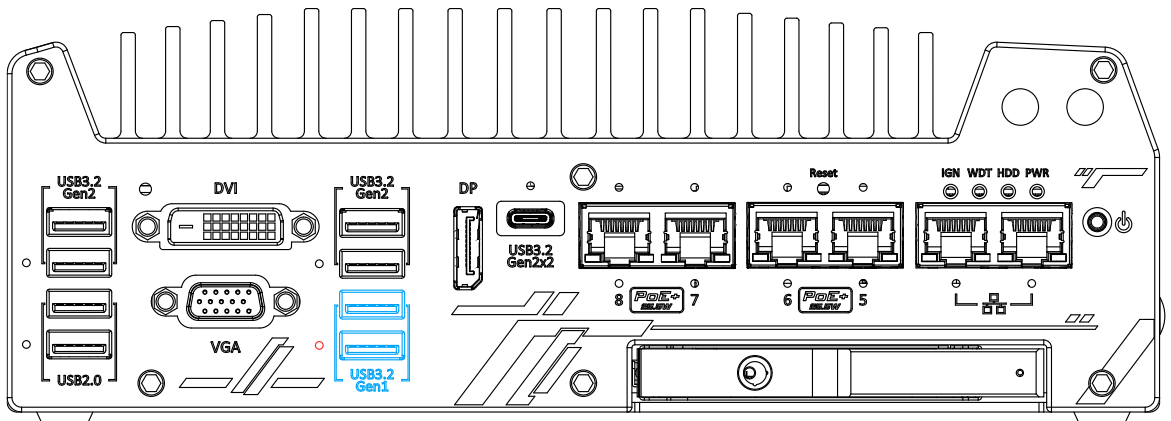

The system's USB 3.2 Gen1x1 ports (5Gbps) are implemented via native xHCI (eXtensible Host Controller Interface) controller and are backward compatible with USB 2.0, USB 1.1 and USB 1.0 devices. UEFI USB is also supported so you can use USB keyboard/mouse in UEFI shell environment. Indicated in **red** is a screw-lock hole for the corresponding USB port. xHCI driver is supported natively in Windows 10, therefore you do not need to install the xHCI driver prior to utilizing USB functions.

## 2.2.7 DisplayPort

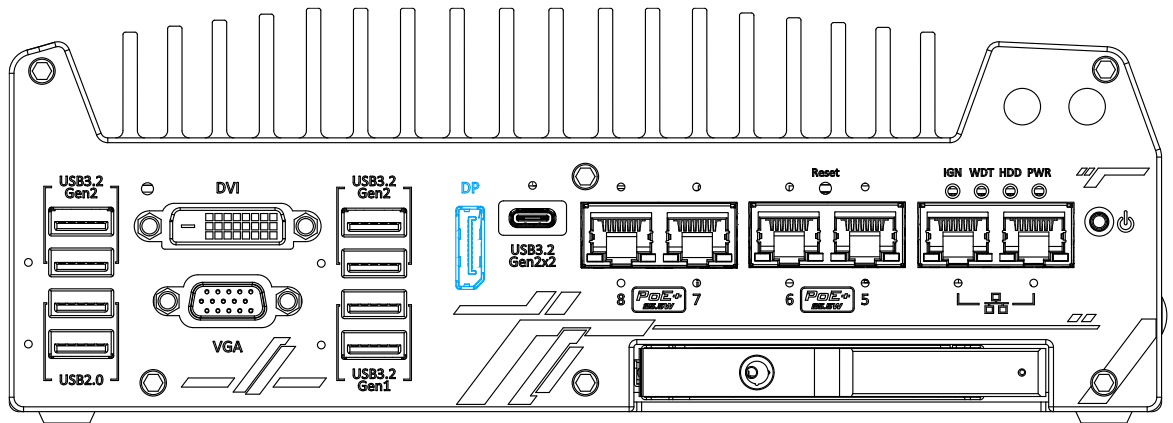

The system has a DisplayPort (DP) output which is a digital display interface that mainly connect video source and carry audio to a display device. When connecting a DP, it can deliver up to 4K UHD (4096 x 2304 @ 60Hz) in resolution. The system is designed to support passive DP adapter/ cable. You can connect to other display devices using DP-to-HDMI cable or DP-to-DVI cable.



**DP-to-HDMI**



**DP-to-DVI**

The system supports triple independent display outputs by connecting display devices to VGA, DVI and DisplayPort connection. To support multiple display outputs and achieve best DisplayPort output resolution in Windows, you need to install corresponding graphics drivers. Please refer to section [OS Support and Driver Installation](#) for details.



## 2.2.8 USB3.2 Gen2x2 Type-C Port

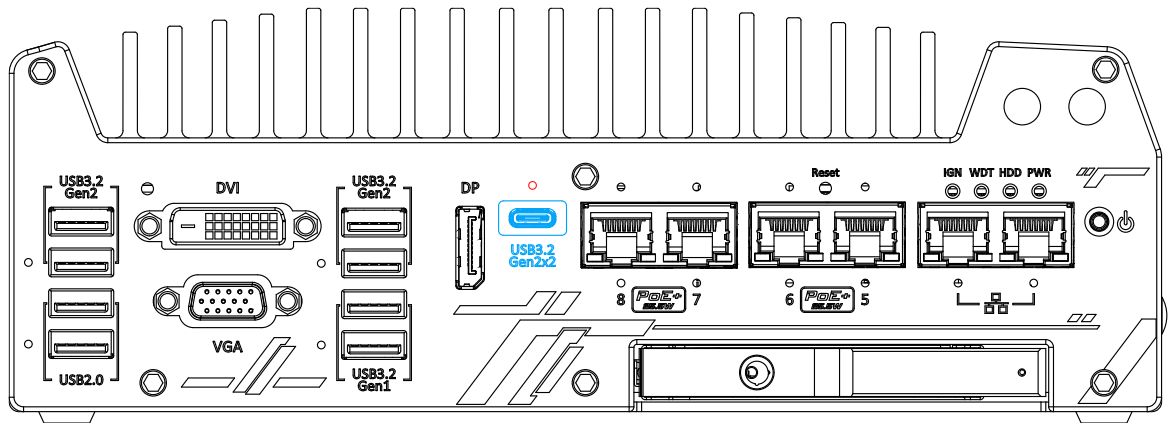

The system's USB 3.2 Gen2x2 type-C port offers up to 20Gbps of data transfer bandwidth, and is implemented via the native xHCI (eXtensible Host Controller Interface) controller. Indicated in **red** is a screw-lock hole for the corresponding USB port.

The port is backward compatible with USB3.2 Gen1, USB 2.0, USB 1.1 and USB 1.0 devices via a USB hub (not included) to connect to external devices.

xHCI driver is supported natively in Windows 10, therefore you do not need to install the xHCI driver prior to utilizing USB functions.

## 2.2.9 2.5 Ethernet Port/ Optional PoE+

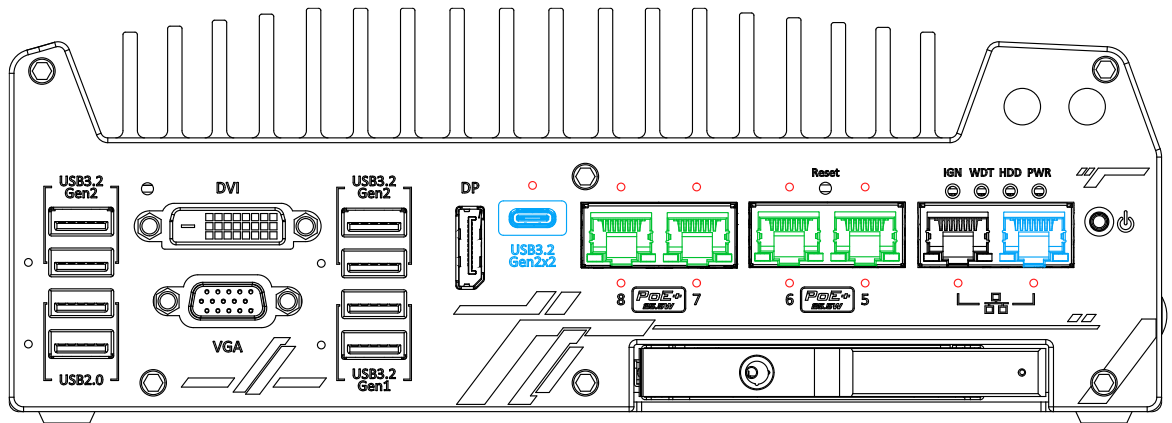

All Nuvo-9000VTC series systems offer one 2.5GbE port (in **black**) and one GbE port (in **blue**) while Nuvo-9108/ 9208VTC systems have four additional 2.5GbE (with optional Power over Ethernet) ports marked in **green** on the front panel. All Ethernet ports feature panel screw fix holes for a firm connection (indicated in **red**). The port marked in **blue** is implemented using Intel® I219-LM controller that supports Wake-on-LAN and is also compatible with [Intel® AMT \(Active Management Technology\)](#) to support advanced features such as remote SOL desktop and remote on/ off control. There are panel screw fix holes (indicated in **red**) for a firm and secure connection. Power over Ethernet (PoE) supplies electrical power and data on a standard CAT-5/CAT-6 Ethernet cable. Acting as a PoE PSE (Power Sourcing Equipment), compliant with IEEE 802.3at, each PoE port (indicated in **green**) delivers up to 25W to a Powered Device (PD). The system has a total 100W power budget. PoE ports can automatically detect and determine if the connected device requires power or not, so it is compatible with standard Ethernet devices as well. Each port has one dedicated PCI Express link for maximum network performance. Please refer to the table below for LED connection statuses.

### Active/Link LED (Right)

LED Color	Status	Description
Orange	Off	Ethernet port is disconnected
	On	Ethernet port is connected and no data transmission
	Flashing	Ethernet port is connected and data is transmitting/receiving

### Speed LED (Left)

LED Color	Status	Description
Green or Orange	Off	10 Mbps
	Green	100 Mbps
	Orange	1000/ 2500 Mbps

To utilize the Ethernet ports in Windows, you need to install corresponding driver for Intel® I225 and I219-LM controllers.

### 2.2.10 Reset Button

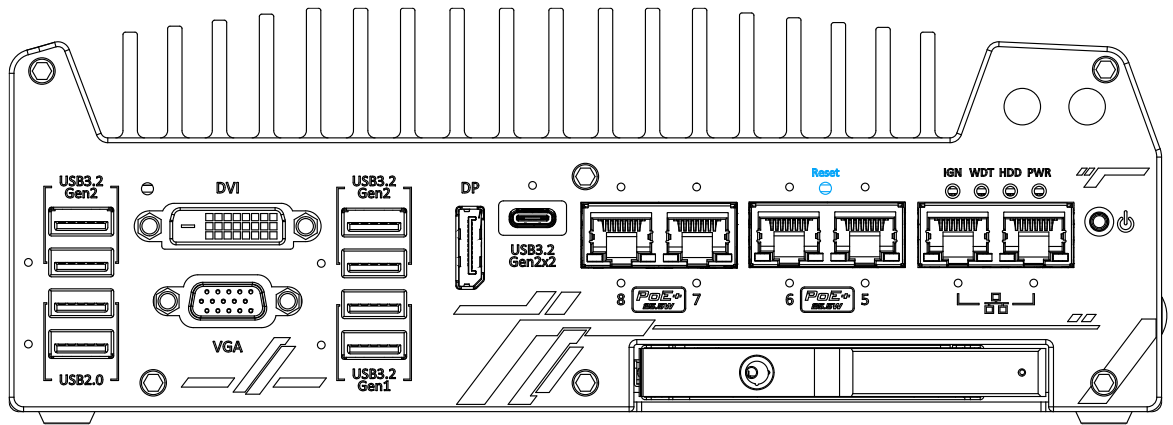

The reset button is used to manually reset the system in case of system halt or malfunction. To avoid unexpected reset, the button is purposely placed behind the panel. To reset, please use a pin-like object (eg. tip of a pen) to access the reset button

### 2.2.11 LED Indicators

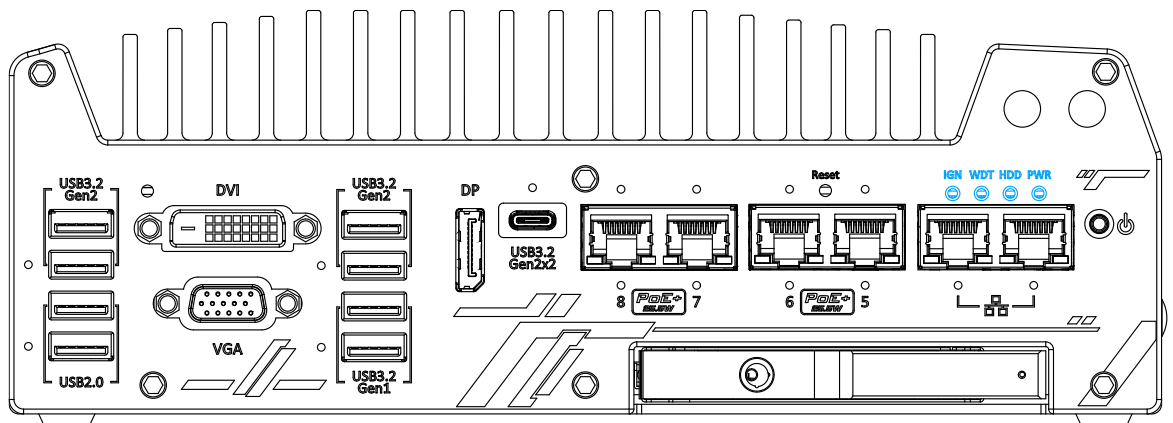

There are four LED indicators on the I/O panel: IGN, WDT, HDD and PWR. The descriptions of these four LED are listed in the following table.

Indicator	Color	Description
IGN	Yellow	Ignition signal indicator, lid when IGN is high (12V/ 24V).
WDT	Yellow	Watchdog timer LED, flashing when WDT is active.
HDD	Red	Hard drive indicator, flashing when hard disk drive is active.
PWR	Green	Power indicator, lid when system is on.

### 2.2.12 Power Button

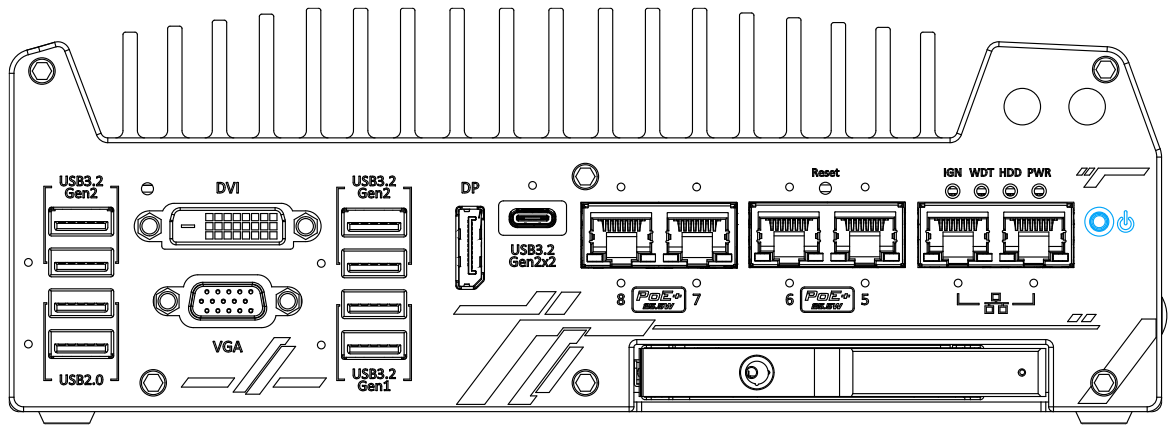

The power button is a non-latched switch for ATX mode on/off operation. To turn on the system, press the power button and the PWR LED should light-up green. To turn off the system, issuing a shutdown command in OS is preferred, or you can simply press the power button. To force shutdown when the system freezes, press and hold the power button for 5 seconds. Please note that there is a 5-second interval between on/off operations (i.e. once the system is turned off, there is a 5-second wait before you can power-on the system).

### 2.2.13 Hot-swappable 2.5” HDD/ SSD Slot

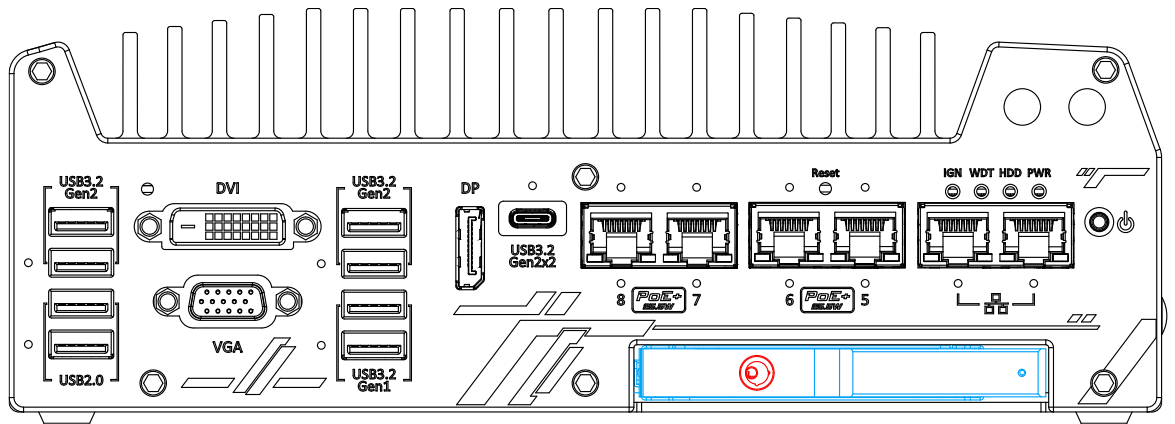

The Nuvo-9100VTC systems support an external 2.5” HDD/ SSD via a hot-swappable slot. Designed for easy access, the HDD/ SSD slot is secured by a lock (indicated in red) and it supports RAID modes 0/ 1 configuration by combining with the internal HDD/ SSD drive for OS installation (coupled with the internal HDD). To set up RAID, please refer to RAID Volume Configuration section for details.

### 2.2.14 Cassette Module

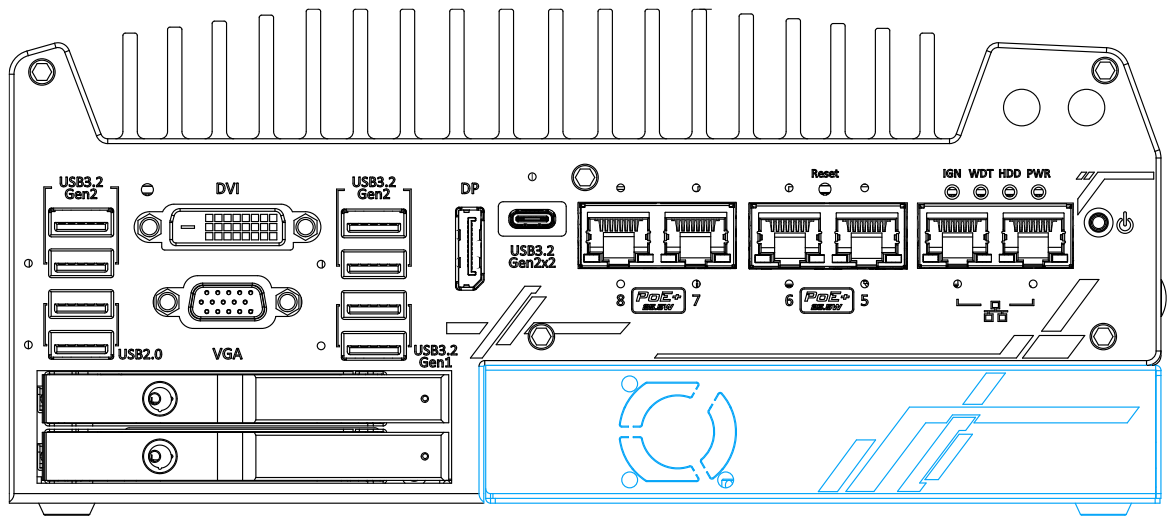

Neosys' patented expansion Cassette (R.O.C. Patent No. M456527) provides a separated compartment to accommodate an add-on card. It effectively manages thermal conditions of both the system and the add-on card. The modular concept brought by Cassette module also reduces the complexity of installing and replacing an add-on card in the fanless controller.

However, in the event that an add-on card generates excessive heat, there is an optional fan, measuring 25 x 25 x10mm, that can be installed into the Cassette module to draw in cold air or draw out warm air.

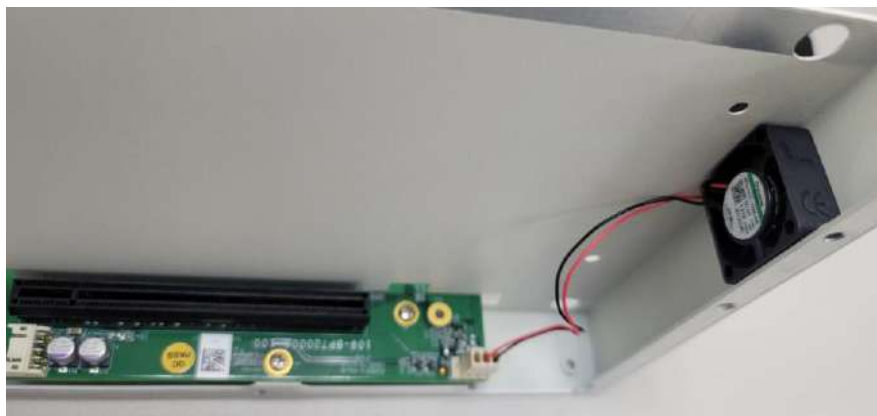

**Optional fan kit**

## 2.3 Nuvo-9000VTC Series Rear Panel I/O

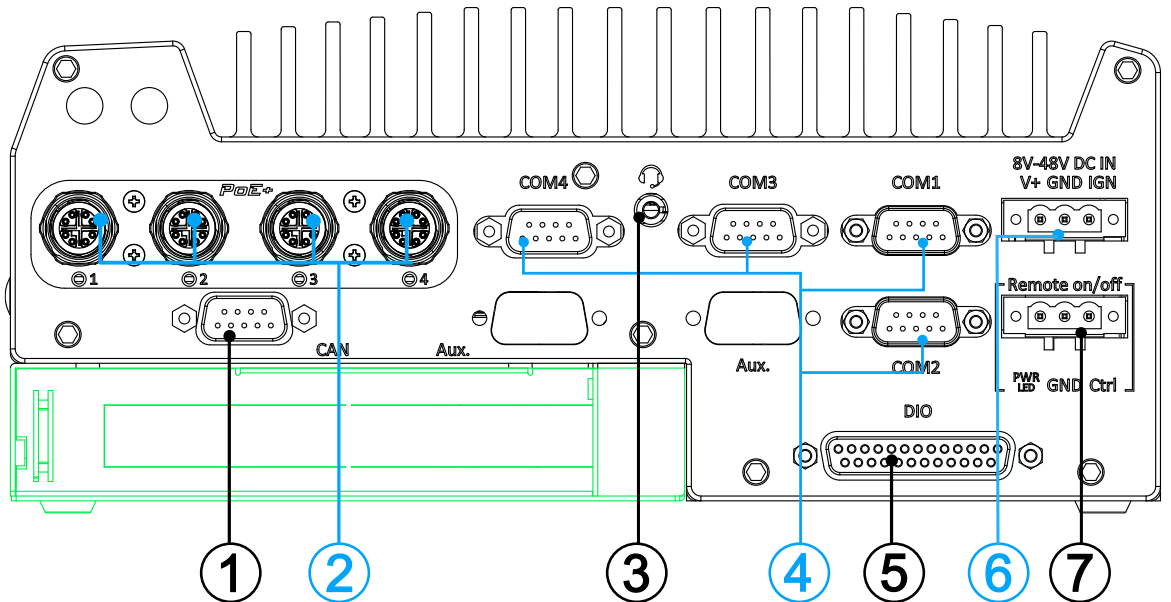
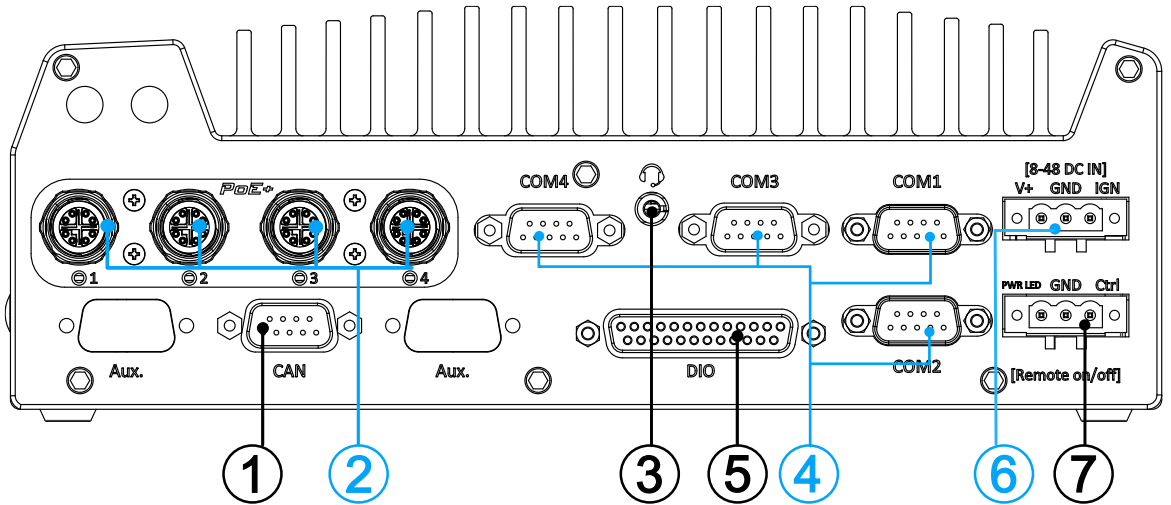

The rear panel features four RJ45 or M12 PoE ports, CAN bus, digital I/O, four COM ports, ignition control switch, 3-pin terminal and remote 3-pin on/ off control.

No.	Item	Description
1	CAN bus	Allows controller to communicate with other in-vehicle CAN device(s).
2	PoE+ GbE port	<b>M12</b> x-coded connector is applicable to Nuvo-9100/ 9200VTC systems. The rugged connection guarantees signal integrity while providing both data and electric power to devices.

		<b>RJ45 Ethernet</b> is applicable to Nuvo-9104/ 9204/ 9108/ 9208VTC systems. The Power over Ethernet (PoE) port can provide both data connection and electric power to devices.
<b>3</b>	Headphone/ microphone jack	The 4-pole 3.5mm jack accepts microphone voice input and headphone speaker sound output.
<b>4</b>	COM ports 1-4	The four COM ports offer communication with external devices.
<b>5</b>	Digital I/O	The DIO port provides 4x isolated digital input and 4x isolate output channels.
<b>6</b>	3-pin terminal block (DC/ ignition input)	Compatible with DC power input from 8V to 48V, the terminal block is also used for ignition signal input.
<b>7</b>	3-pin remote on/ off control	Allows for external switch extension when the system is placed inside a cabinet.
<b>Area in green</b>	Cassette module	The cassette module offers a separate compartment to manage thermal conditions and reduce installation complications of an add-on card.  Nuvo-9200VTC series features 1x PCIe x16 slot@Gen.3 (16-lanes) for add-on card expansion.

### 2.3.1 CAN bus Port

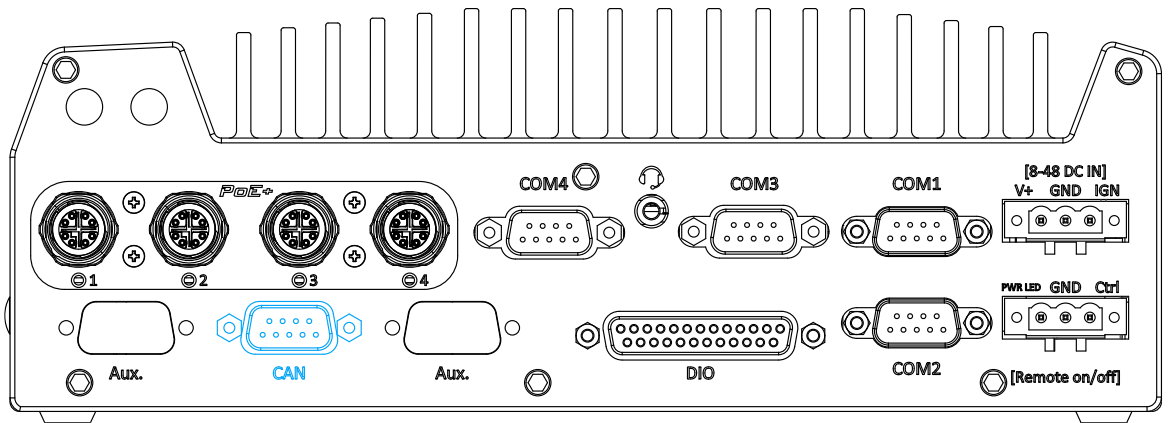

CAN bus is a robust industrial bus with a pair of differential signals and is commonly used in various industrial and in-vehicles applications. The system is equipped with a CAN bus DB9 port that is compatible with both industrial and in-vehicle applications. The CAN bus port supports CAN2.0A and CAN2.0B up to 1Mbps.

#### CAN bus Port Pin Definition

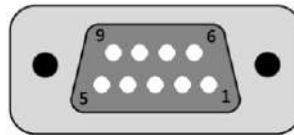

Pin No.	Definition	I/O	Description
1	GND	-	GND
2	Reserved	-	Reserved pin. Keep unconnected
3	CAN_H	I/O	CAN Bus High-level voltage
4	Reserved	-	Reserved pin. Keep unconnected
5	CAN_L	I/O	CAN Bus Low-level voltage
6	Reserved	-	Reserved pin. Keep unconnected
7	Reserved	-	Reserved pin. Keep unconnected
8	Reserved	-	Reserved pin. Keep unconnected
9	Reserved	-	Reserved pin. Keep unconnected



### 2.3.2 M12 Power over Ethernet Port (Nuvo-9100/ 9200VTC)

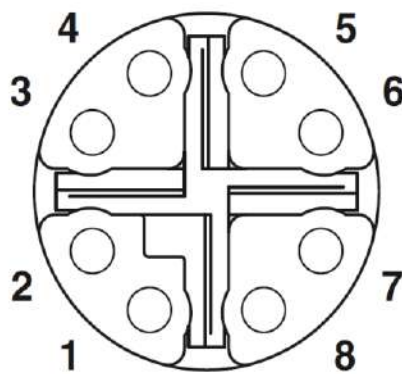
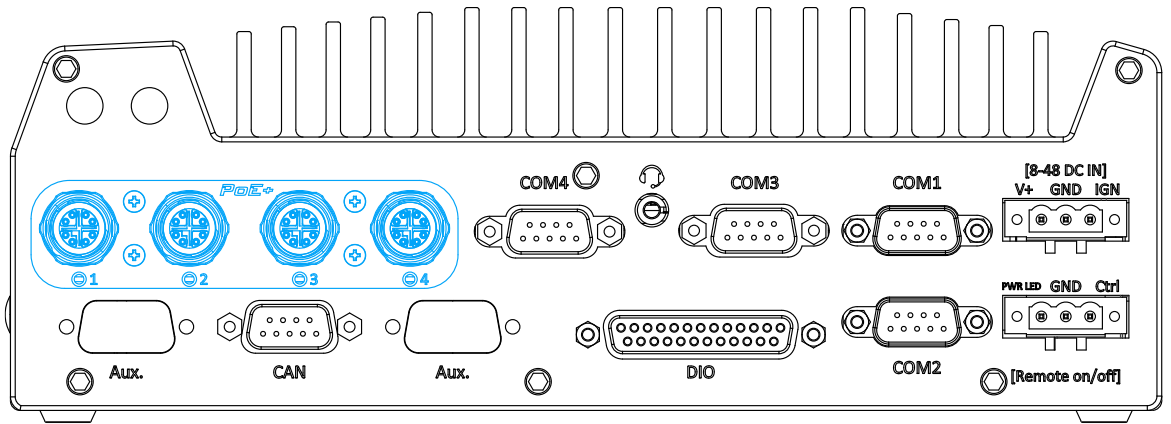



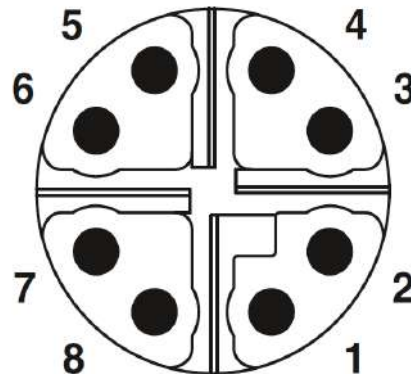





M12 socket (panel side)



M12 plug (cable side)

#### M12 Pin and Corresponding RJ45 Wire Connection

Wire color	Signal	M12 Pin	RJ45 Wire
	D1+	1	1
	D1-	2	2
	D2+	3	3
	D3+	8	4
	D3-	7	5
	D2-	4	6
	D4+	5	7
	D4-	6	8

PoE ports are provided via 8-pole, x-coded M12 connectors, offering extraordinary reliability for Ethernet connection. Power over Ethernet (PoE) supplies electrical power along with data on a standard Ethernet cable. As an IEEE 802.3at compliant PSE (Power Sourcing Equipment), each PoE port can deliver up to 25W of power to a Powered Device (PD), such as an IP camera. PoE is able to automatically detect the device connected and determine whether to dispatch power thus it is also compatible with traditional Ethernet devices.

### 2.3.3 RJ45 Power over Ethernet Port (Nuvo-9104/ 9204/ 9108/ 9208TC)

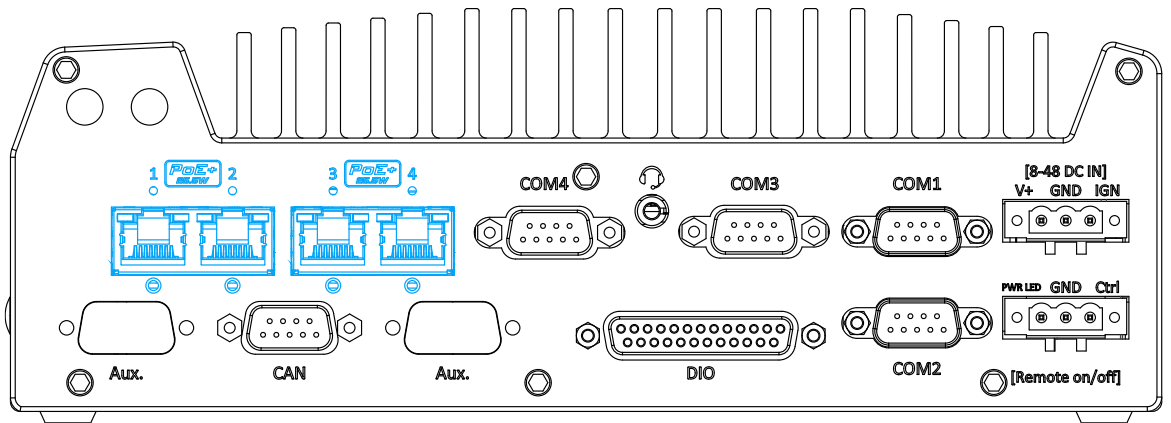

PoE ports are provided via RJ-45 connectors. Power over Ethernet (PoE) is an Ethernet technology that supplies electrical power along with data on a standard CAT-6 Ethernet cable. Acting as a Power Source Equipment (PSE), compliant with IEEE 802.3at standard, each port can deliver up to 25W of power to a Powered Device (PD), such as a PoE IP camera. PoE is able to automatically detect the device connected and determine whether to dispatch power thus it is also compatible with traditional Ethernet devices. Each port is linked to a dedicated PCI Express for maximum network performance. When plugged in, the Ethernet connection status and speed are shown on RJ45 LED indicators.

#### Active/Link LED

LED Color	Status	Description
Yellow	Off	Ethernet port is disconnected
	On	Ethernet port is connected and no data transmission
	Flashing	Ethernet port is connected and data is transmitting/receiving

#### Speed LED

LED Color	Status	Description
Green or Orange	Off	10 Mbps
	Green	100 Mbps
	Orange	1000 Mbps

### 2.3.4 Digital Input/ Output

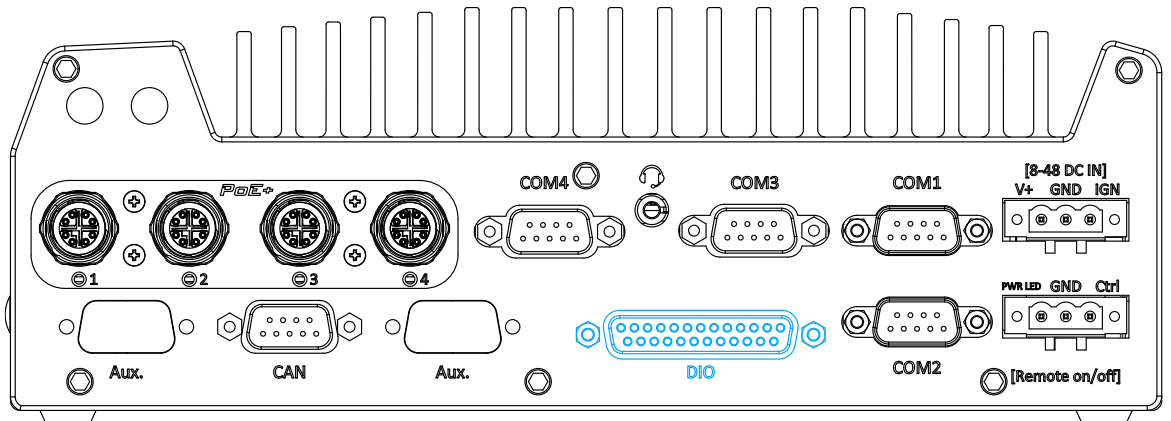

The system provides 4x isolated digital input channels and 4x isolated digital output channels. The DIO functions support polling mode I/O access and DI change-of-state interrupt. Please refer to digital I/O pin definition on the following page and [Watchdog Timer & Isolated DIO](#) for information on wiring and programming the isolated DIO channels.

#### Digital I/O Pin Definition

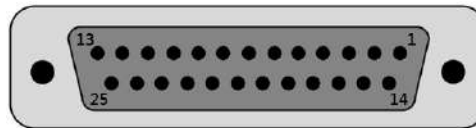

Pin No.	Definition	I/O	Description
1	ISO_DI3H	I	Digital input channel 3
2	ISO_DI2H	I	Digital input channel 2
3	ISO_DI1H	I	Digital input channel 1
4	ISO_DI0H	I	Digital input channel 0
5	Reserved	-	Reserved pin. Keep unconnected
6	Reserved	-	Reserved pin. Keep unconnected
7	ISO_DO3	O	Digital output channel 3
8	ISO_DO2	O	Digital output channel 2
9	ISO_DO1	O	Digital output channel 1
10	ISO_DO0	O	Digital output channel 0
11	VDD	-	DO voltage source input for inductive load
12	Reserved	-	Reserved pin. Keep unconnected
13	Reserved	-	Reserved pin. Keep unconnected
14	ISO_DI3L	-	Digital input channel 3 GND
15	ISO_DI2L	-	Digital input channel 2 GND
16	ISO_DI1L	-	Digital input channel 1 GND
17	ISO_DI0L	-	Digital input channel 0 GND
18	Reserved	-	Reserved pin. Keep unconnected
19	Reserved	-	Reserved pin. Keep unconnected

20	DO_GND	O	Digital output ground
21	DO_GND	O	Digital output ground
22	DO_GND	O	Digital output ground
23	DO_GND	O	Digital output ground
24	DO_GND	O	Digital output ground
25	Reserved	-	Reserved pin. Keep unconnected

### 2.3.5 COM Ports

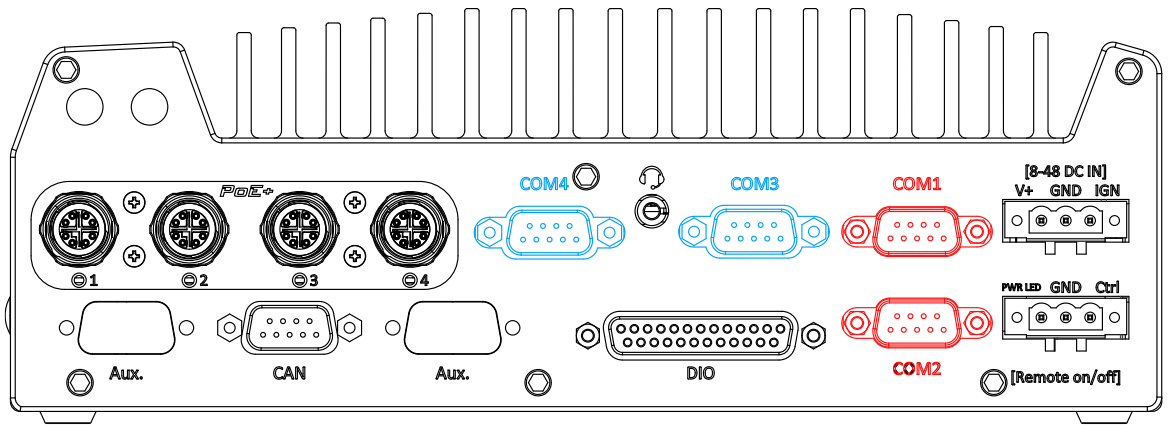

The system provides four COM ports for communicating with external devices. These COM ports are implemented using industrial-grade ITE8786 Super IO chip (-40 to 85°C) and provide up to 115200 bps baud rate.

COM1 and COM2 (in red) are software-configurable RS-232/ 422/ 485 ports. COM3 and COM4 (in blue) are standard 9-wire RS-232 ports. The operation mode of COM1 and COM2 can be set in BIOS setup utility. The following table describes the pin definition of COM ports.

#### COM Port Pin Definition

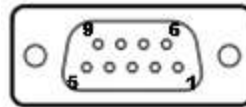

Pin#	COM1 & COM2			COM3 & COM4
	RS-232 Mode	RS-422 Mode	RS-485 Mode (Two-wire 485)	RS-232 Mode
1	DCD			DCD
2	RX	422 TXD+	485 TXD+/RXD+	RX
3	TX	422 RXD+		TX
4	DTR	422 RXD-		DTR
5	GND	GND	GND	GND
6	DSR			DSR
7	RTS			RTS
8	CTS	422 TXD-	485 TXD-/RXD-	CTS
9	RI			RI

### 2.3.6 3-Pin Terminal Block for DC and Ignition Input

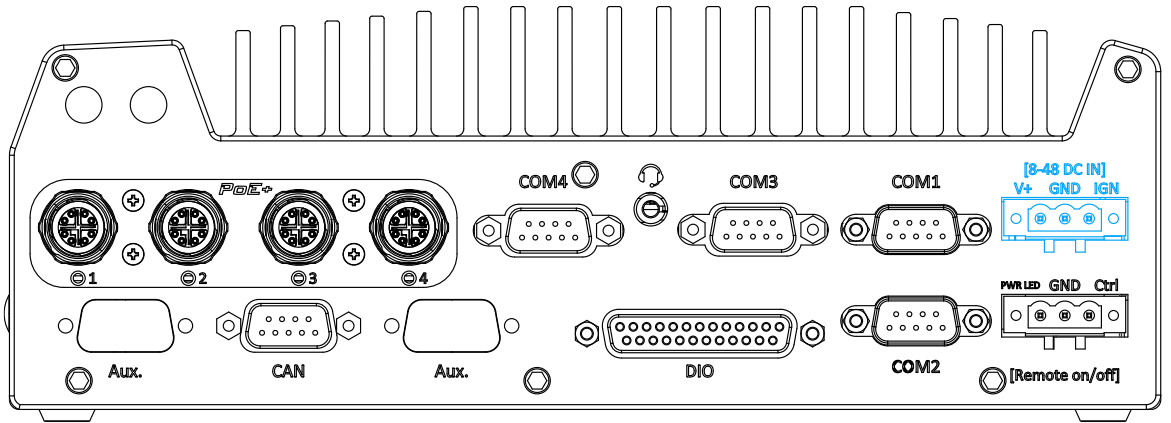

The system accepts a wide range of DC power input from 8 to 48V via a 3-pin pluggable terminal block, which is fit for field usage where DC power is usually provided. The screw clamping mechanism on the terminal block offers connection reliability when wiring DC power.

In addition to DC power input, this terminal block can also accept ignition signal input (IGN) for in-vehicle applications.

 **WARNING**

*Please make sure the voltage of DC power is correct before you connect it to the system. Supplying a voltage over 48V will damage the system.*

### 2.3.7 3-Pin Remote On/ Off

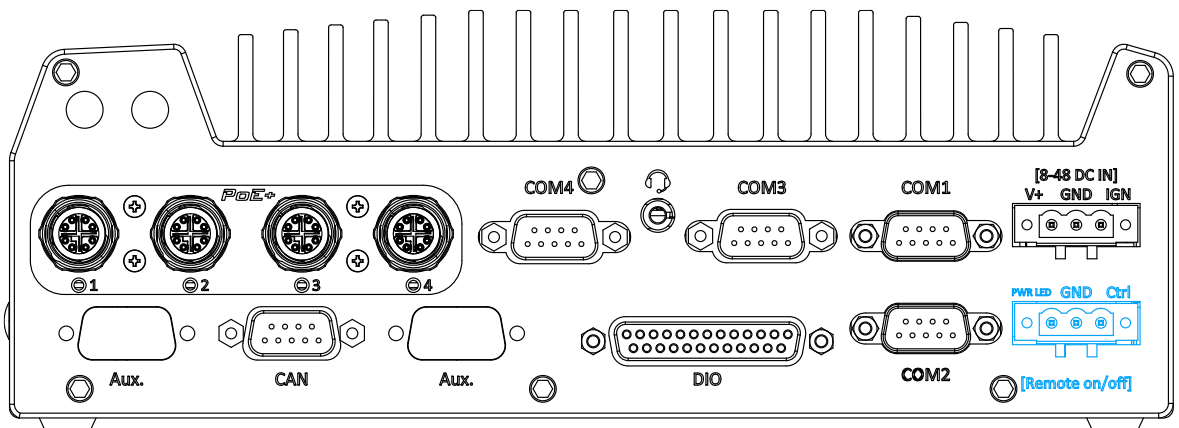

The “Remote On/ Off” 3-pin connection allows for external switch extension. It is useful when the system is placed in a cabinet or a not easily accessed location. You may connect an external status LED (20mA) indicator by connecting to PWR LED and GND.



## 2.4 Internal I/O Functions

In addition to I/O connectors on the front panel, the system also provides internal on-board connectors, such as remote on/off control, LED status output, internal USB 2.0 ports, etc. In this section, we'll illustrate these internal I/O functions.

### 2.4.1 Dual SODIMM DRAM Slot

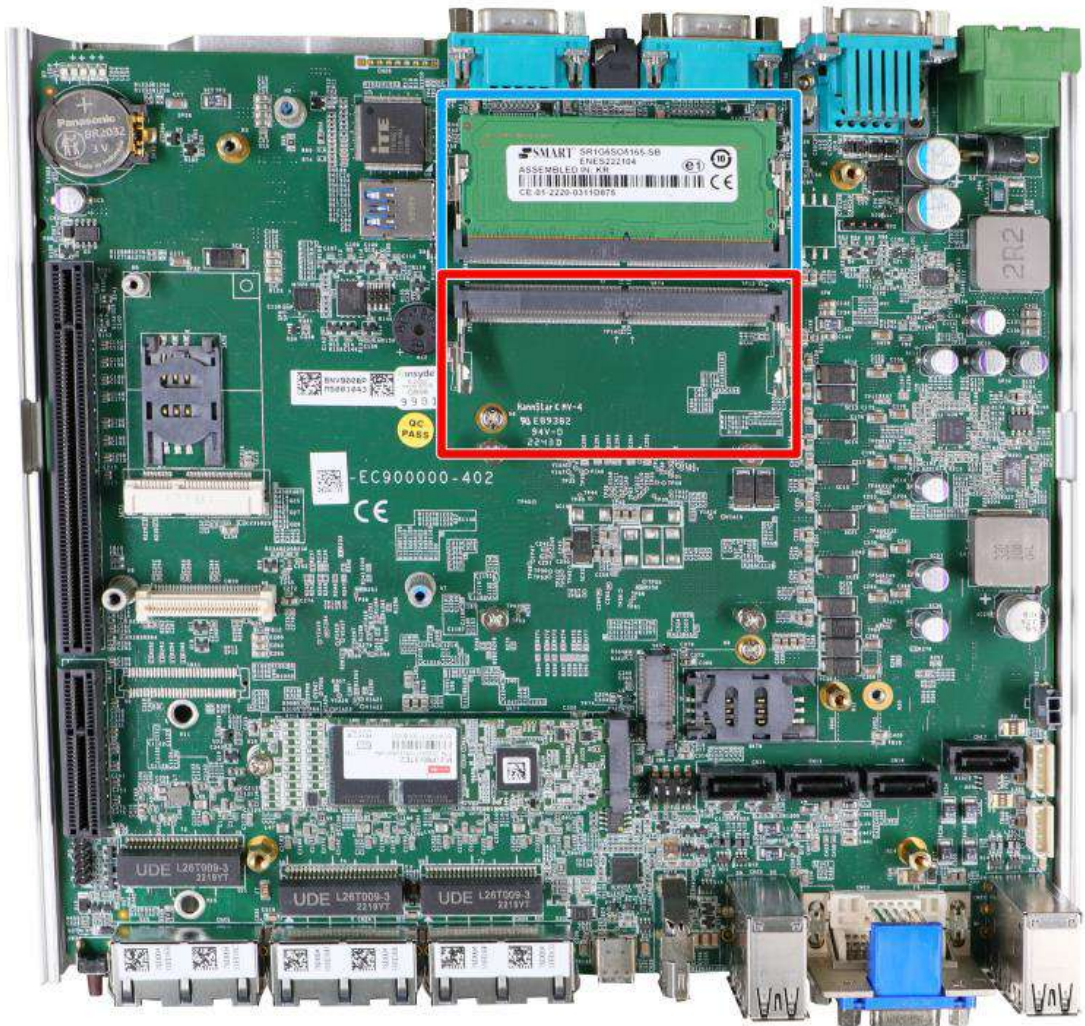

The system motherboard supports two DDR5 4800 SODIMMs memory module up to 64GB. Each slot supports single module SODIMM up to 32GB capacity. If you are installing a memory module, please install into the slot indicated in **blue**. When both slots are occupied, it is recommended that the operating ambient temperature does not exceed 60°C to avoid thermal throttling.



#### NOTE

*When changes are made to DRAM module(s), such as additionally install or remove and reinstall (into the same/ different slot), it will result in approximately a 30 to 60 seconds delay when booting up for the first time after such change(s).*



## 2.4.2 Mini-PCle Socket & Pin Definition



When the mini-PCle module is installed, it is recommended that the ambient operating temperature stays under 60°C.

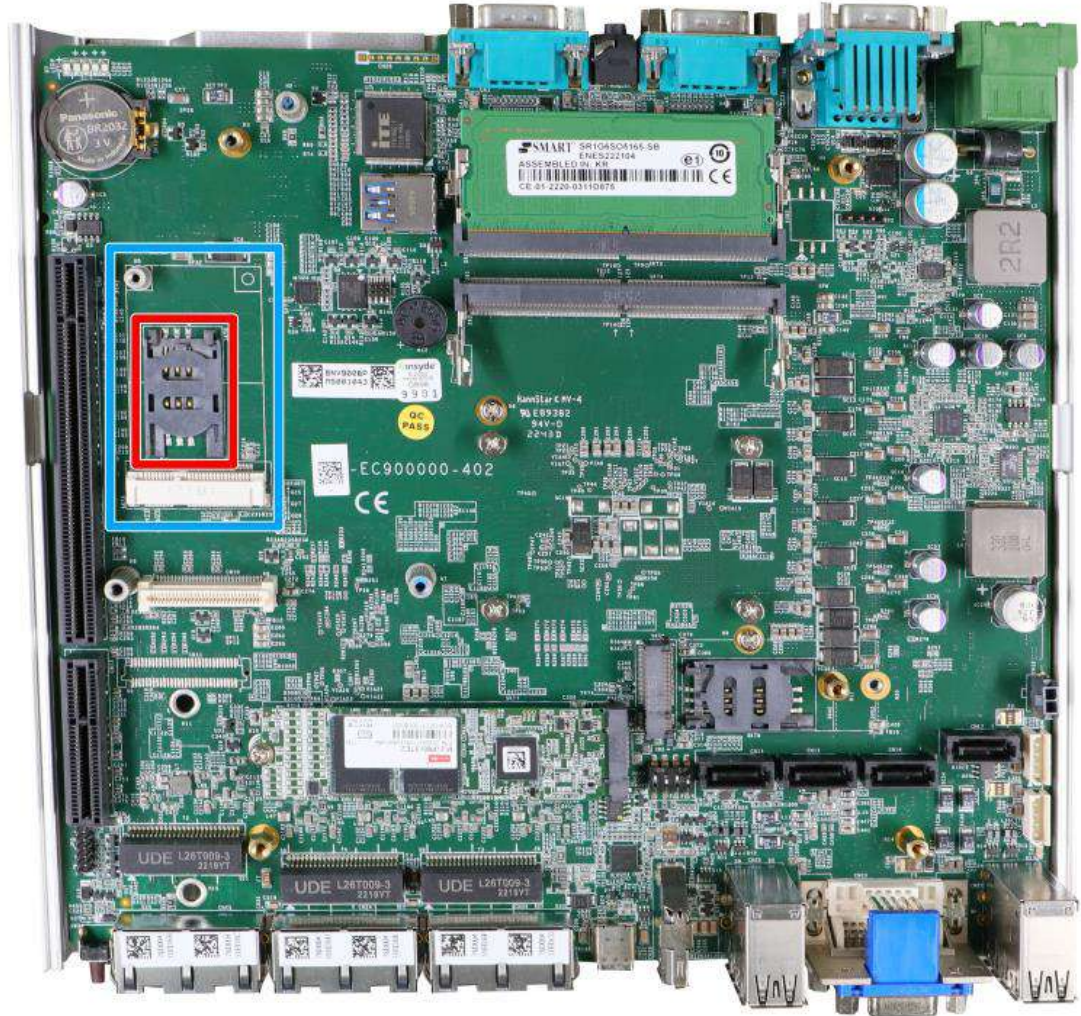

The system provides a mini-PCle socket (indicated in blue) that is in compliance with mini-PCle specification rev. 1.2. This mini-PCle socket is designed with SIM card (slot indicated in red) support. With a SIM card installed, your system can access the internet via your network provider's 4G/ 3G network.

For wireless (WiFi/ 5G/ 4G) communication, multiple SMA antenna apertures can be located on the system panel.

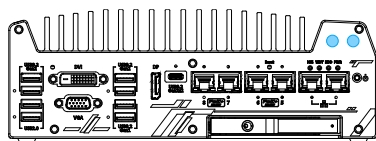

Front panel antenna opening

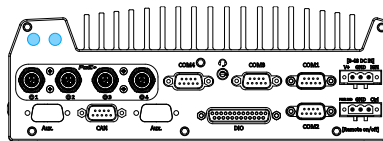

Rear panel antenna opening

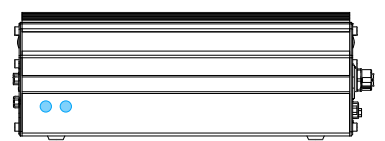

Side panel antenna opening



**mini-PCle socket definition**

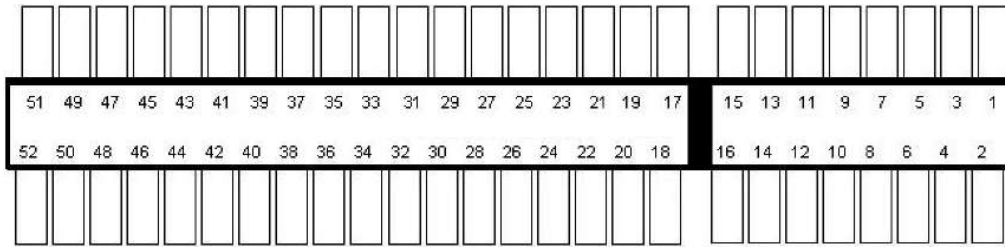

Pin	Signal (mPCle)	Pin #	Signal (mPCle)
1	WAKE#	2	+3.3Vaux
3	-	4	GND
5	-	6	+1.5V
7	CLKREQ#	8	UIM_PWR
9	GND	10	UIM_DATA
11	REFCLK-	12	UIM_CLK
13	REFCLK+	14	UIM_RESET
15	GND	16	UIM_VPP
<b>Mechanical Key</b>			
17	Reserved* (UIM_C8)	18	GND
19	Reserved* (UIM_C4)	20	W_DISABLE#
21	GND	22	PERST#
23	PERn0	24	3.3V
25	PERp0	26	GND
27	GND	28	+1.5V
29	GND	30	SMB_CLK
31	PETn0	32	SMB_DATA
33	PETp0	34	GND
35	GND	36	USB_D-
37	GND	38	USB_D+
39	3.3V	40	GND
41	3.3V	42	-
43	GND	44	-
45	Reserved	46	-
47	Reserved	48	+1.5V
49	Reserved	50	GND
51	Reserved	52	3.3V

 **WARNING**

*Some off-the-shelf mini-PCle 5G/4G modules are not compliant to standard mini-PCle interface. They use 1.8V I/O signals instead of standard 3.3V I/O and may cause signal conflict. Please consult with Neousys for compatibility when in doubt! Installing an incompatible 5G/ 4G module may damage the system or the module itself may be damaged.*

### 2.4.3 M.2 2242/ 3042/ 3052 (B Key), Mini-SIM Card Slot & Pin Definition

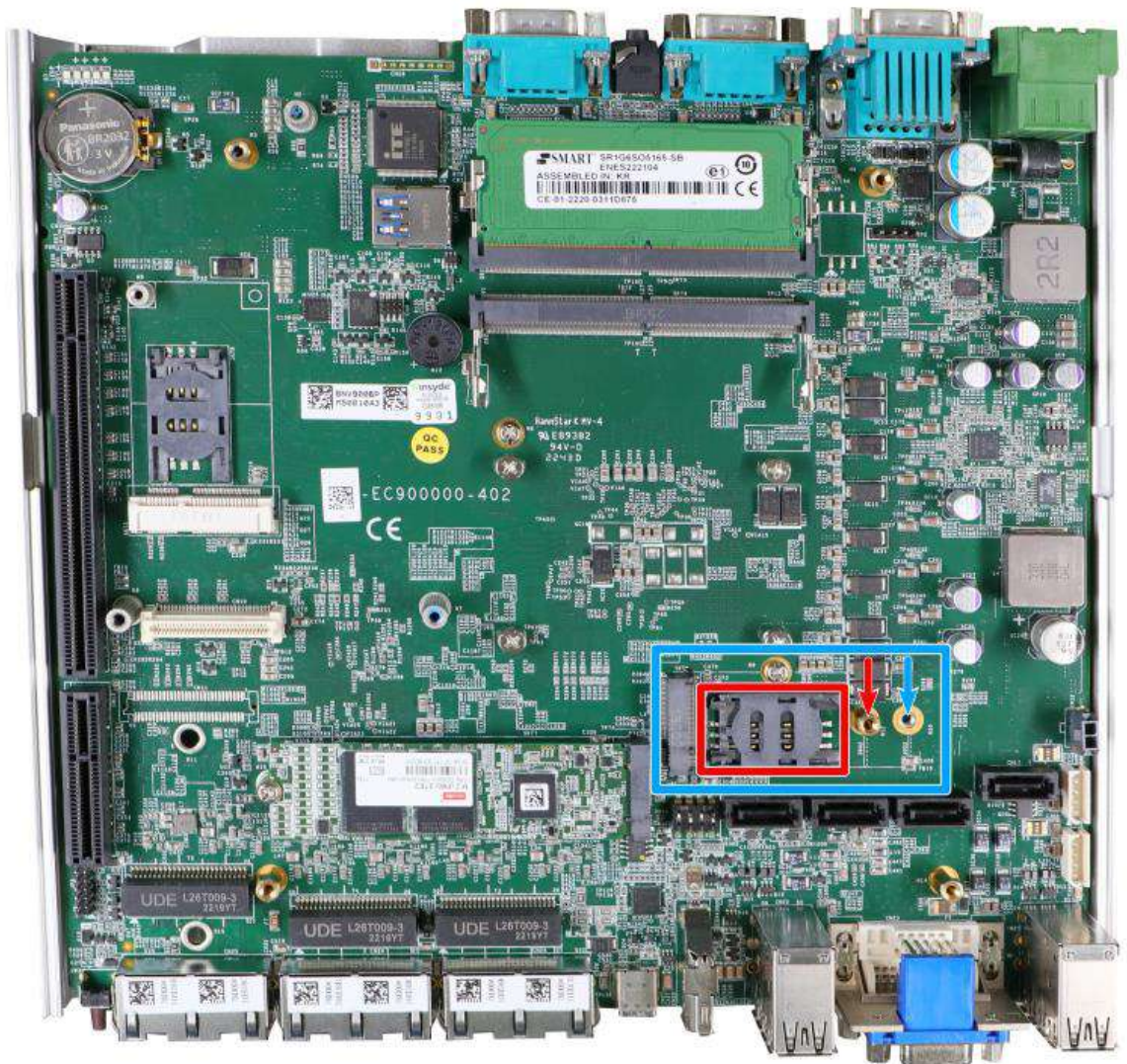

The system has an M.2 2242/ 3042/ 3052 slot (indicated in **blue rectangle**) with a 5G/ 4G SIM slot (indicated in **red rectangle**). A copper standoff is provided for you to secure onto the motherboard into the **red arrow** location for an M.2 2242/ 3042 module, or into the **blue arrow** location for an M.2 3052 module. By installing a 5G or 4G M.2 module and SIM card, you can access the internet via the provider's network.

For wireless 5G/ 4G, SMA antenna apertures are located on the system panel.

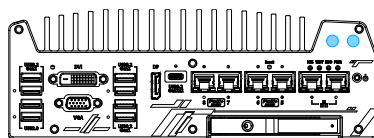

Front panel antenna opening

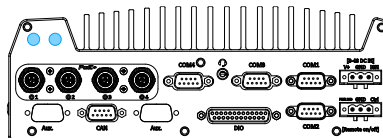

Rear panel antenna opening

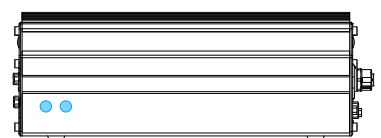

Side panel antenna opening

M.2 (B Key) Slot Pin Definition

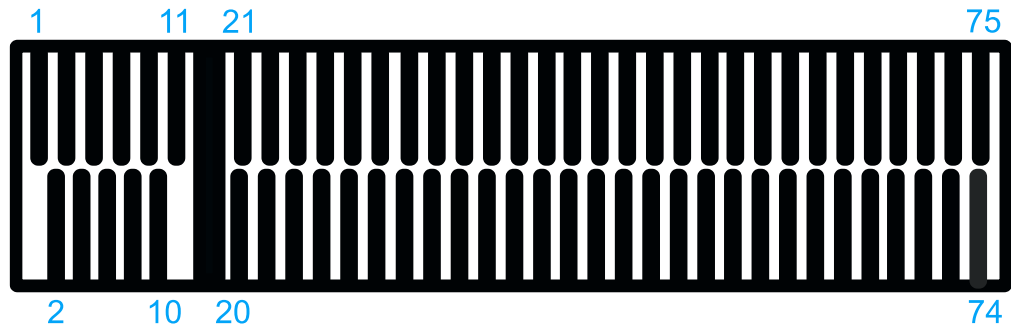

Pin #	Signal	Pin #	Signal
1	-	2	+3V3
3	GND	4	+3V3
5	GND	6	FULL_CARD_POWER_OFF_N
7	USB_D+	8	W_DISABLE_N
9	USB_D-	10	-
11	GND		
<b>Mechanical Key</b>			
21	-	20	-
23	-	22	-
25	-	24	-
27	GND	26	-
29	USB3.0-RX-	28	-
31	USB3.0-RX+	30	UIM1-RESET
33	GND	32	UIM1-CLK
35	USB3.0-TX-	34	UIM1-DATA
37	USB3.0-TX+	36	UIM1-PWR
39	GND	38	-
41	PERn0 / SATA-B+	40	UIM2-DET
43	PERp0 / SATA-B-	42	UIM2-DATA
45	GND	44	UIM2-CLK
47	PETn0 / SATA-A-	46	UIM2-RST
49	PETp0 / SATA-A+	48	UIM2-PWR
51	GND	50	PERST_N
53	REFCLKN	52	-
55	REFCLKP	54	-
57	GND	56	-
59	-	58	-
61	-	60	-
63	-	62	-
65	-	64	-
67	RESET_N	66	UIM1_DETECT
69	CONFIG_1	68	-
71	GND	70	+3V3
73	GND	72	+3V3
75	-	74	+3V3



## 2.4.4 SATA Ports

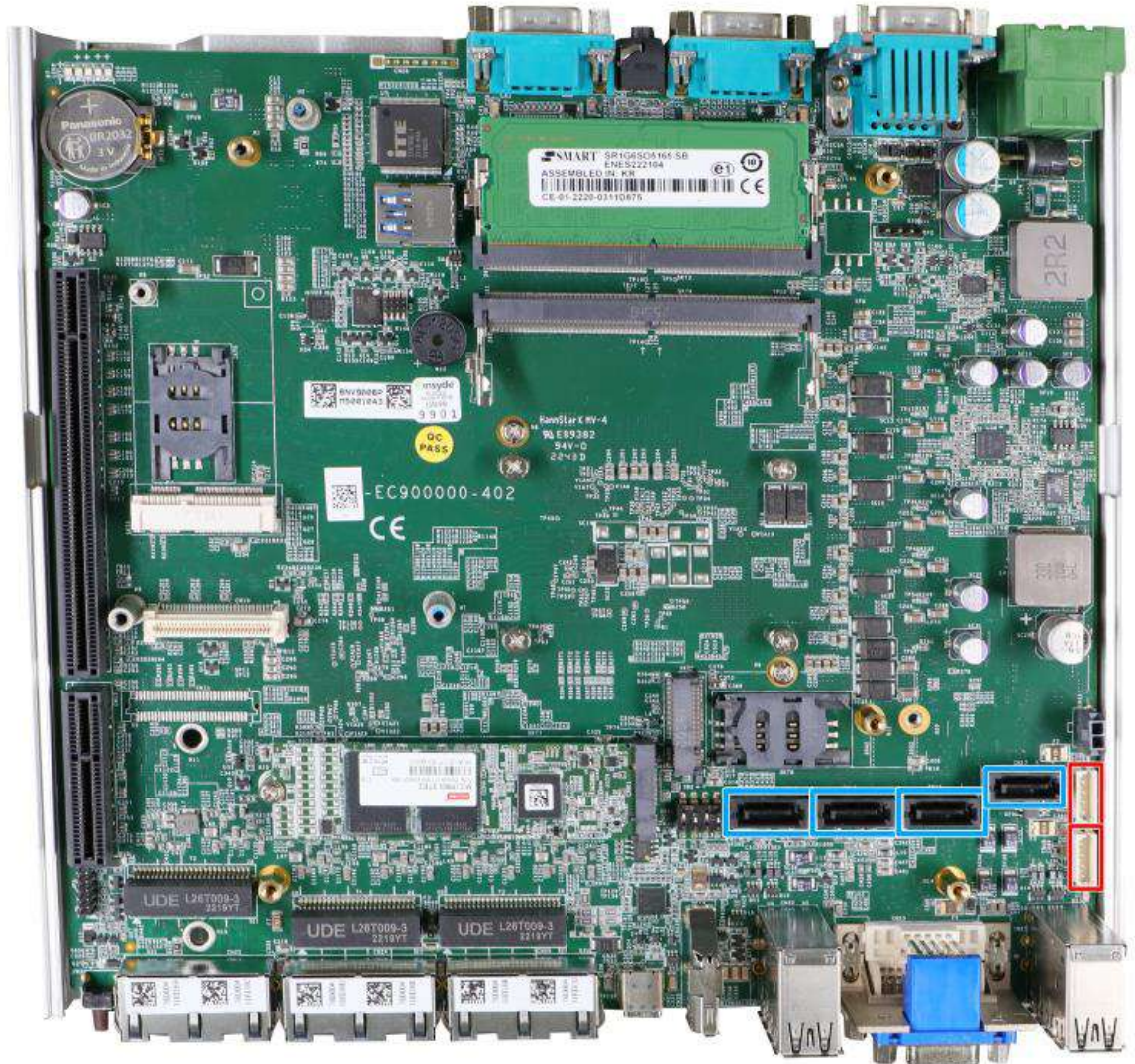

The system has four SATA ports which support Gen3, 6 Gb/s SATA signals. Each SATA port (indicated in **blue**) features a 7-pin SATA connector. However, due to mechanical restrictions, only two SATA ports can be accommodated inside the Nuvo-9000 series.

The two power connectors (indicated in **red**) can accommodate a 2.5" HDD/ SSD each in the internal HDD bracket. Standard 22-pin SATA connectors are provided with the system. You may refer to the SATA Configuration section for SATA settings.





### NOTE

*Supports up to 7mm thickness HDD/ SSD.*

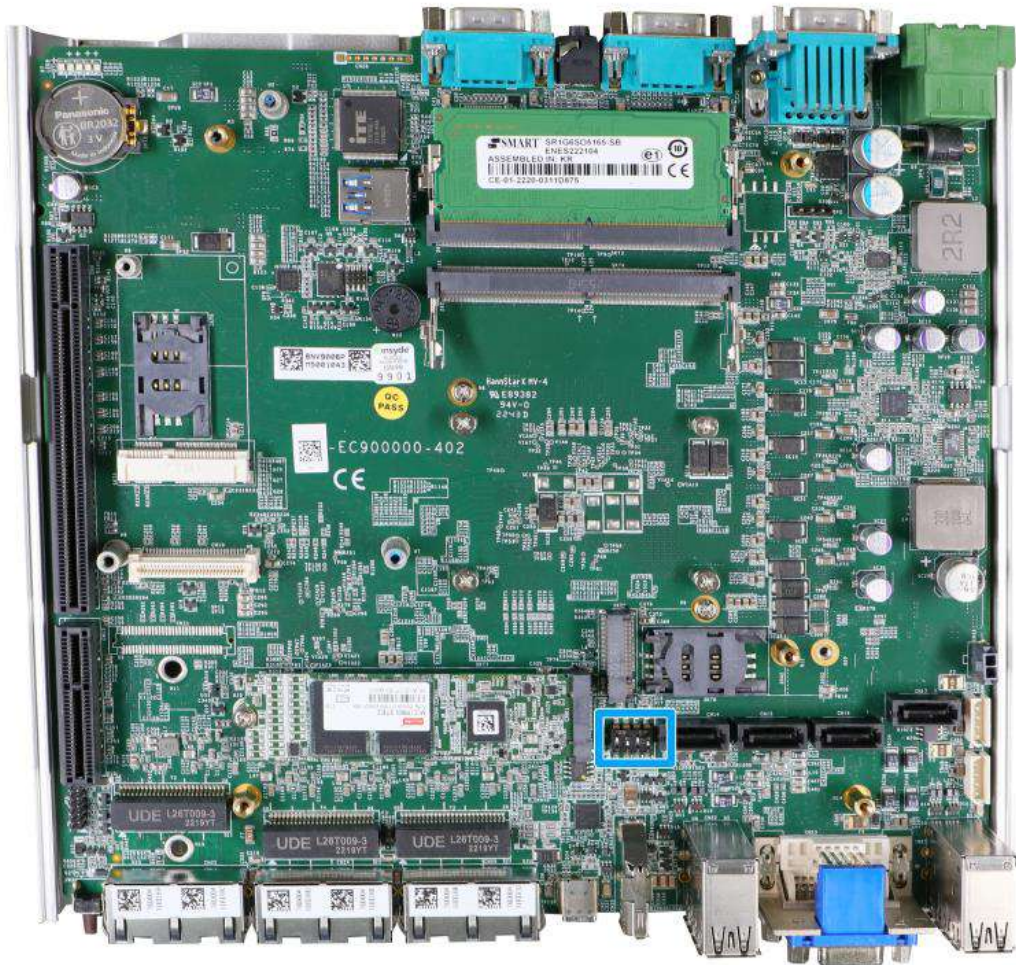
### 2.4.5 DIP Switch

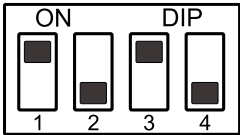

The DIP switch (indicated in blue) is reserved for manufacturing/ engineering purposes and should already be configured out of the factory. The table below shows the system default DIP switch settings for reference purposes.

System	DIP switch position
System default	
BIOS upgrade enabled	



**NOTE**

*Changing any DIP switches to the ON or OFF position will result in extra detection time during the start up process or cause system boot up issues.*



### 2.4.6 On/ Off Ctrl & Status Output

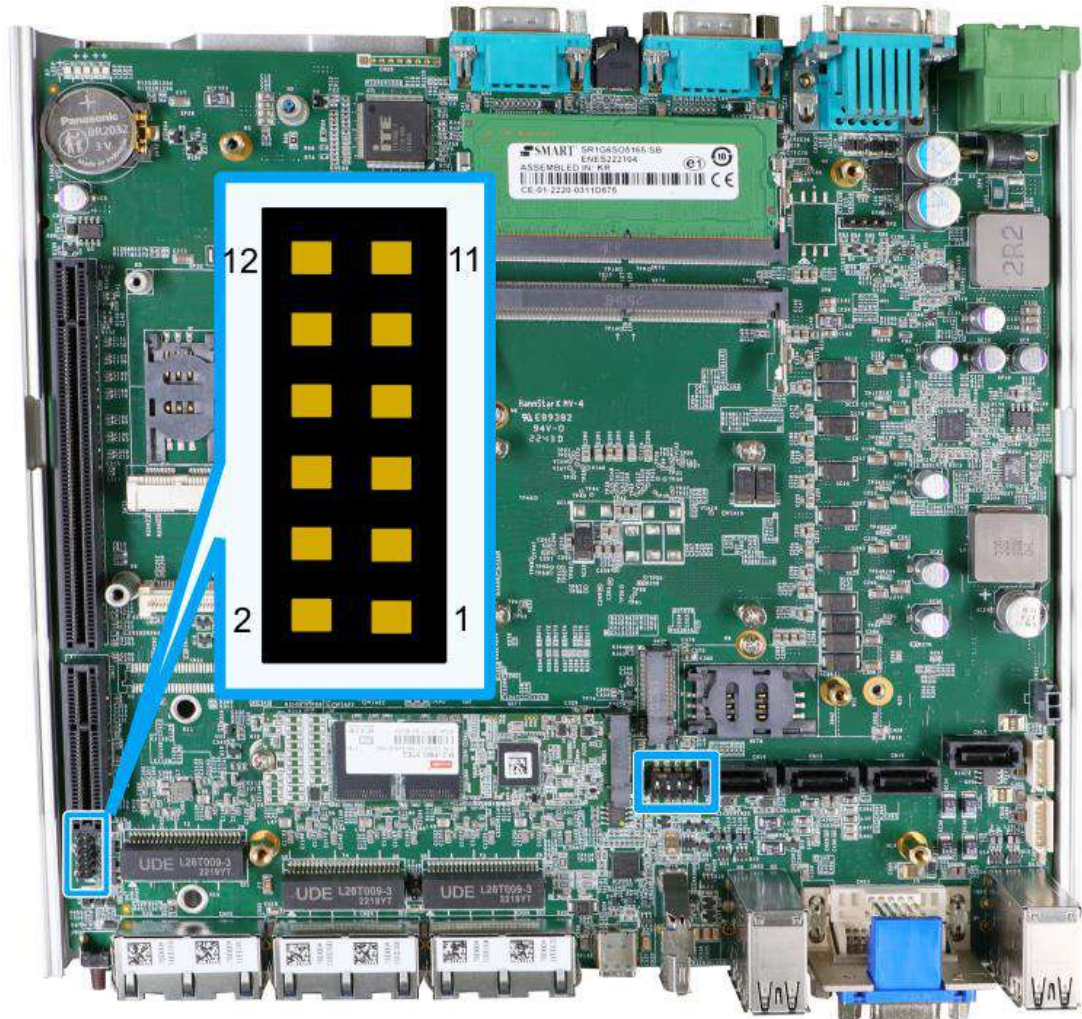

Pin#	Definition	Description
1	WDT_LED-	[Output] Watchdog timer indicator, flashing when Watchdog timer is active
2	WDT_LED+	
3	Standby Power-	[Output] Standby power indicator, on if DC power is applied and system is in S5 (standby) mode.
4	Standby Power+	
5	HDD-	[Output] Hard drive indicator, flashing when SATA hard drive is active.
6	HDD+	
7	Power-	[Output] System power indicator, on if system is turned on, off if system is turned off.
8	Power+	
9	Ctrl-	[Input] Remote on/off control, connects to an external switch to turn on/off the system (polarity is negligible).
10	Ctrl+	
11	IGN_LED-	[Output] Ignition control indicator, on if ignition control is on, off if ignition control is off.
12	IGN_LED+	

## 2.4.7 Internal USB 2.0 Port

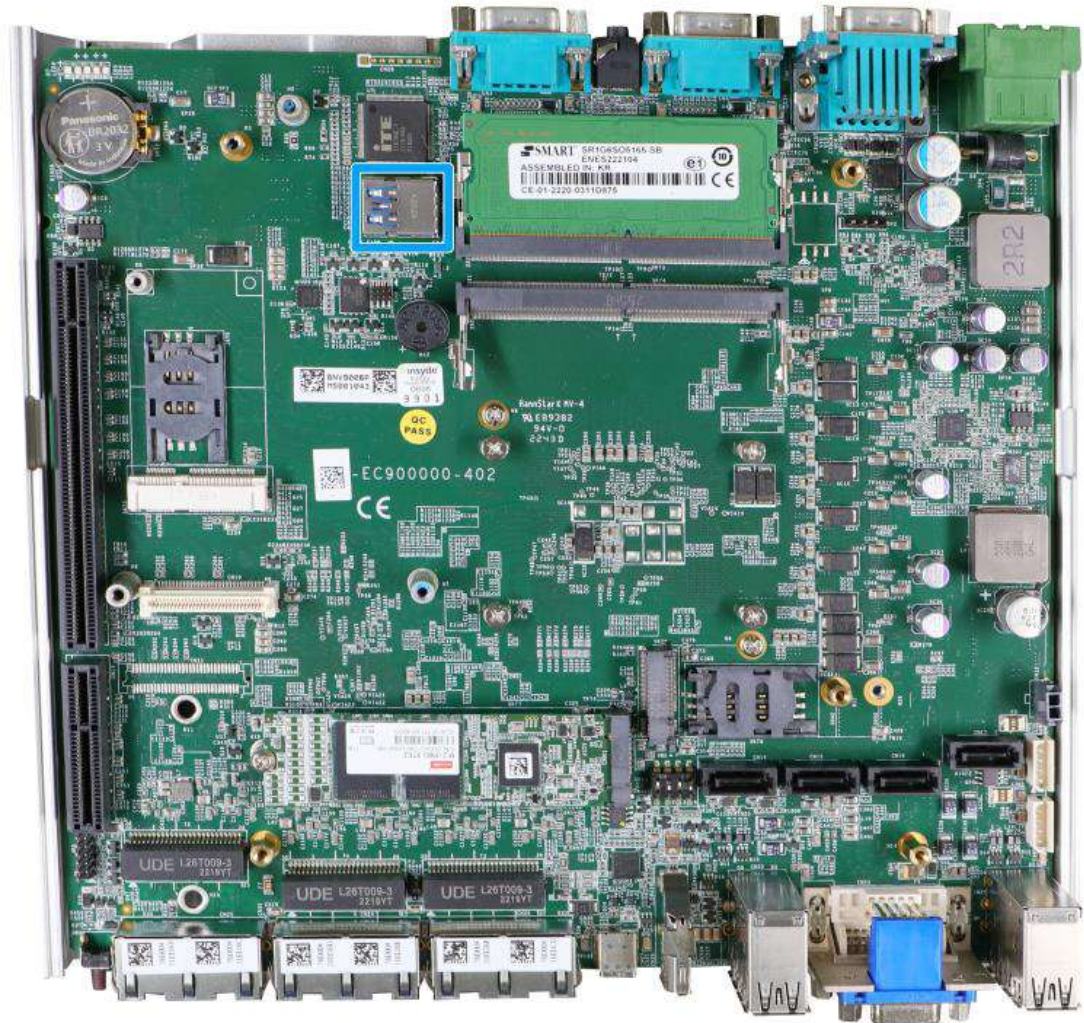

The system's motherboard has an internal USB2.0 port on the PCBA. You can utilize this USB port to connect a USB protection dongle inside the chassis of the system.



## 2.4.8 M.2 2280 (M Key) Slot for NVMe SSD

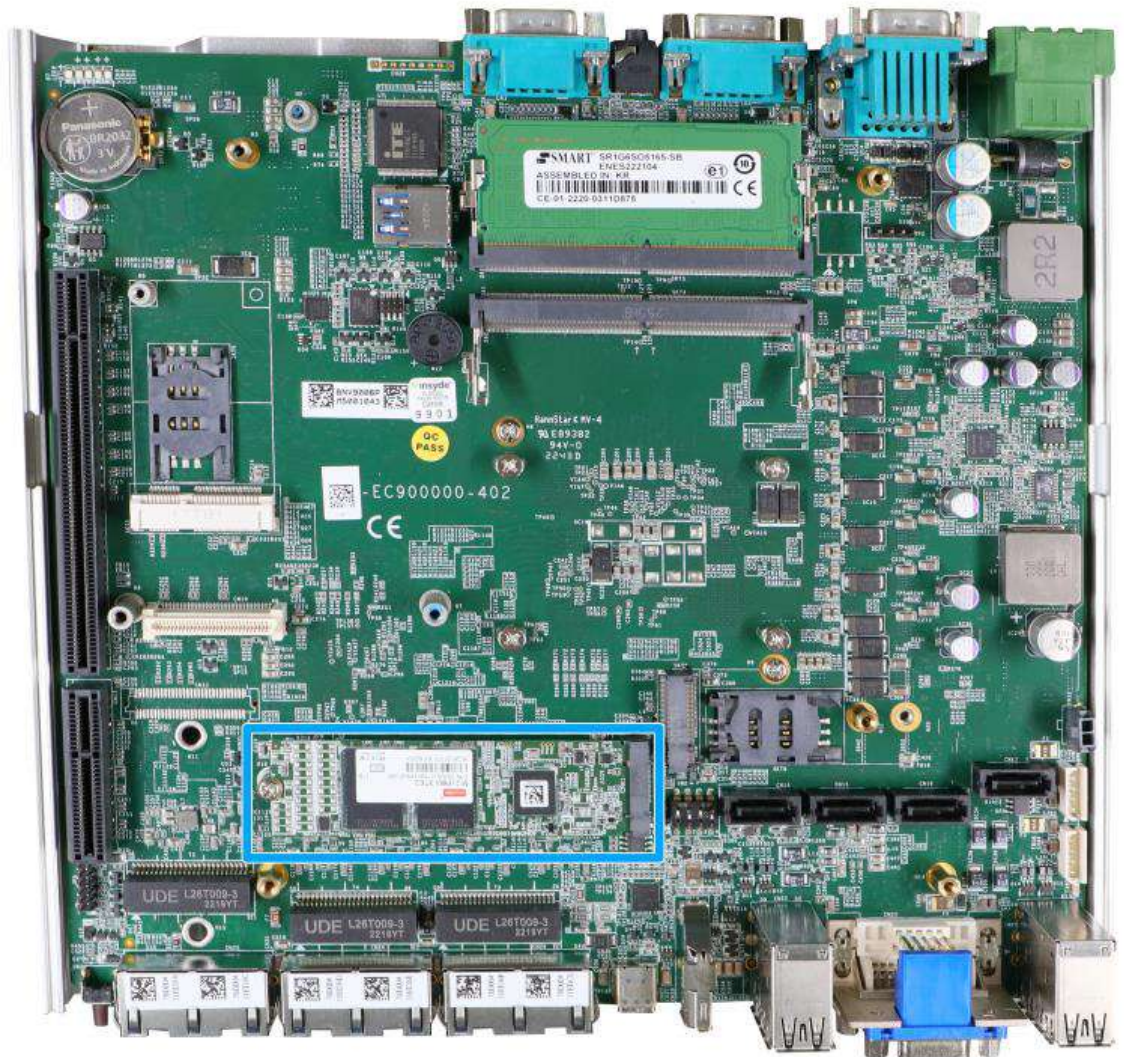

The system has a Gen4 x4 PCIe M.2 2280 slot for you to install an NVMe SSD. The M.2 NVMe SSD offers significantly better system performances when compared to a 2.5" SSD.



M.2 (M Key) Slot Pin Definition

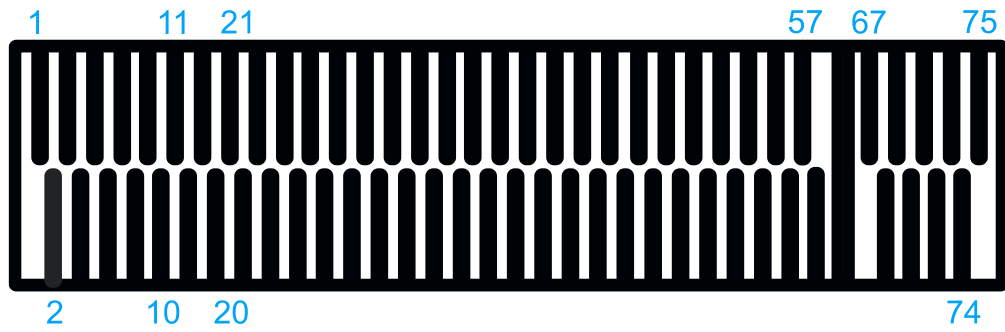

Pin #	Signal	Pin #	Signal
1	GND	2	+3V3
3	GND	4	+3V3
5	PERN3	6	-
7	PERP3	8	-
9	GND	10	DAS/DSS_N
11	PETN3	12	+3V3
13	PETP3	14	+3V3
15	GND	16	+3V3
17	PERN2	18	+3V3
19	PERP2	20	-
21	GND	22	-
23	PETN2	24	-
25	PETP2	26	-
27	GND	28	-
29	PERN1	30	-
31	PERP1	32	-
33	GND	34	-
35	PETN1	36	-
37	PETP1	38	-
39	GND	40	-
41	PERn0	42	-
43	PERp0	44	-
45	GND	46	-
47	PETn0	48	-
49	PETp0	50	PERST_N
51	GND	52	-
53	REFCLKN	54	-
55	REFCLKP	56	-
57	GND	58	-
<b>Mechanical Key</b>			
67	-	68	SUSCLK
69	PEDET	70	+3V3
71	GND	72	+3V3
73	GND	74	+3V3
75	GND		

### 2.4.9 M.2 Socket on MeziO™ Module

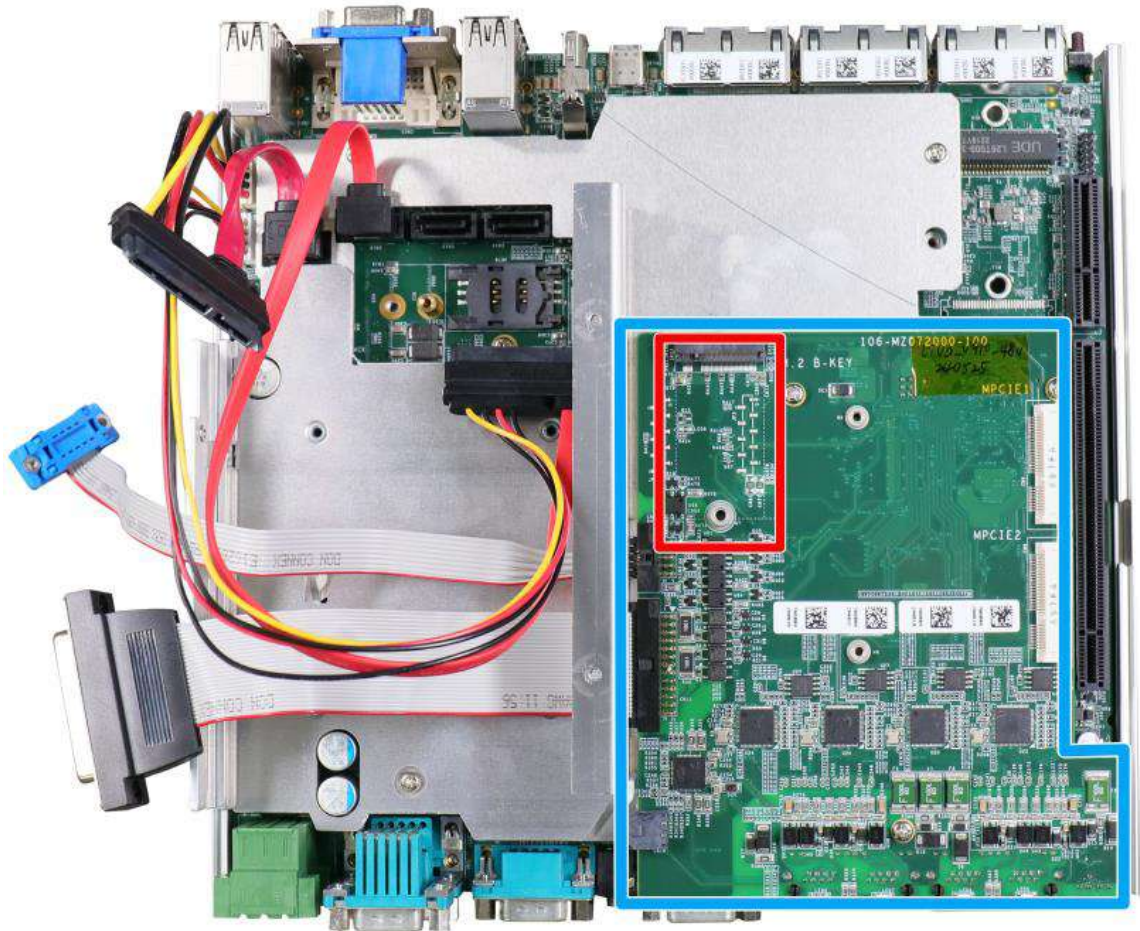

There is an additional M.2 2242 slot (indicated in red) available on the MeziO™ module (indicated in blue). To expand wireless networking capability, users can install off-the-shelf 4G/ 3G modules and access the internet via the provider’s network.

For wireless (4G/ 3G) communication, multiple SMA antenna apertures can be located on the system panel.

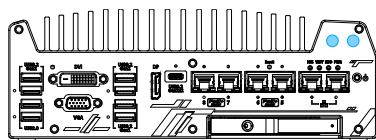

Front panel antenna opening

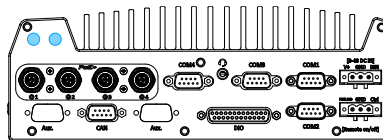

Rear panel antenna opening

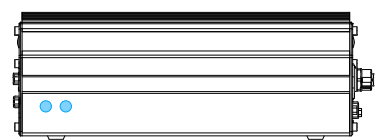

Side panel antenna opening

**M.2 (B Key) Slot Pin Definition**

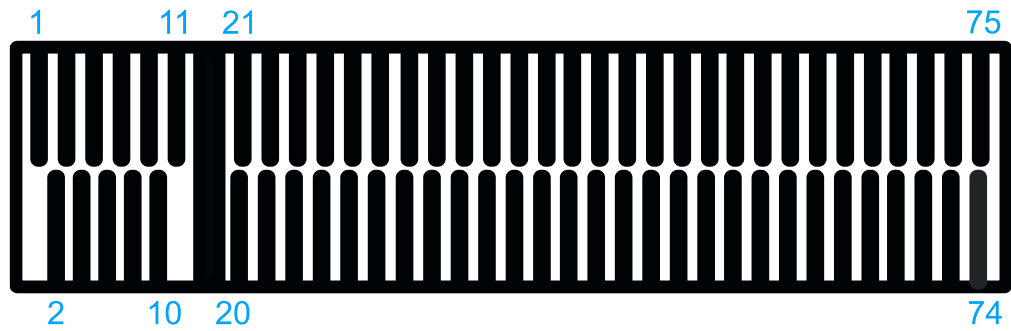

Pin #	Signal	Pin #	Signal
1	-	2	+3V3
3	GND	4	+3V3
5	GND	6	FULL_CARD_POWER_OFF_N
7	USB_D+	8	W_DISABLE_N
9	USB_D-	10	-
11	GND		
<b>Mechanical Key</b>			
21	-	20	-
23	-	22	-
25	-	24	-
27	GND	26	-
29	USB3.0-RX-	28	-
31	USB3.0-RX+	30	UIM1-RESET
33	GND	32	UIM1-CLK
35	USB3.0-TX-	34	UIM1-DATA
37	USB3.0-TX+	36	UIM1-PWR
39	GND	38	-
41	PERn0 / SATA-B+	40	UIM2-DET
43	PERp0 / SATA-B-	42	UIM2-DATA
45	GND	44	UIM2-CLK
47	PETn0 / SATA-A-	46	UIM2-RST
49	PETp0 / SATA-A+	48	UIM2-PWR
51	GND	50	PERST_N
53	REFCLKN	52	-
55	REFCLKP	54	-
57	GND	56	-
59	-	58	-
61	-	60	-
63	-	62	-
65	-	64	-
67	RESET_N	66	UIM1_DETECT
69	CONFIG_1	68	-
71	GND	70	+3V3
73	GND	72	+3V3
75	-	74	+3V3

### 2.4.10 mini-PCIe Socket on MeziO™ Module

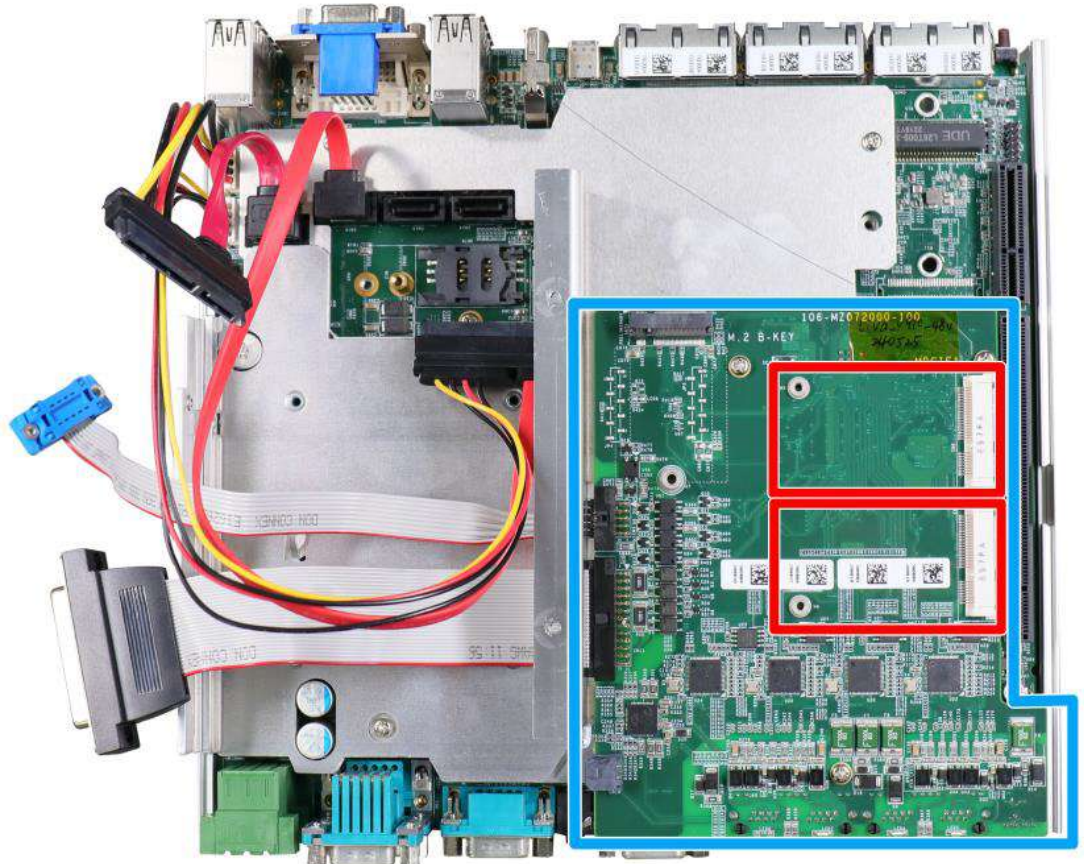

There are two additional full-size mini-PCIe sockets (indicated in **red**) available on the MeziO™ module (indicated in **blue**). They are implemented with USB signals only have better compatibility with off-the-shelf 3G/ 4G mini-PCIe modules. For customers who want to install 3G/ 4G module(s), please take advantage of these two mini-PCIe sockets and the associated SIM slots.

For wireless (3G/ 4G) communication, multiple SMA antenna apertures can be located on the system panel.

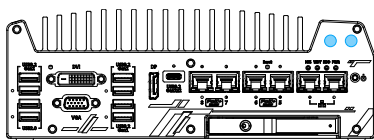

Front panel antenna opening

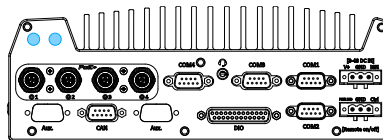

Rear panel antenna opening

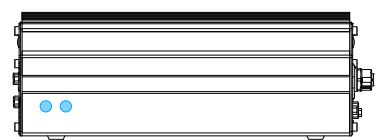

Side panel antenna opening

**mini-PCle Slot Pin Definition**

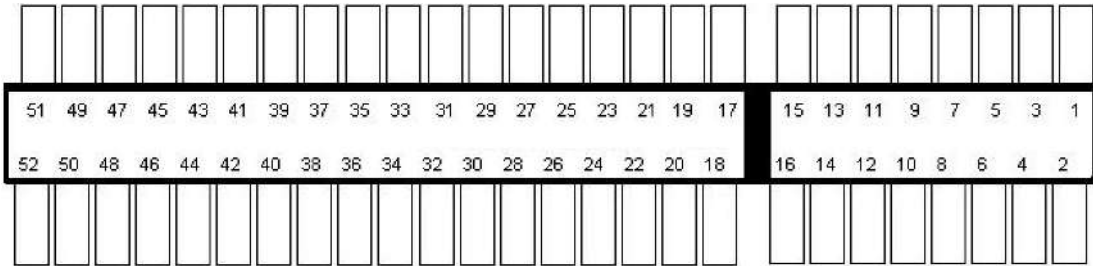

Pin #	Signal	Pin #	Signal
1	Reserved	2	+3.3Vaux
3	Reserved	4	GND
5	Reserved	6	+1.5V
7	Reserved	8	UIM_PWR
9	GND	10	UIM_DATA
11	Reserved	12	UIM_CLK
13	Reserved	14	UIM_RESET
15	GND	16	UIM_VPP
<b>Mechanical Key</b>			
17	Reserved	18	GND
19	Reserved	20	W_DISABLE#
21	GND	22	PERST#
23	Reserved	24	+3.3Vaux
25	Reserved	26	GND
27	GND	28	+1.5V
29	GND	30	Reserved
31	Reserved	32	Reserved
33	Reserved	34	GND
35	GND	36	USB_D-
37	GND	38	USB_D+
39	+3.3Vaux	40	GND
41	+3.3Vaux	42	LED_WWAN#
43	GND	44	LED_WLAN#
45	Reserved	46	LED_WPAN#
47	Reserved	48	+1.5V
49	Reserved	50	GND
51	Reserved	52	+3.3Vaux



### 2.4.11 Ignition Control Rotary Switch on MeziO™ Module

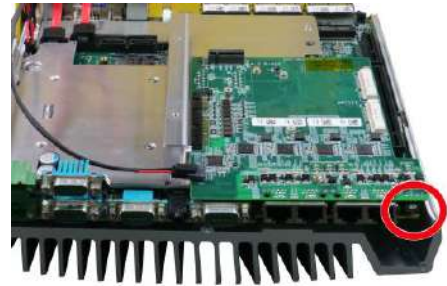

#### Nuvo-9100/ 9200VTC systems

For Nuvo-9100/ 9200VTC, the ignition control rotary switch can be found on the MeziO™ once you disassemble the enclosure.

For Nuvo-9x04/ 9x08VTC, the ignition control rotary switch can be found on the side, or can be accessed through the punch-out opening on the panel.

The ignition features multiple modes for pre and post ignition settings. Please refer to the section [Ignition Power Control](#) for details.

### 3 System Installation

Before disassembling the system enclosure and installing components and modules, please make sure you have done the following:

- It is recommended that only qualified service personnel should install and service this product to avoid injury or damage to the system.
- Please observe all ESD procedures at all times to avoid damaging the equipment.
- Before disassembling your system, please make sure the system has powered off, all cables and antenna (power, video, data, etc.) are disconnected.
- Place the system on a flat and sturdy surface (remove from mounts or out of server cabinets) before proceeding with the installation/ replacement procedure.

### 3.1 Disassembling the System

To access system internal components, the system needs to be disassembled. To disassemble the system enclosure, you need to remove the Cassette module and screws on both I/O panels.

1. Turn the system upside-down and remove the four screws at the bottom of the Cassette module.



**NOTE**

*Not applicable to Nuvo-9100VTC/ Nuvo-9104VTC/ Nuvo-9108VTC systems.*

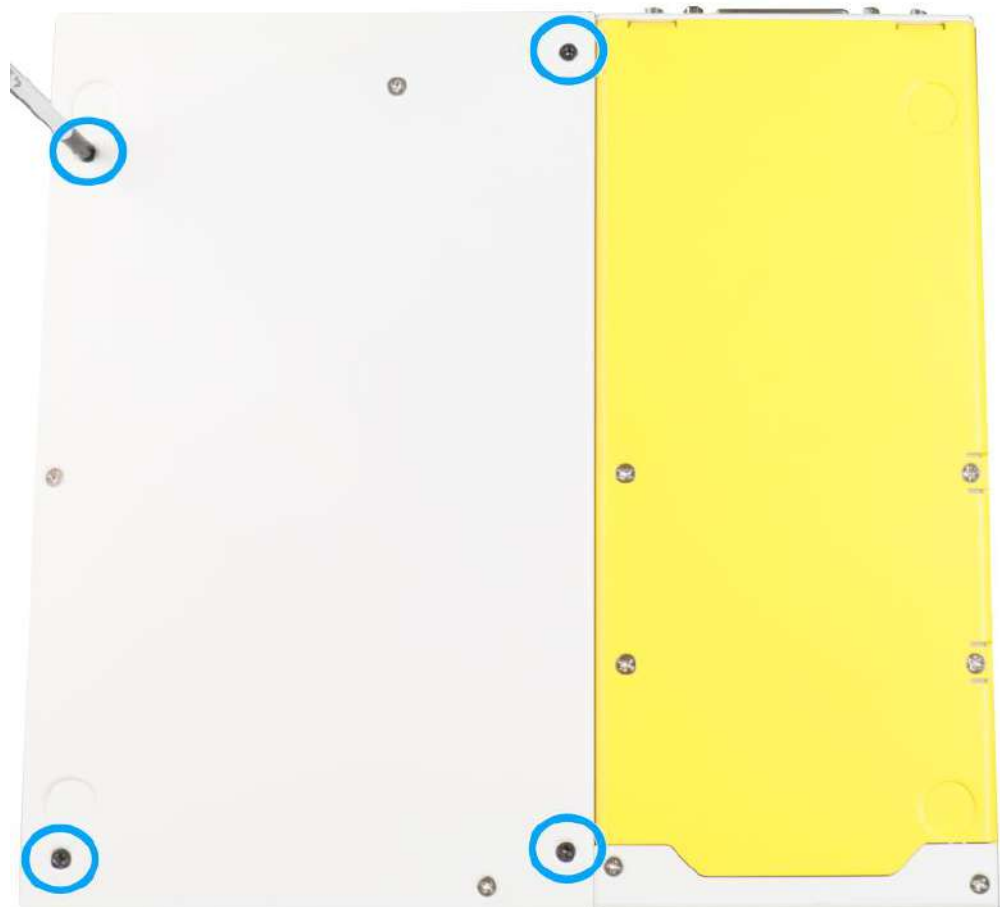



2. Gently wiggle and separate the Cassette module from the system.



*Not applicable to Nuvo-9100VTC/ Nuvo-9104VTC/ Nuvo-9108VTC systems.*



- On the front I/O panel, remove the screws indicated below, and remove the front panel.



**Nuvo-9200VTC series systems**



**Nuvo-9100VTC series systems**

- On the rear I/O panel, remove the screws indicated below, and remove the rear panel.



**Nuvo-9200VTC series systems**

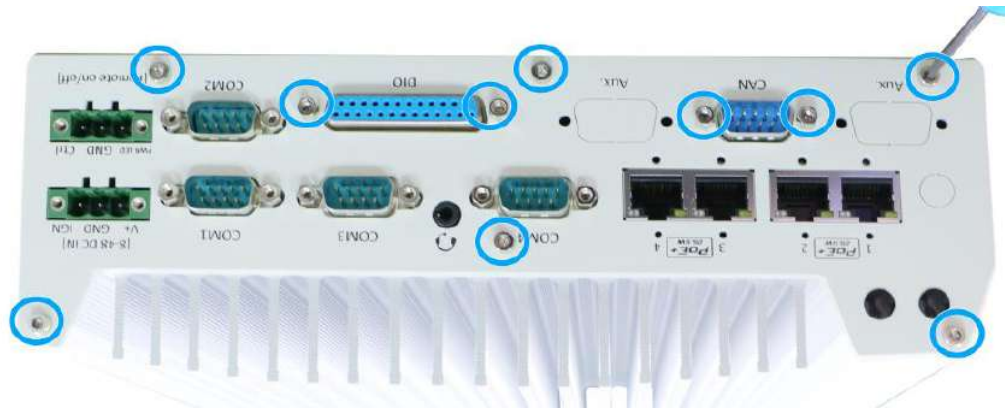

**Nuvo-9100VTC series systems**

- For Nuvo-9100VTC and Nuvo-9200VTC systems, an O-ring seal may pop out of the M12 connectors. Please safe-keep and reinsert them for enclosure installation



6. Remove the screws on the left side (facing the rear COM port panel).

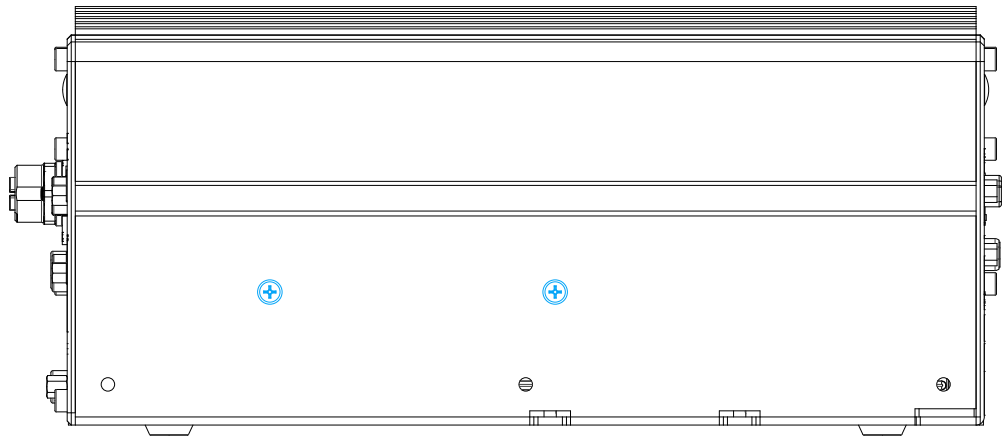

**Nuvo-9200VTC series systems**

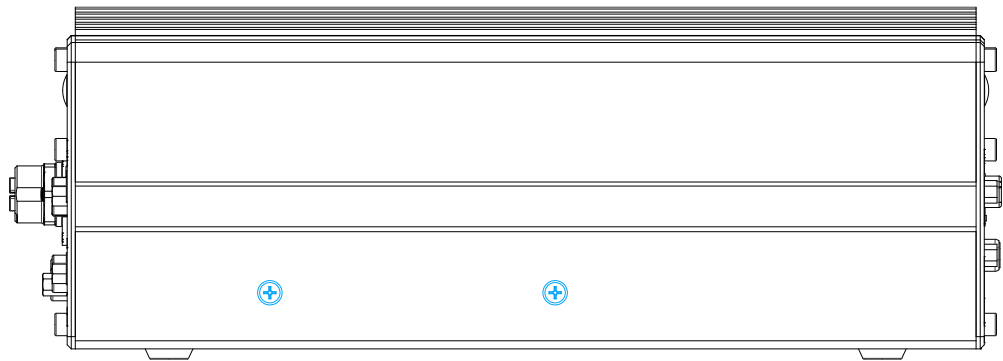

**Nuvo-9100VTC series systems**

7. Gently lift the system's bottom panel.

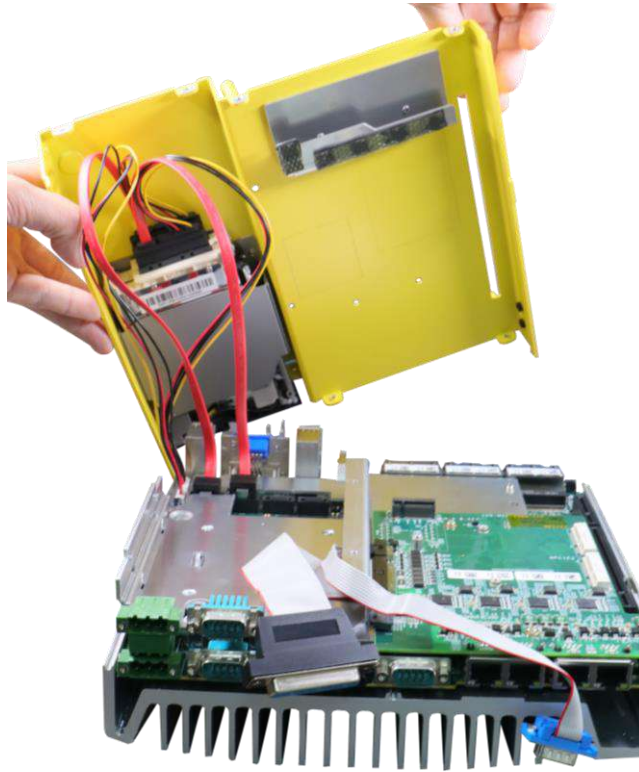

**Nuvo-9200VTC series systems**

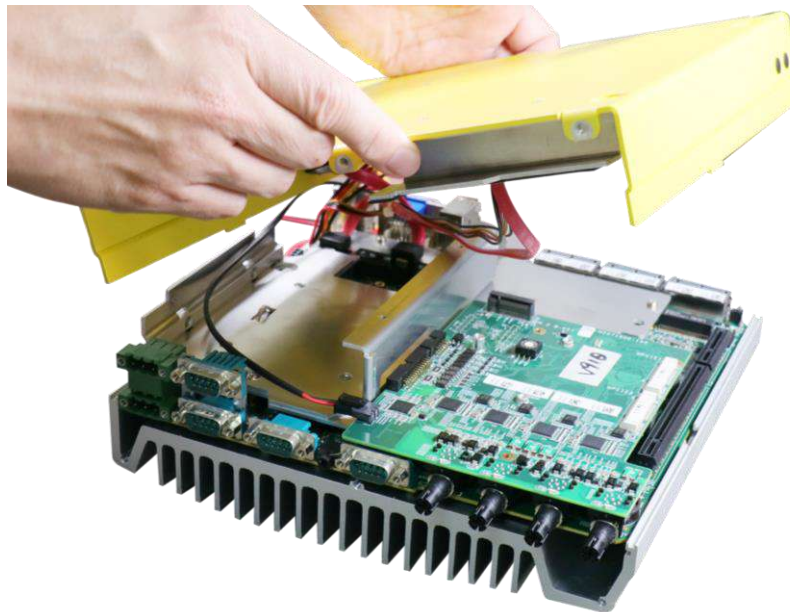

**Nuvo-9100VTC series systems**



**NOTE**

*Please disengage the 22-pin SATA cable connected to the 2.5" hot swappable tray before removing the bottom panel.*



8. Once the bottom panel has been removed, disengage the connectors shown.

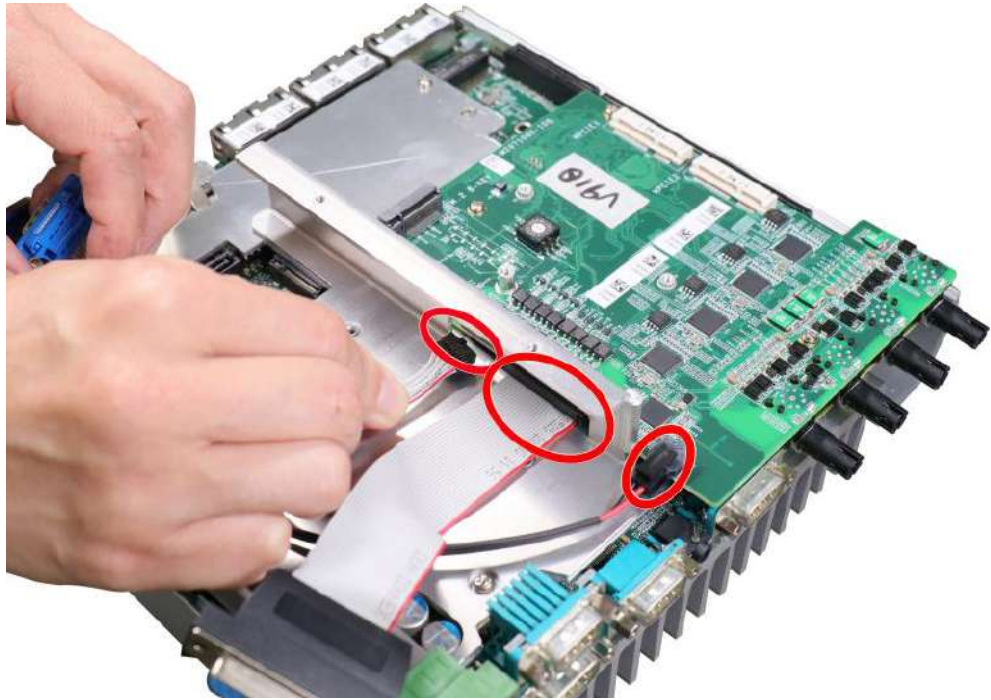

9. Remove the MeziO™ module by unscrewing the screws shown and gently lift to separate it from the motherboard.

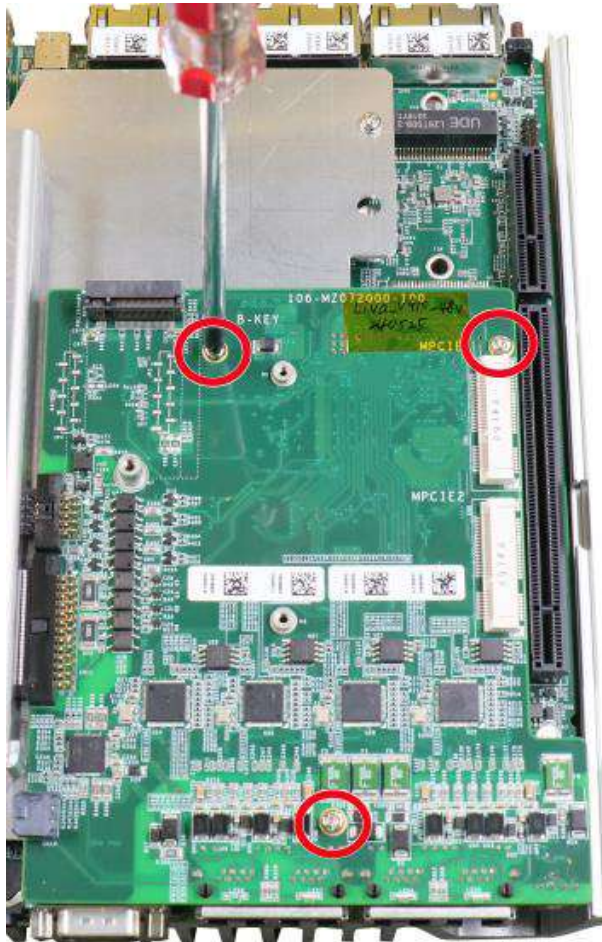

- Once the MezIO™ module has been separated, remove the heatsink/ support frame by removing the screws shown below.

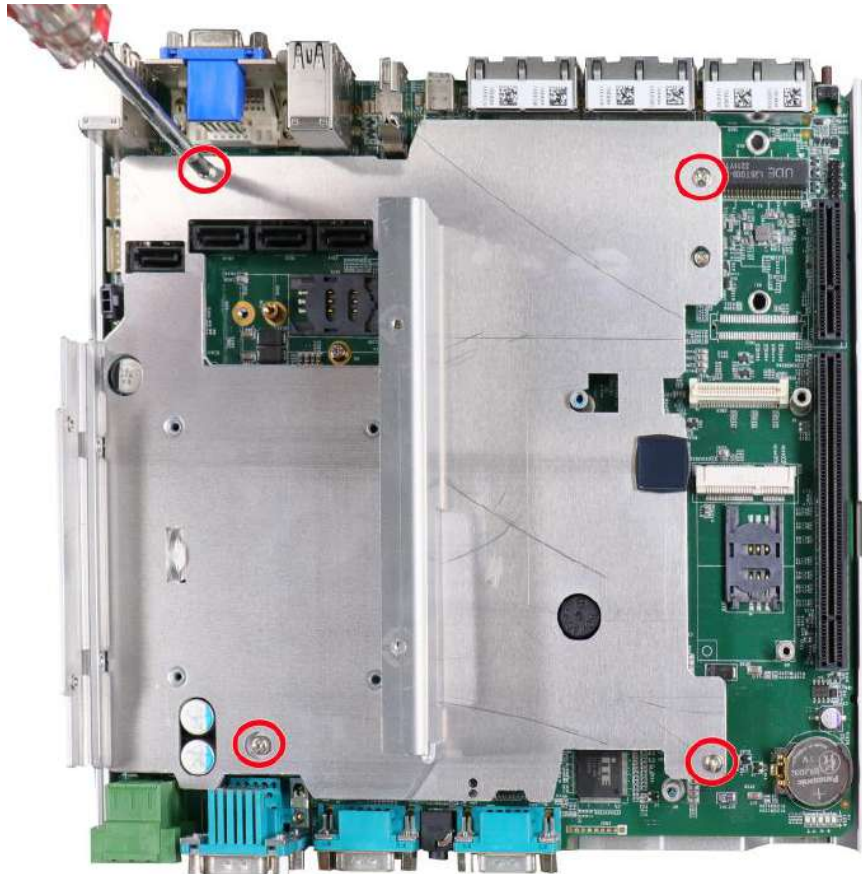

- You should now have access to expansion slots on the motherboard.

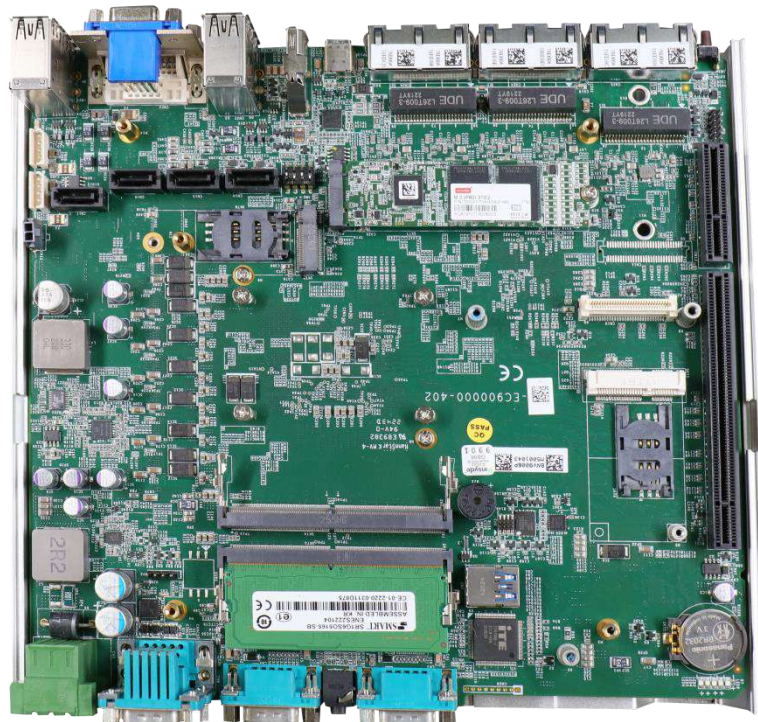



## 3.2 Installing Internal Components

### 3.2.1 CPU Installation for Barebone System

1. To install the CPU, you will need to separate the heatsink and the motherboard. Please refer to the [“Disassembling the System”](#) section.
2. To do so, remove the four screws indicated below.

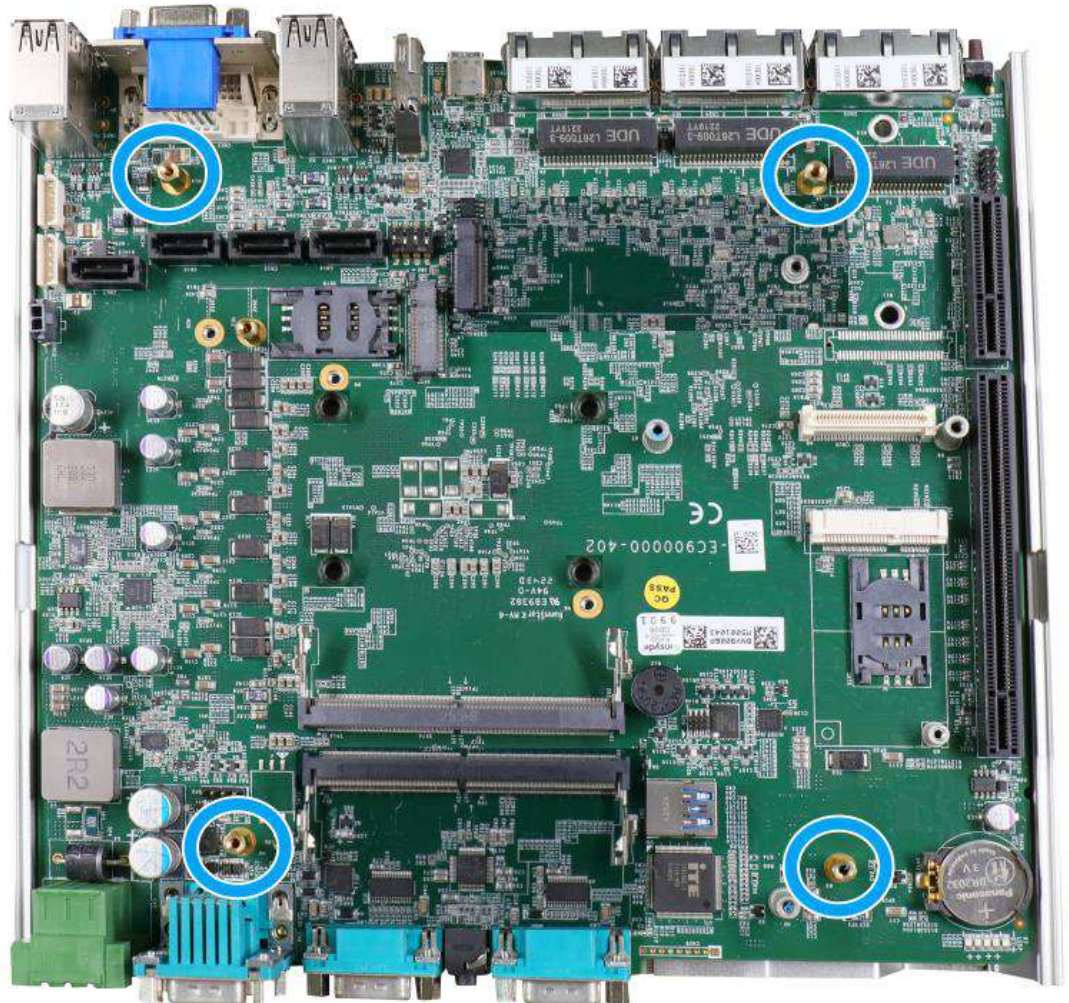

3. Gently separate the motherboard from the heatsink, you'll see the CPU socket protective cover, place finger tips underneath the sign "REMOVE" for leverage and gently lift the cover.

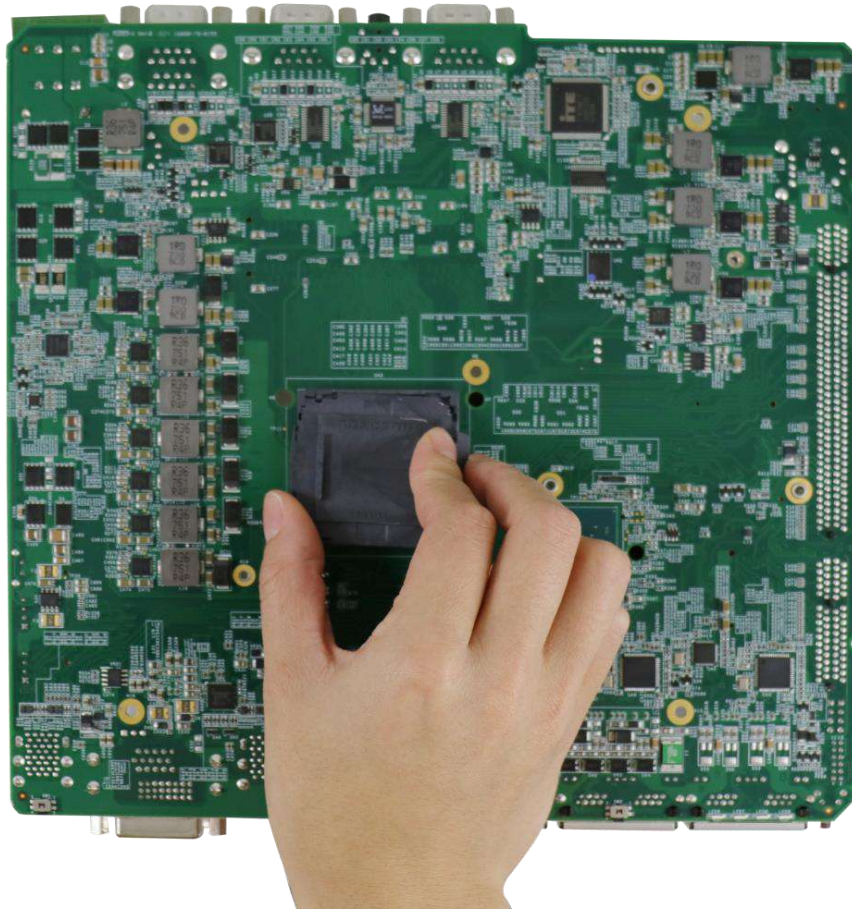

 **WARNING**

*With the protective cover removed, please be careful when handling the motherboard. DO NOT touch the pins in the LGA socket!*



- Remove the CPU from its container/ tray. Match the four notches on the side (indicated by the **blue arrows**) to the protrusions in the socket, gently lower the CPU into the socket. Pay attention to the seating orientation, notice there is a short side (indicated by **green lines**), and a long side (indicated by **red lines**).



- Locate the CPU retention bracket (holder) from the accessory box. Place the retention bracket on the CPU and hold it in place. Make sure the indicator triangle engraved on the CPU's integrated heat spreader (IHS) and the triangle indicator on the retention bracket are positioned in the same corner (indicated by **blue circles**).



6. Turn the motherboard around and secure the bracket by tightening two M3 P-head screws.

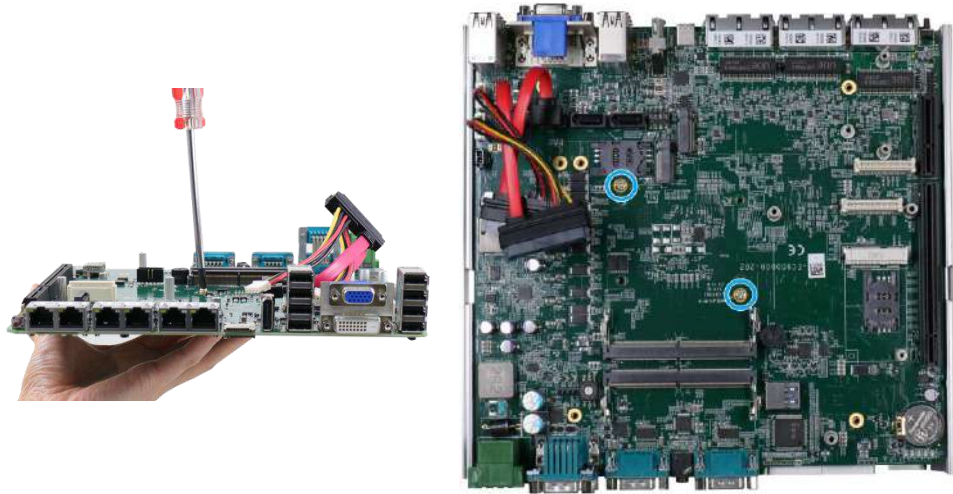

**Hold CPU bracket firmly and turn the motherboard around**

**Secure two M3 P-head screws**

7. Remove all thermal pads' protective films on the heatsink.

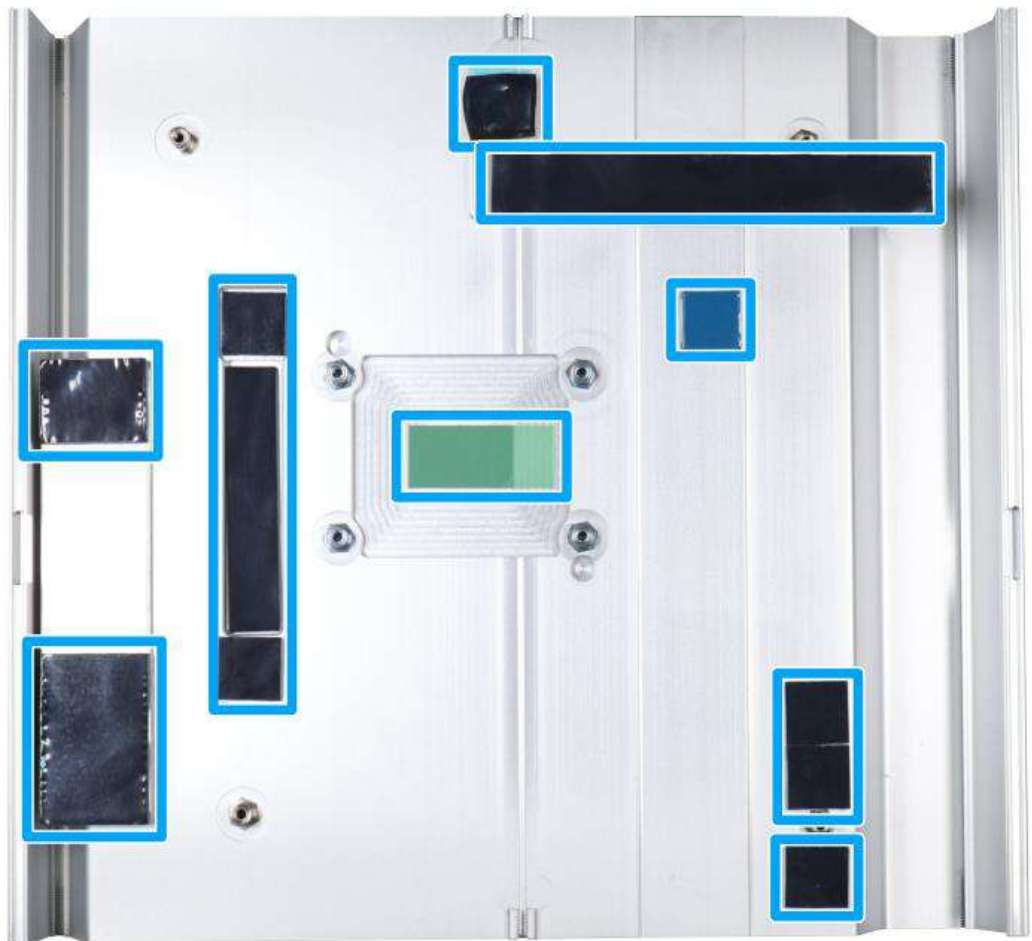

8. With the four motherboard standoffs aligned, gently lower the motherboard onto the heatsink and secure the four screws. Please remember to remove the protective film (indicated in red) on the CPU's thermal pad as well.

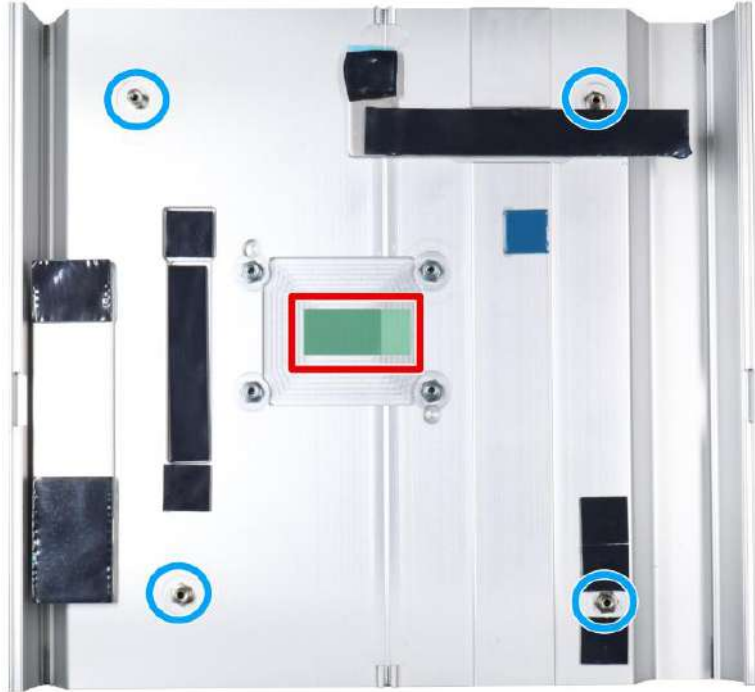

**Four standoffs on the heatsink**



**Secure motherboard with four screws**



- Once the motherboard has been installed, you're ready to secure the five screws that help the heatsink apply pressure to the CPU/ chipset die. You'll want to apply even pressure to the corners by gradually tightening each screw. Please refer to the recommended order when tightening the screws.

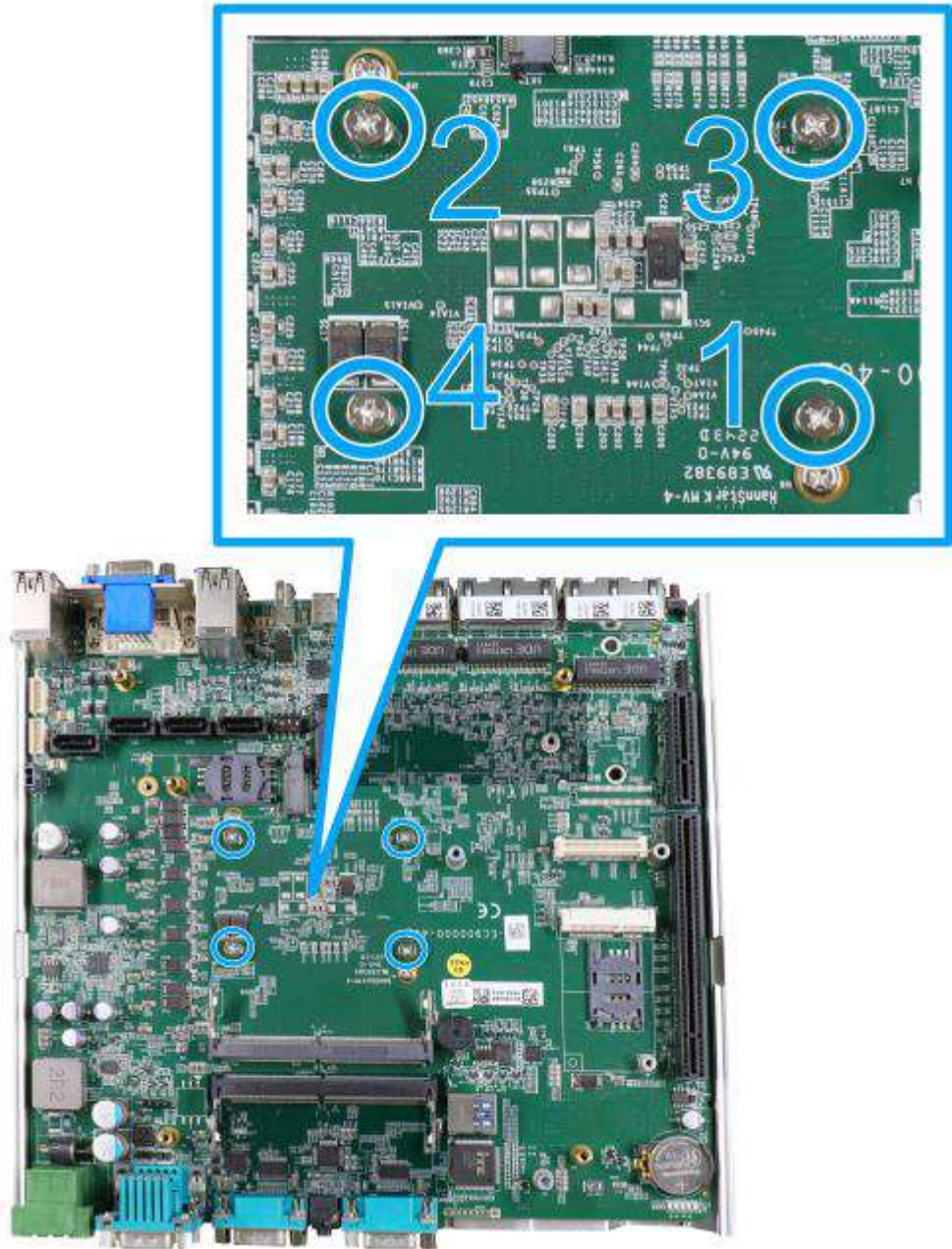

- [Reinstall the system enclosure](#) and Cassette module when done.
- If you need to install other components, please refer to respective sections.

### 3.2.2 Remove and Replace the Existing CPU

1. To replace the existing CPU, you will need to separate the heatsink and the motherboard.
2. To do so, remove the eight screws indicated below.

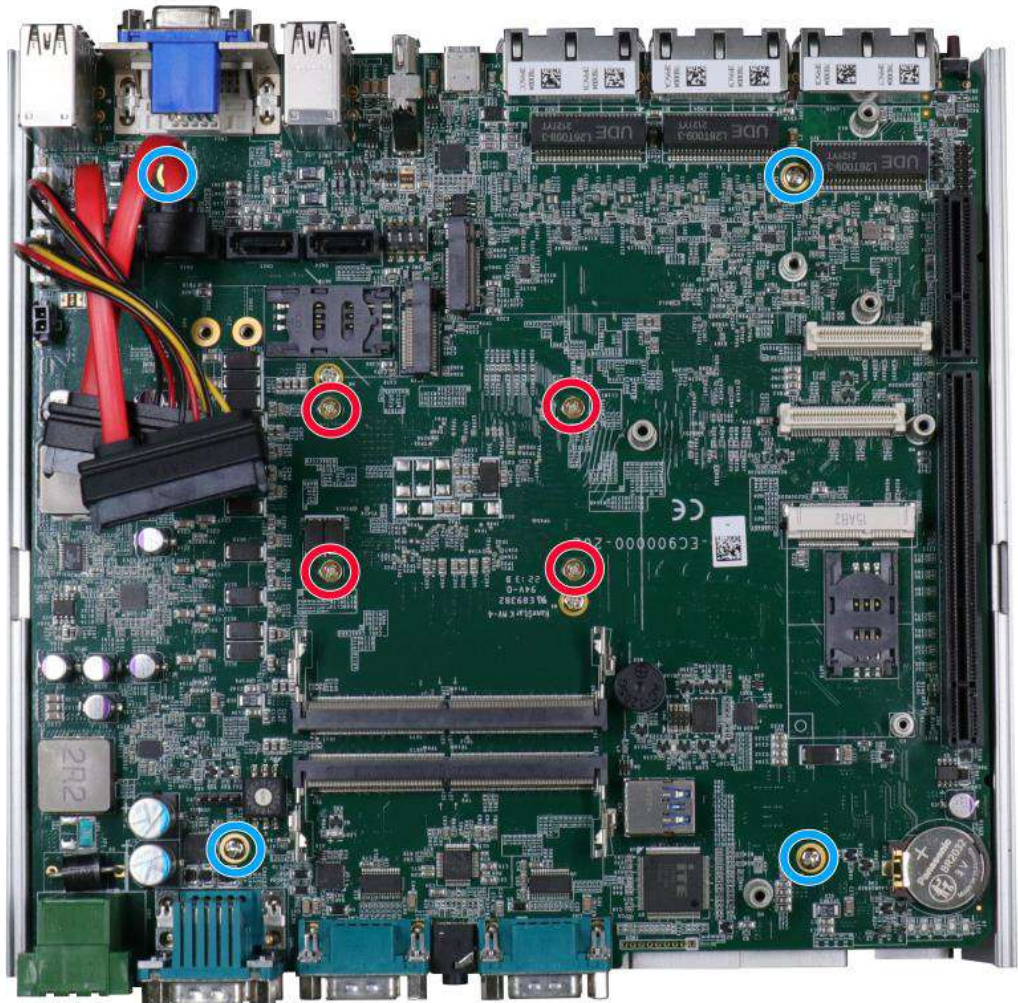



3. Remove the screws indicated once you separate the heatsink from the motherboard to remove the CPU holder.

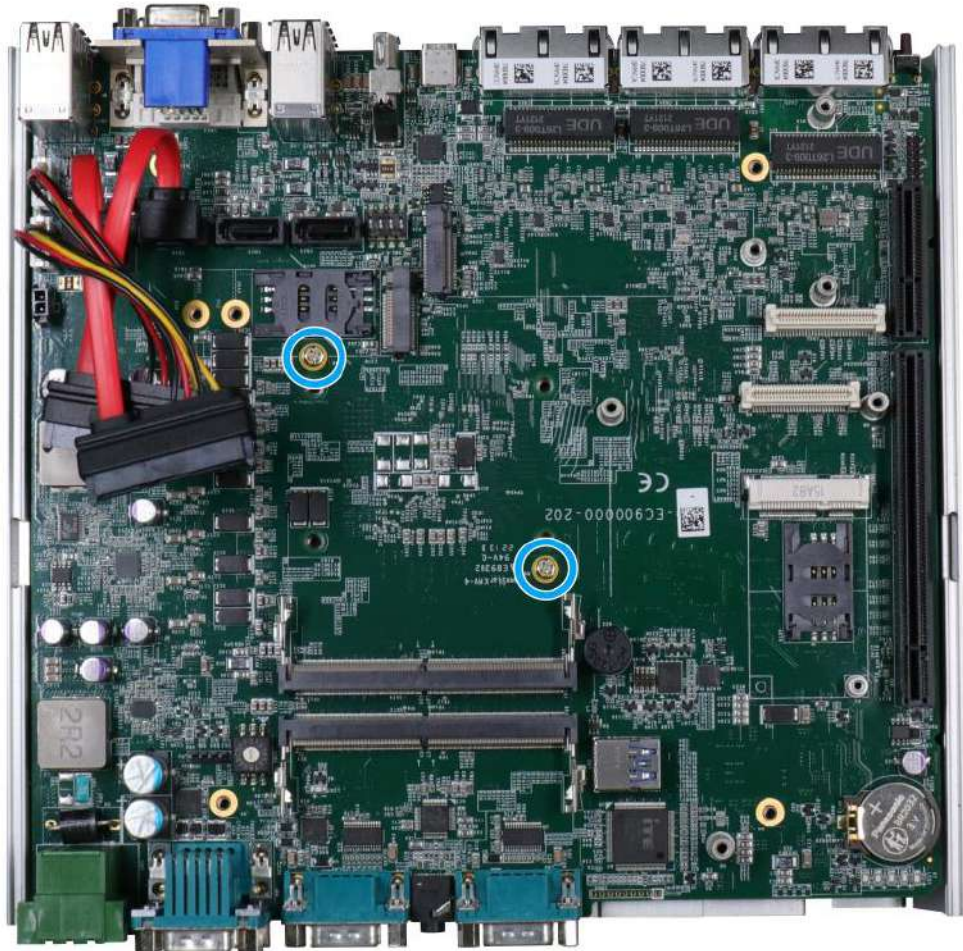

4. At this point, the CPU and retention bracket may be stuck onto the heatsink (due to the thermal pad). Please use a plastic pry tool and gently separate the CPU/ holder from the heatsink.

 **WARNING**

*With the heatsink, CPU, and retention bracket removed, please be careful when handling the motherboard. DO NOT touch the pins in the LGA socket!*

5. Gently separate the CPU from the retention bracket, and clean off any thermal pad residues on the heatsink and on the retention bracket.



**CPU retention bracket (holder)**

 **WARNING**

*With the CPU removed, please be careful when handling the motherboard. DO NOT touch the pins in the LGA socket!*

6. Place a new CPU thermal pad (indicated in blue) onto the heatsink for the new CPU.

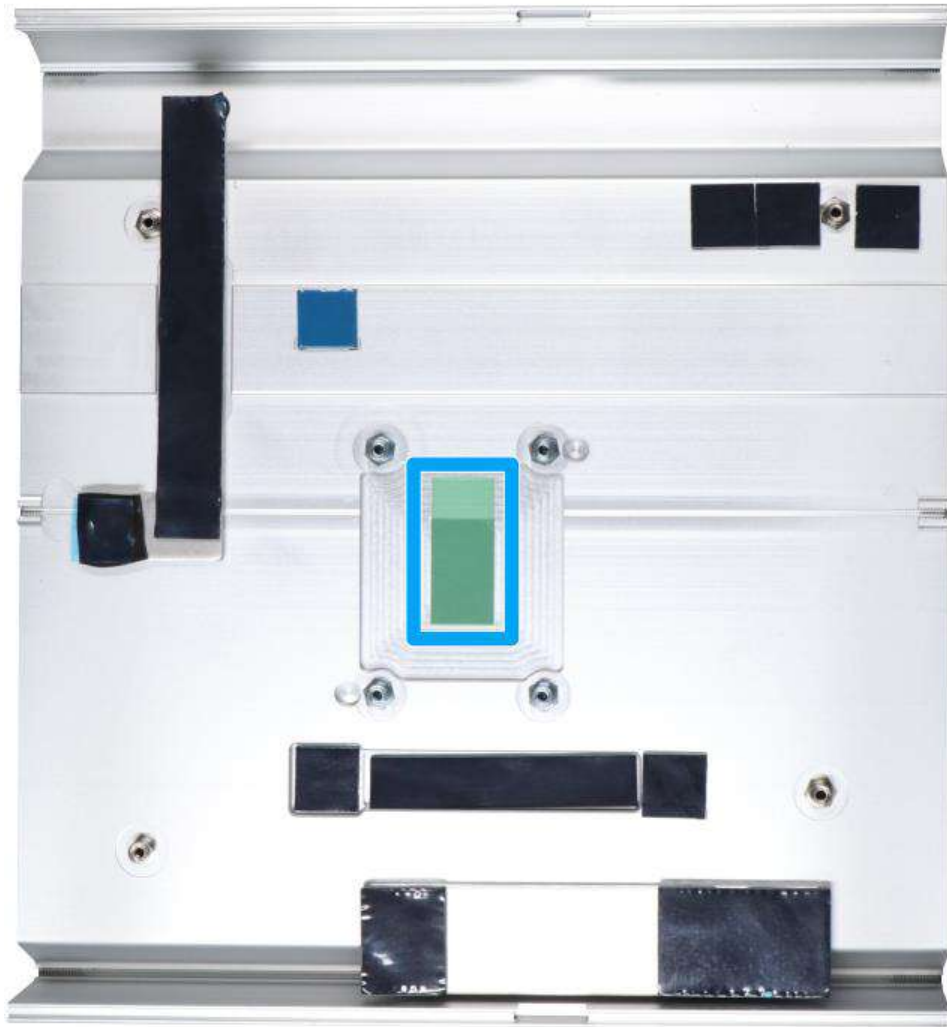

7. Remove and clean off any thermal pad residues around the socket/ motherboard. Gently place the new CPU into the socket by matching the four notches (indicated by **blues arrows**) on the side to the protrusions in the socket. Pay attention to the seating orientation, notice there is a short side (indicated by **green lines**), and a long side (indicated by **red lines**).



8. Make sure all thermal pad residues have been cleaned on both sides of the retention bracket. Place the CPU retention bracket (holder) on top of the CPU and hold it in place. Make sure the indicator triangle engraved on the CPU's integrated heat spreader (IHS) and the triangle indicator on the retention bracket are positioned in the same corner (indicated by **blue circles**).





9. Turn the motherboard around and secure the bracket by tightening two M3 P-head screws.

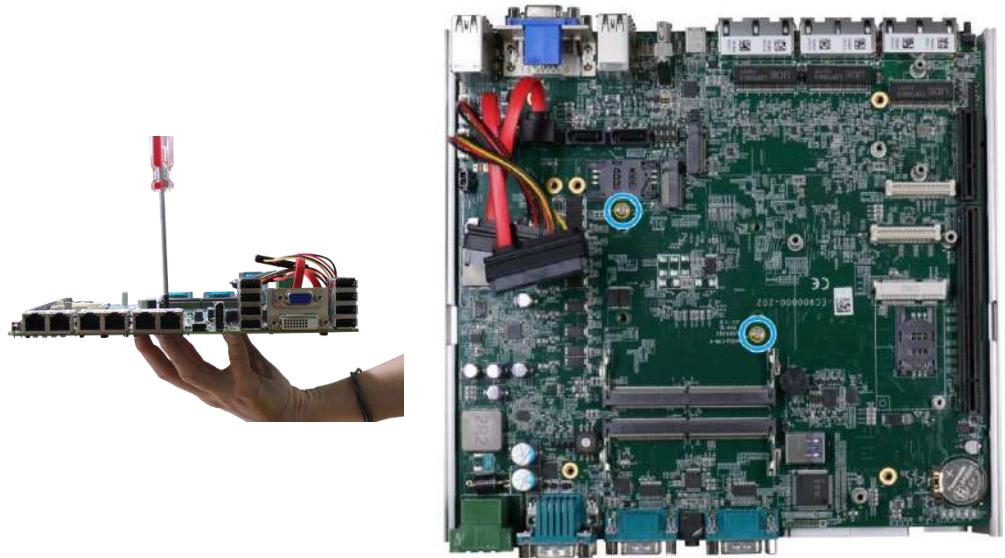

**Hold CPU bracket firmly and turn the motherboard around**

**Secure two M3 P-head screws**

10. Align the motherboard to the four standoffs on the heatsink, gently lower the motherboard onto the heatsink and secure with four screws.

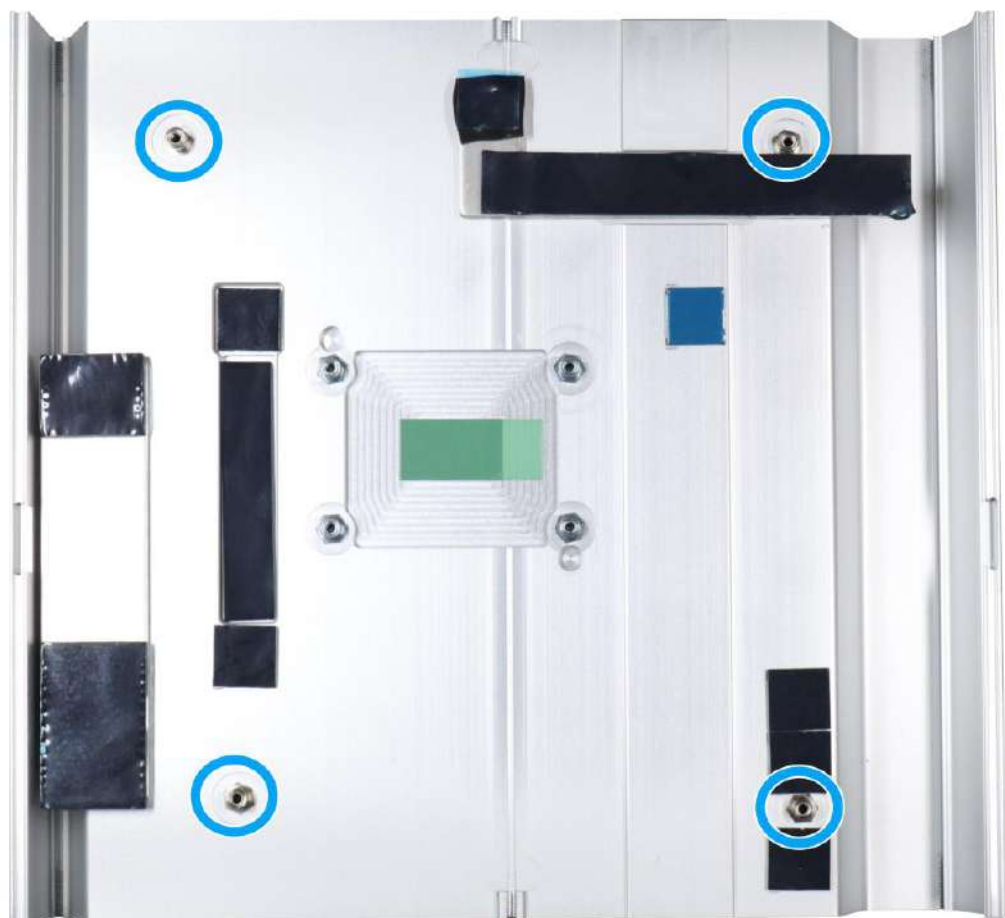

11. Once the motherboard has been installed, you're ready to secure the four screws that help the heatsink apply pressure to the CPU/ chipset die. You'll want to apply even pressure to the corners by gradually tightening each screw. Please refer to the recommended order when tightening the screws.

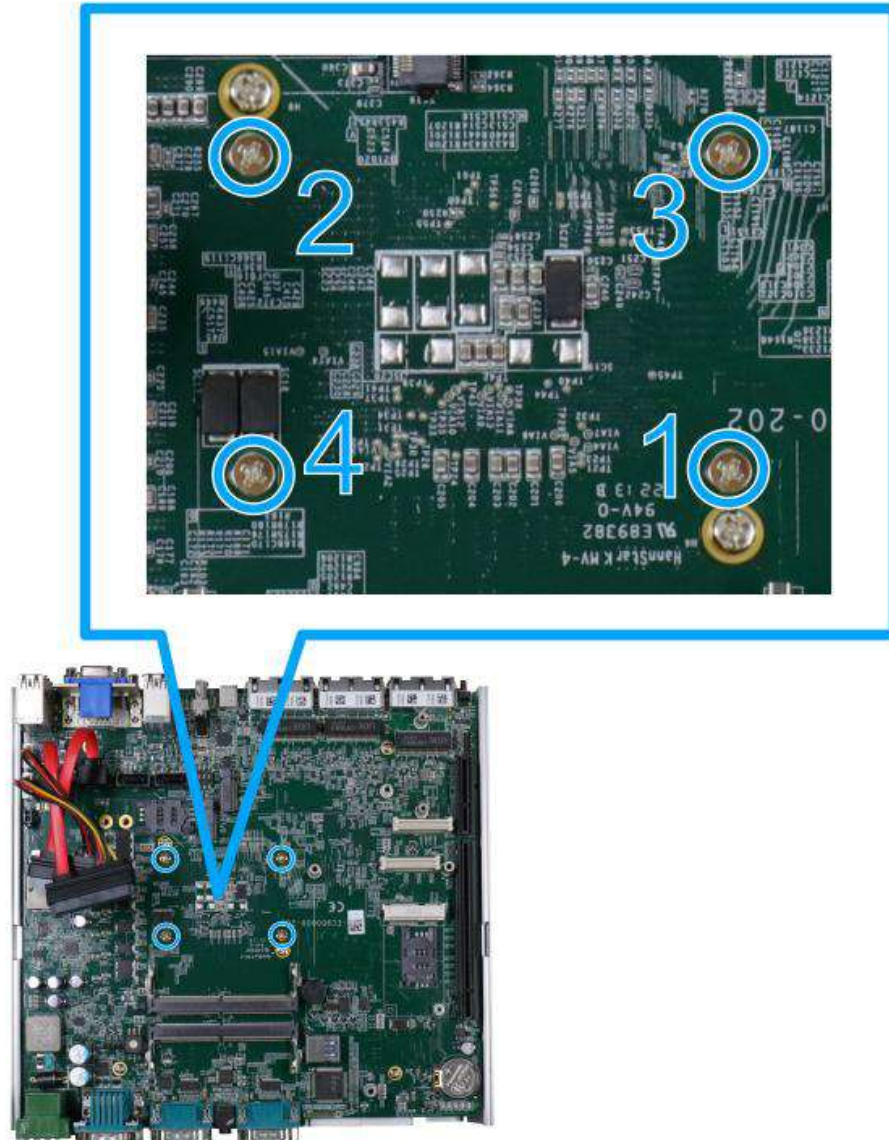

12. Reinstall the system panels, enclosure, and Cassette module when done.
13. If you need to install other components, please refer to respective sections



### 3.2.3 DDR5 SO-DIMM Installation

There are two SO-DIMM memory slots on the motherboard that supports a total maximum of 64GB DDR5-4800. Please follow the procedures below to replace or install the memory modules.

1. Please refer to the section “[Disassembling the System](#)”.
2. Locate the SODIMM memory module slots on the motherboard.

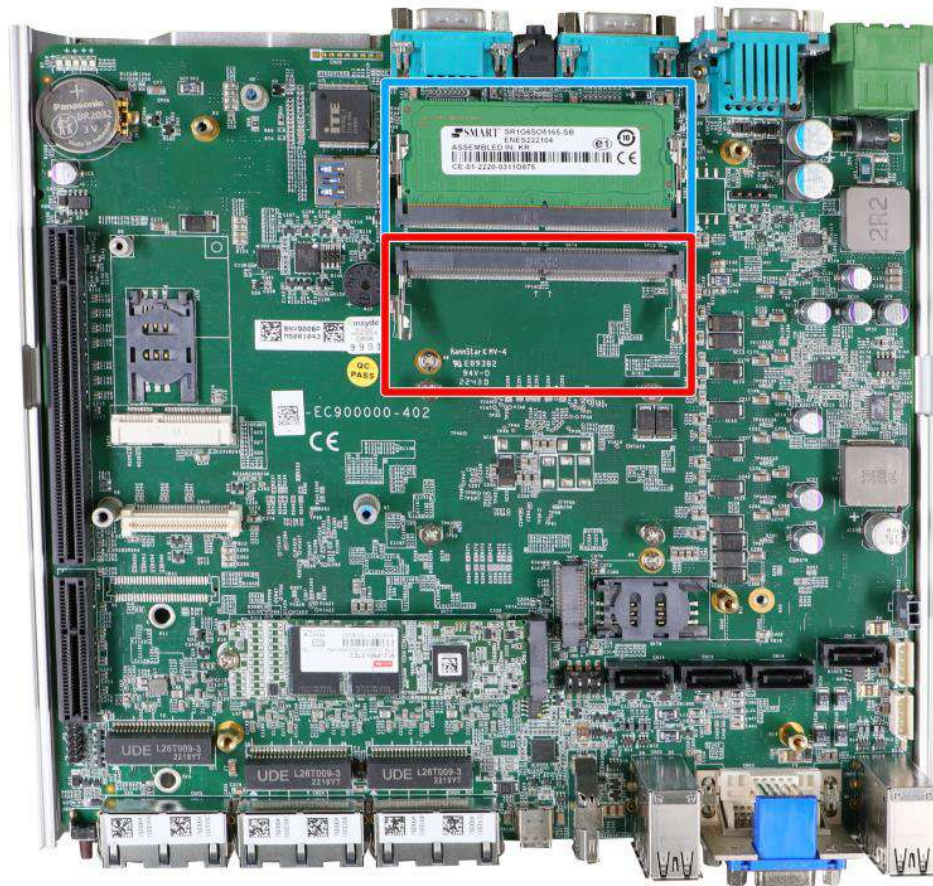

**NOTE**

*If you are installing a memory module, please install into the slot indicated in **blue**. When both slots are occupied, it is recommended that the operating ambient temperature does not exceed 60°C to avoid thermal throttling.*

*When changes are made to DRAM module(s), such as additionally install or remove and reinstall (into the same/ different slot), it will result in approximately a 30 to 60 seconds delay when booting up for the first time after such change(s).*

3. To install the memory module, insert gold fingers into the slot at 45-degree angle, push down on the memory module to clip the module into position.



4. Push the memory module down until it is clipped-in.



5. Repeat steps 3 and 4 to install the other module.
6. Please refer to remove the DRAM module thermal pad protector film off the heatsink/ support frame.

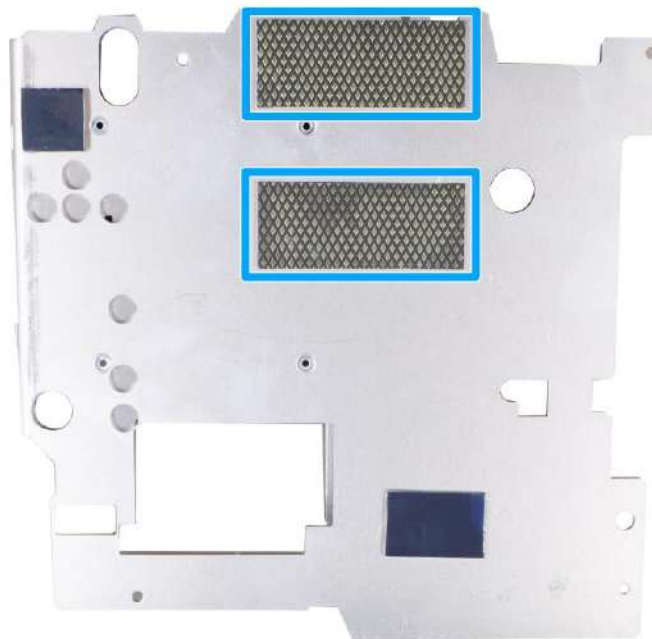

7. [Reinstall the system enclosure](#) and panel when done.
8. If you need to install other components, please refer to respective sections.

### 3.2.4 mPCIe Module, Mini-SIM (2FF) Card and Antenna Installation

The system has mPCIe slots (indicated in **blue**) coupled with Mini-SIM socket (indicated in **red**) for installing 3G/ 4G module. For installation, please refer to the following instructions.

1. Please refer to the section “[Disassembling the System](#)”.
2. Locate the mPCIe and SIM card slots on the motherboard. The MezIO™ module’s SIM card slot can be found underneath the MezIO™ mini-PCIe slot

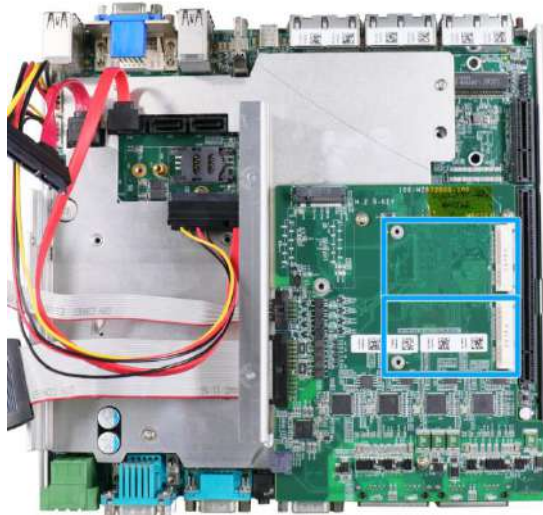

**mini-PCIe slot on MezIO™ module**



**mini-PCIe slot on motherboard  
(underneath MezIO™ card)**

3. Before installing the mPCIe module on the motherboard, you need to insert the Mini-SIM card. Slide the SIM slot holder and lift the SIM card holder. Insert the Mini-SIM card (pins facing up), shut the SIM holder and slide it to lock the SIM card in-place.

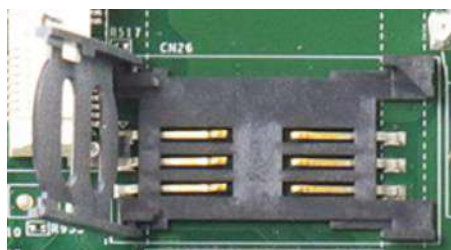

**Slide and lift SIM card holder**



**Insert Mini-SIM card with pins  
facing up**

4. Secure the Mini-SIM card by sliding the holder.

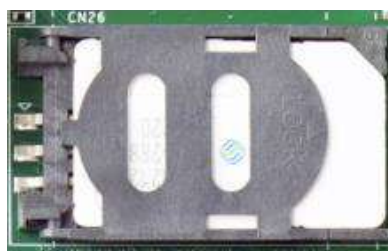



5. Insert the mPCIe module on a 45 degree angle into the mPCIe slot and secure the module.



**Insert on 45 degree angle**

**Secure the module**

6. The SIM slots for mini-PCIe modules on the MezIO™ are located underneath. Remove the screws indicated and gently separate the MezIO™ from the motherboard.

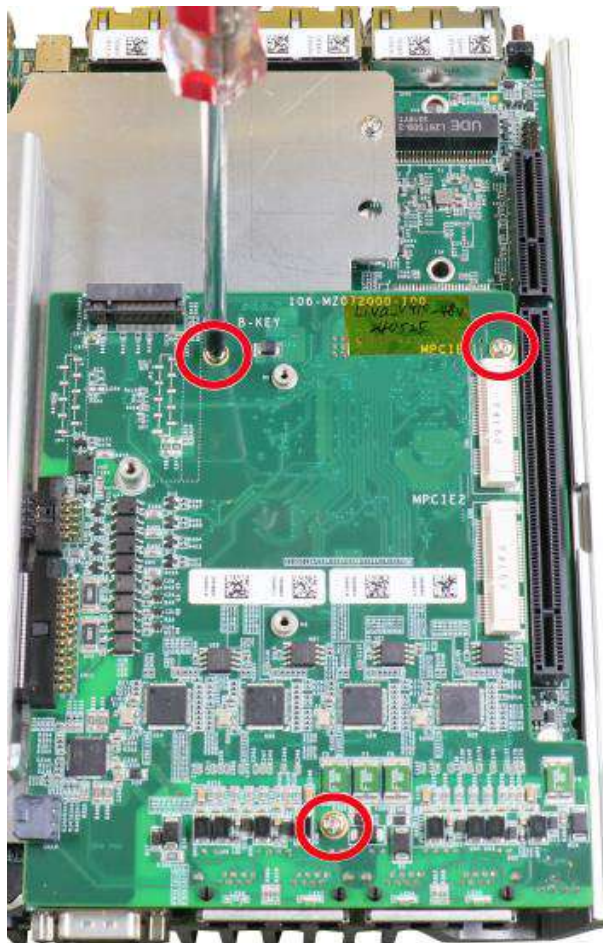

- The SIM sockets utilize push-push mechanism (push-to-install and push-to-retrieve).

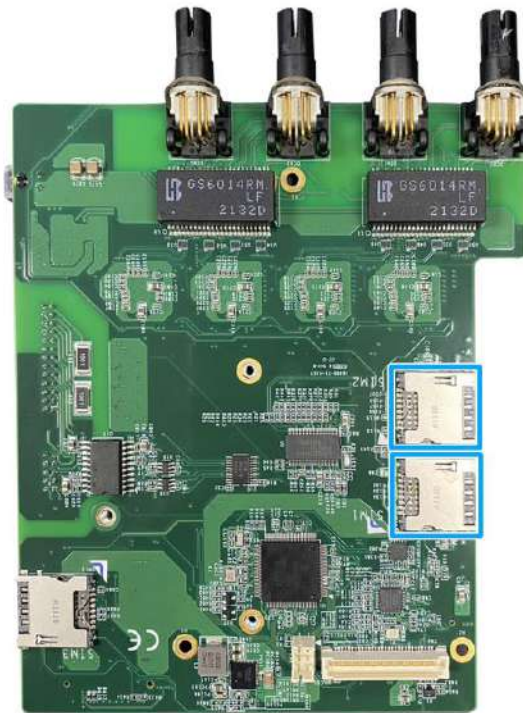

**mPCIe SIM slots underneath**

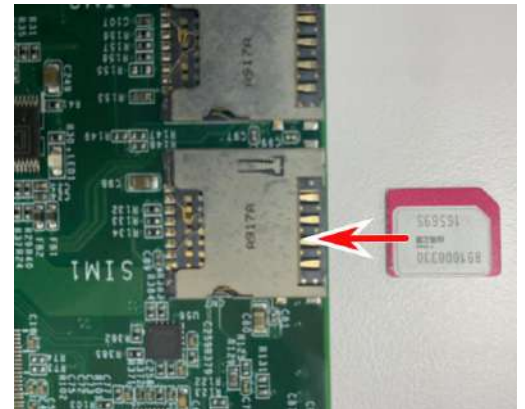

**SIM card insertion orientation**

- Clip on the IPEX-to-SMA cable to the module and secure the antenna to the system panel. Please refer to the module's manual for clip-on connection.



**Clip on IPEX-to-SMA cable**

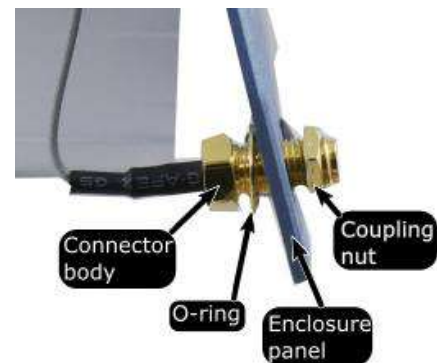

**Secure antenna to system panel**

- [Reinstall the system enclosure](#) and panel when done.
- If you need to install other components, please refer to respective sections.

### 3.2.5 M.2 2242 (B Key) Module and Micro-SIM (3FF) Card Installation

The system has two M.2 slots (indicated in **blue**) for installing 5G/ 4G or WiFi modules. The M.2 slot on the motherboard has a Micro-SIM card slot (indicated in **red**) while the SIM slot for the M.2 module can be found underneath the MeziO™ module. For installation, please refer to the following instructions.

1. Please refer to the section “[Disassembling the System](#)”.
2. Locate the M.2 2242 (B Key) and SIM card slots on the MeziO™ and on the motherboard. The M.2 slot on the motherboard offers a copper standoff to secure onto the motherboard into the **red arrow** location for an M.2 2242/ 3042 module, or into the **blue arrow** location for an M.2 3052 module.

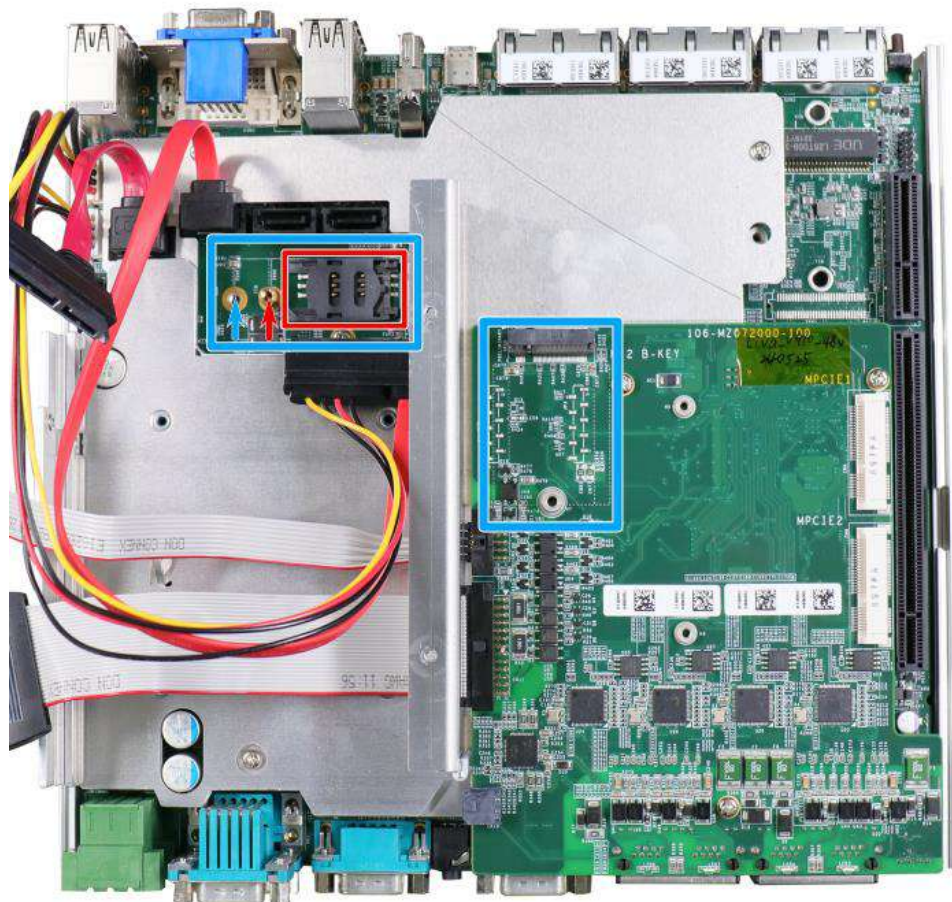

**M.2 slot on MeziO™ module and on the motherboard (accessible without removing heatsink/ support frame)**



- Before installing the M.2 module on the motherboard, you need insert the SIM card. Slide the SIM slot holder and lift the SIM card holder. Insert the Mini-SIM card (pins facing up), shut the SIM holder and slide it to lock the SIM card in-place.

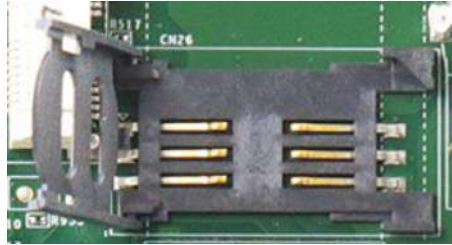

Slide and lift SIM card holder

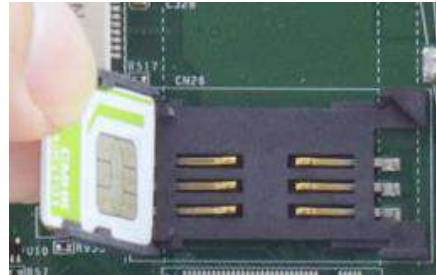

Insert Mini-SIM card with pins facing up

- Secure the Mini-SIM card by sliding the holder.

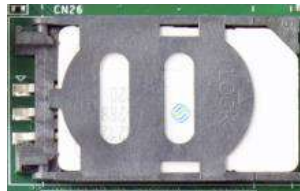

- Insert the module on a 45 degree angle.



- Gently press down and secure the module with an M3 P-head screw.



7. For the M.2 module on the MezIO module, the SIM slot is located underneath. Remove the MezIO™ module by removing the screws indicated, and gently lift to separate the module from the motherboard.

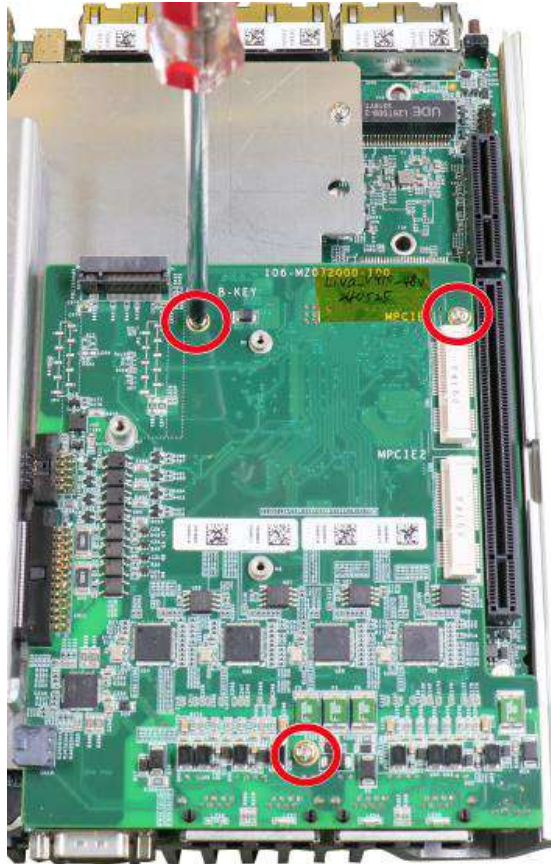

8. The The SIM slot is located underneath. The SIM socket utilizes push-push mechanism (push-to-install and push-to-retrieve).

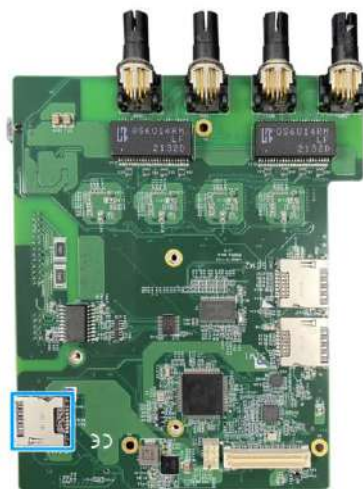

**SIM slot underneath**

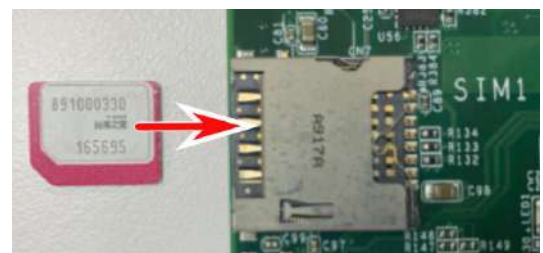

**SIM card insertion orientation**

- Clip on the IPEX-to-SMA cable to the module and secure the antenna to the system panel.  
Please refer to the module's manual for clip-on connection.



**Clip on IPEX-to-SMA cable**

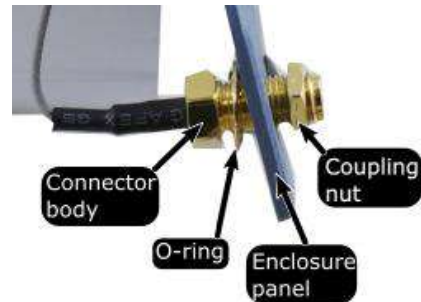

**Secure antenna to rear panel**

- [Reinstall the system enclosure](#) and panel when done.
- If you need to install other components, please refer to respective sections.



### 3.2.6 M.2 2280 NVMe SSD Installation

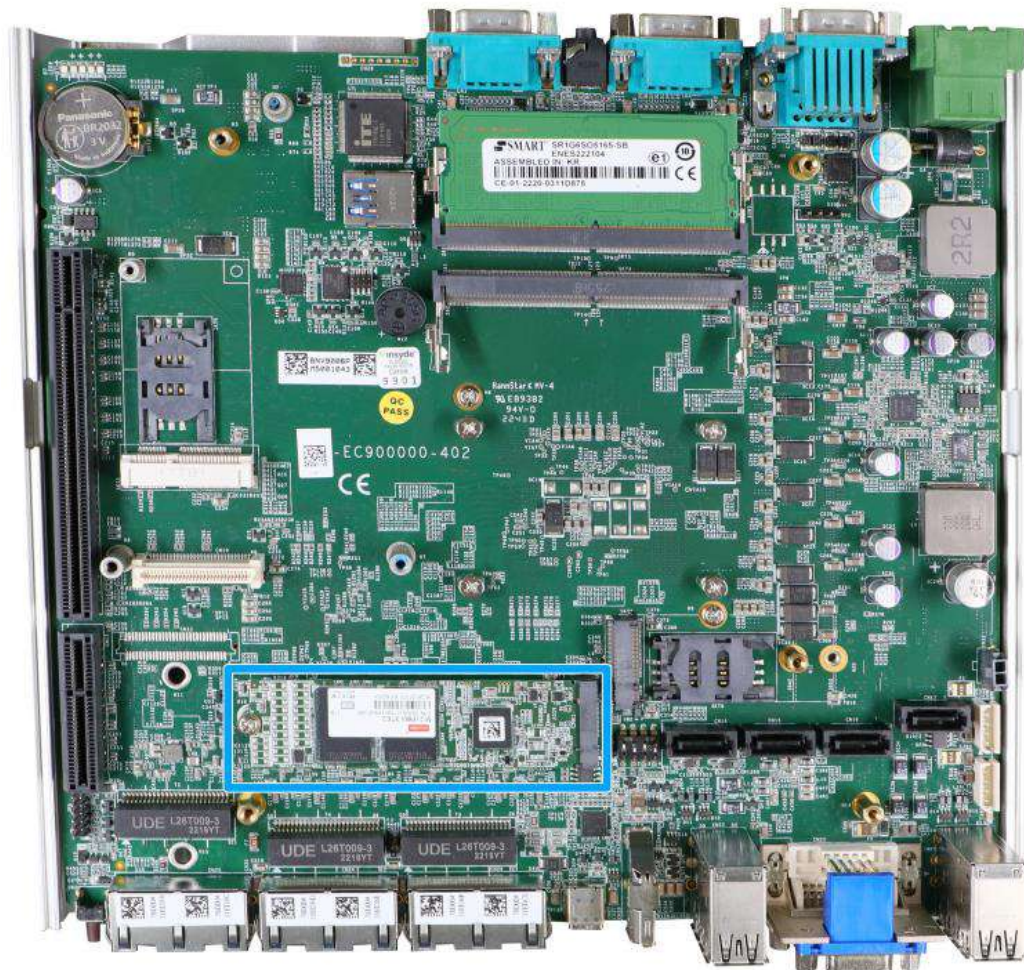

The system has a x4 PCIe M.2 2280 slot for you to install an NVMe SSD for the ultimate performance or an Intel® Optane™ memory to accelerate the read/ write performances of traditional hard disk drive. An NVMe SSD offers exceptional performance over 2.5" SSDs while Intel® Optane™ memory can dramatically boost your traditional hard disk drives' read/ write performances. For installation, please refer to the following instructions.

1. Please refer to the section "[Disassembling the System](#)", you may not need to completely dismantle the system to gain access to the M.2 slot.
2. Insert the module on a 45 degree angle.



3. Gently press down and secure the module with an M3 P-head screw.



4. Please remember to remove the thermal pad protector film off the heatsink/ support frame for NVMe SSD.

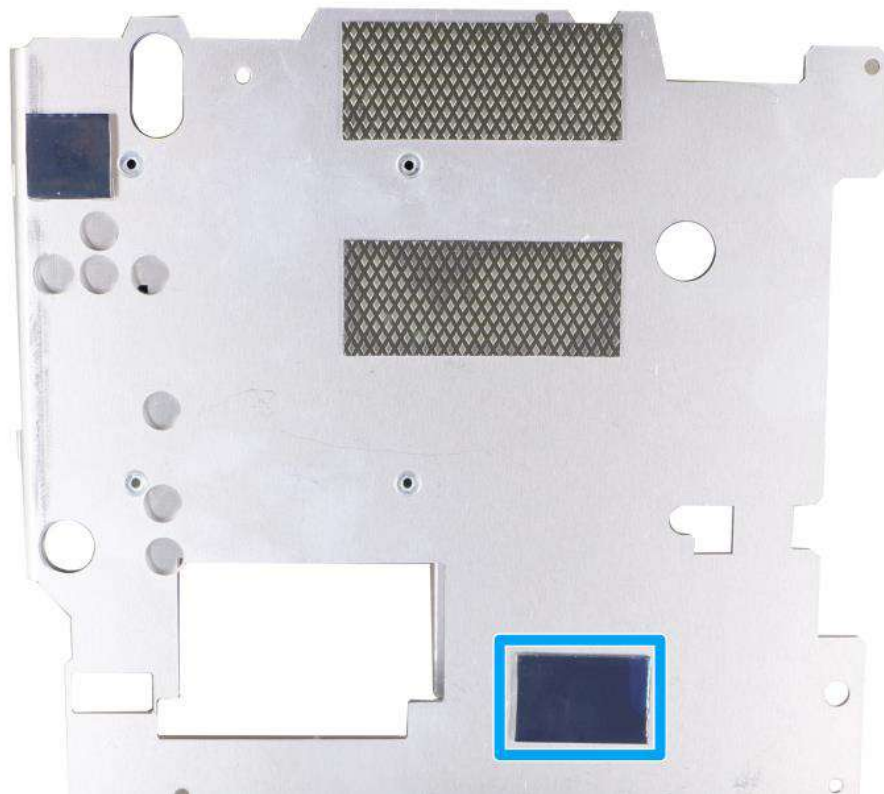

5. [Reinstall the system enclosure](#) and panel when done.
6. If you need to install other components, please refer to respective sections.



### 3.2.7 MezIO™ Module Installation

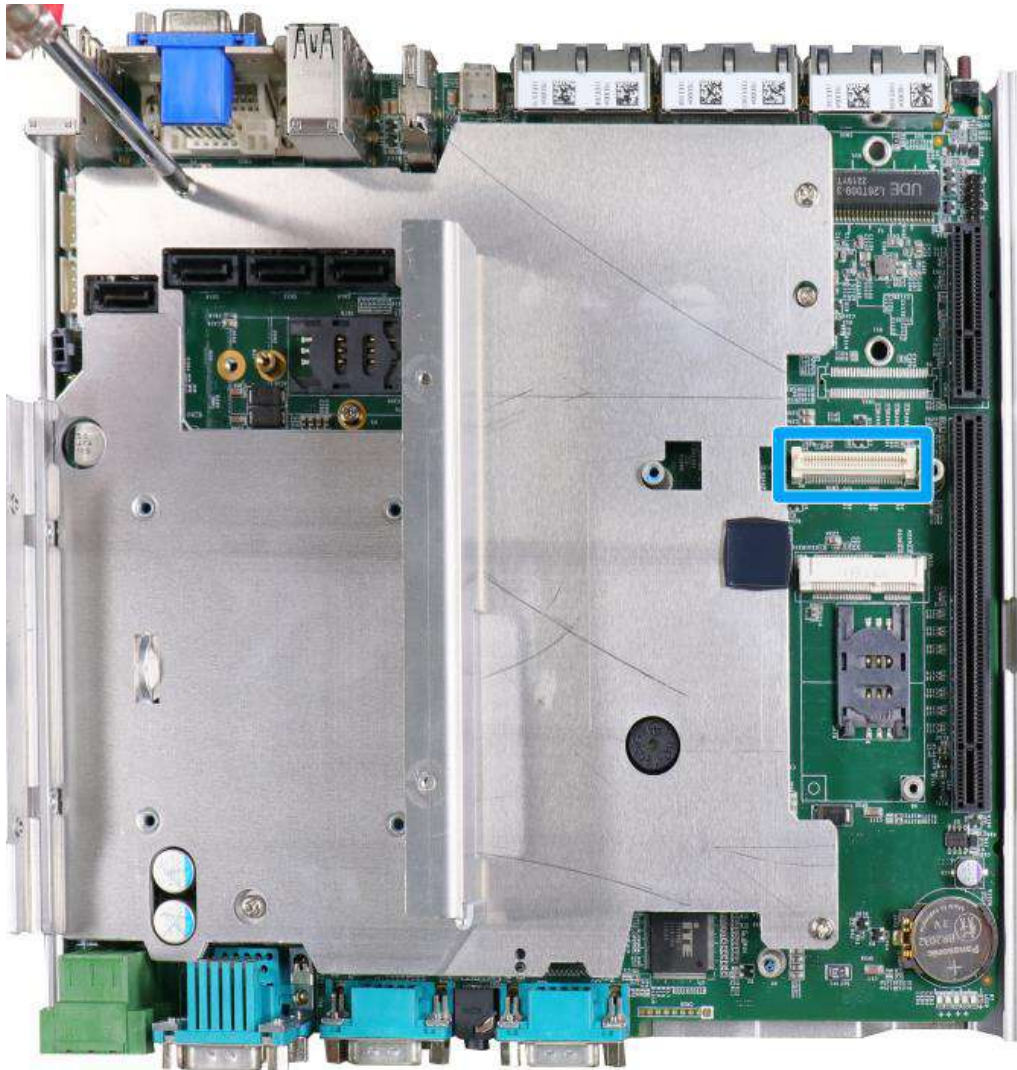

MezIO™ is an innovative interface designed for integrating application-oriented I/O functions into an embedded system. It offers computer signals, power rails and control signals via a high-speed connector. MezIO™ is also mechanically reliable benefited from its 3-point mounted mezzanine structure. A MezIO™ module can leverage these signals to implement comprehensive I/O functions.

The system incorporates MezIO™ interface and universal mechanical design to accommodate Neosys' standard MezIO™ modules. For customers who want to develop their own MezIO™ module, Neosys provides MezIO™ design documents on a NDA basis. Please contact Neosys for further information.

1. Please refer to the section "[Disassembling the System](#)" to gain access to the MezIO™ interface.

2. The MeziO™ module is secured by the three stand-mounts indicated in the illustration below.



3. Gently lower the MeziO™ module onto the three stand-mounts while matching the MeziO™ interface. Secure the module using three screws supplied.

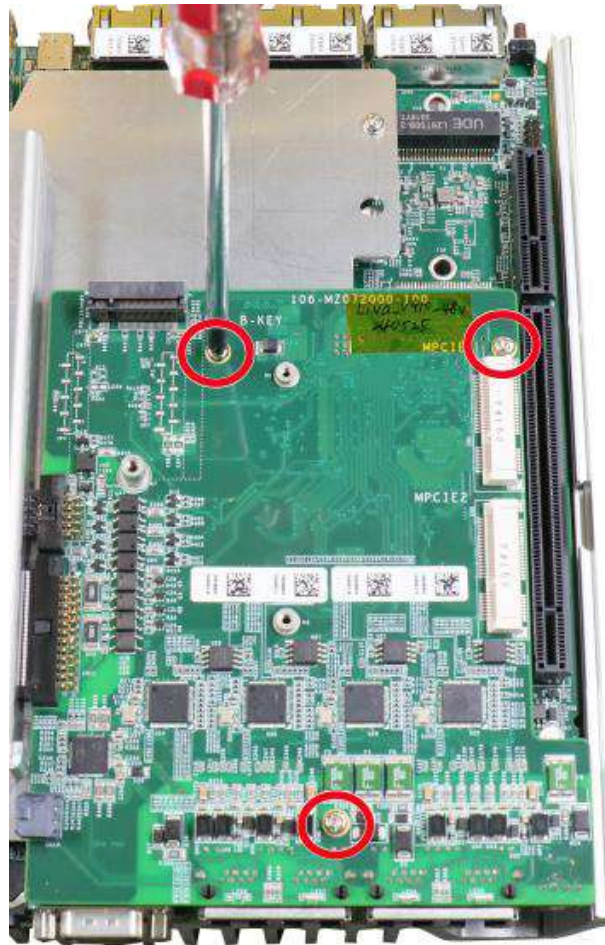

4. [Reinstall the system enclosure](#) and panel when done.
5. If you need to install other components, please refer to respective sections.



### 3.2.8 HDD/ SSD Installation (Nuvo-9100 VTC Series Systems)

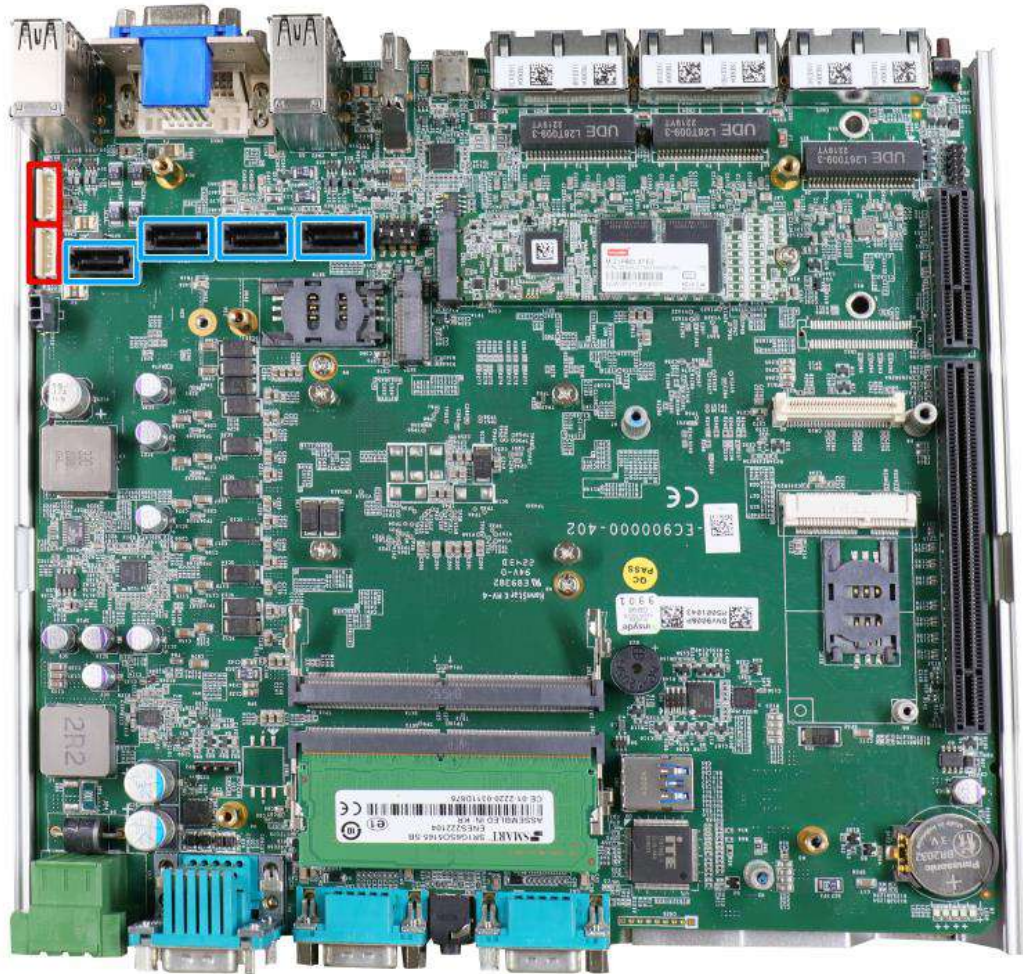

The system has SATA ports (indicated in blue) and four-pin power connectors (indicated in red). The SATA and power cables should already be connected on the motherboard so users only need to install the HDD/ SSD. Please refer to the following instructions on how to install 2.5" SATA HDD/ SSD.

1. Turn the system upside-down and remove the three screws indicated in the illustration below and lift the tray out of the system.



2. Take the HDD/ SSD

thermal pad out of the accessory box and place it in the middle of the tray. Remove the protective film covering the HDD/ SSD thermal pad.



3. Secure the HDD/ SSD and match the SATA connector end to the side with two screw holes (indicated in **blue**), secure the HDD/ SSD with the supplied flathead screws (4 per drive).



4. At the tray opening, you should be able to locate the 22-pin SATA cable, connect it to the installed HDD/ SSD.





5. Gently put the tray back into the system with the connector side being inserted into the system first and secure the tray with three screws.

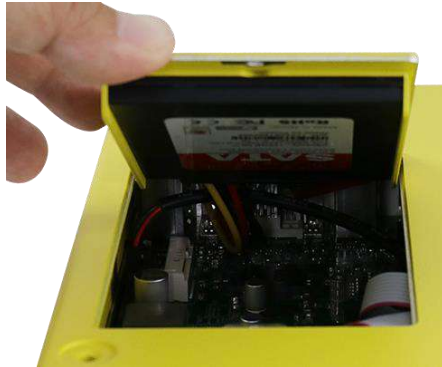

**Reinsert the tray**



**Secure the tray**

6. If you need to install other components, please refer to respective sections.

### 3.2.9 HDD/ SSD Installation to Hot-swappable Tray

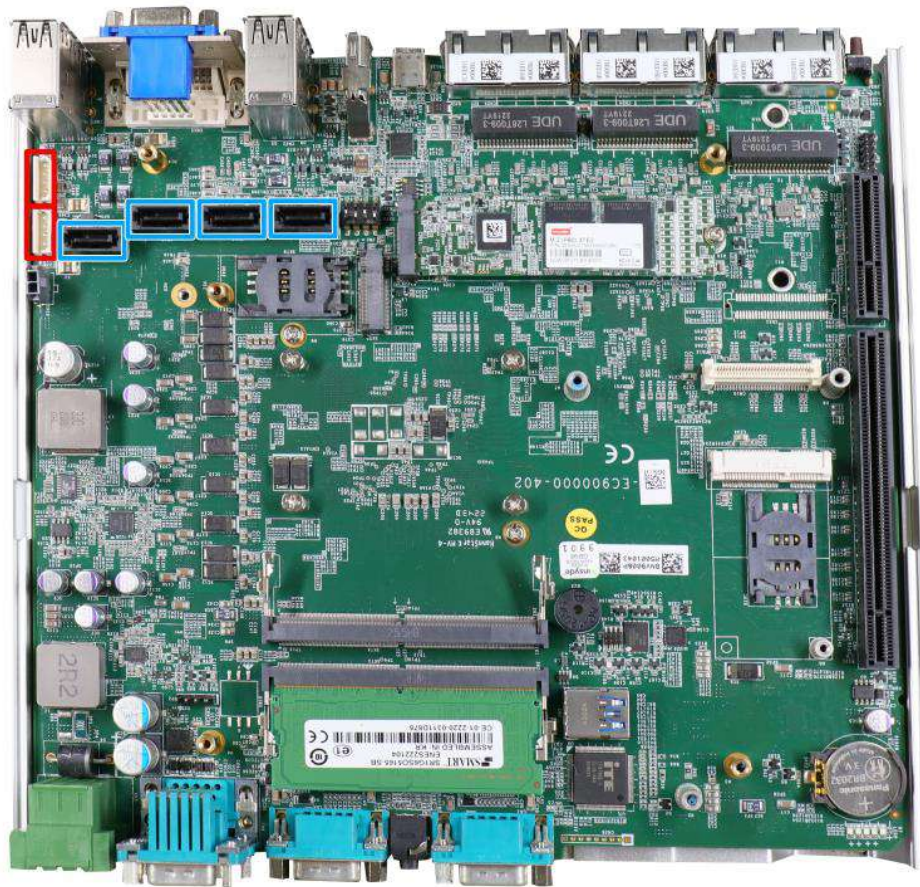

The system has SATA ports (blue) and four-pin power connectors (red). The SATA and power cables should already be connected on the motherboard so users only need to install the 2.5" SATA HDDs/ SSDs to the front hot-swappable tray(s). For Nuvo-9100VTC systems, there is also an internal drive that can be coupled to configured into RAID 0 or 1 storage. If you previously disconnected the SATA and power cables, please reconnect them before continuing with this installation procedure.

1. Pull the lever on the 2.5" external hot-swappable slot to swing open the cover.



2. With the label side facing upward, insert the SATA connector side of the 2.5" HDD/ SSD into the slot first. You may feel resistance when the SATA connectors meet, push it in firmly until the 2.5" HDD/ SSD is fully inserted into the slot.



3. Push the lever into the 2.5" slot until it snaps into position. A key is provided (in accessory box) to lock the external slot.



**Key in accessory box**

**2.5" HDD/ SSD slot lock**

4. Repeat the steps above if you wish to install a hard drive into the other tray.

### 3.2.10 Ethernet/ PoE+ Port Panel Screw Fix

The system's RJ45 Ethernet ports have panel screw fix holes (indicated in blue circles) to secure the cable connection.



#### NOTE

Ports underneath the status LEDs have only a fix hole at the bottom.

1. To install and make use to the panel screw fix connection, you must acquire panel screw fix cables such as the cable shown below.



2. Simply insert the RJ45 connector into the RJ45 port and secure the top and bottom screws using your fingers or a screw driver.



### 3.2.11 PCIe Card Installation into Cassette Module (Nuvo-9200VTC)

**WARNING**

To reduce the risk of damage, **DO NOT** remove PCIe card from the antistatic bag (or its original packaging) before it is ready to be installed into the Cassette module!



The Cassette module provides a separated compartment to accommodate an add-on card. It compartmentalizes the heat generated and effectively manages thermal conditions of both the system and add-on card(s). The modular design reduces the complexity of installing and replacing add-on card to offer system stability and reliability.

To install a PCIe card into the Cassette module, please refer to the following procedure:

1. Turn the system upside-down and remove the four screws.

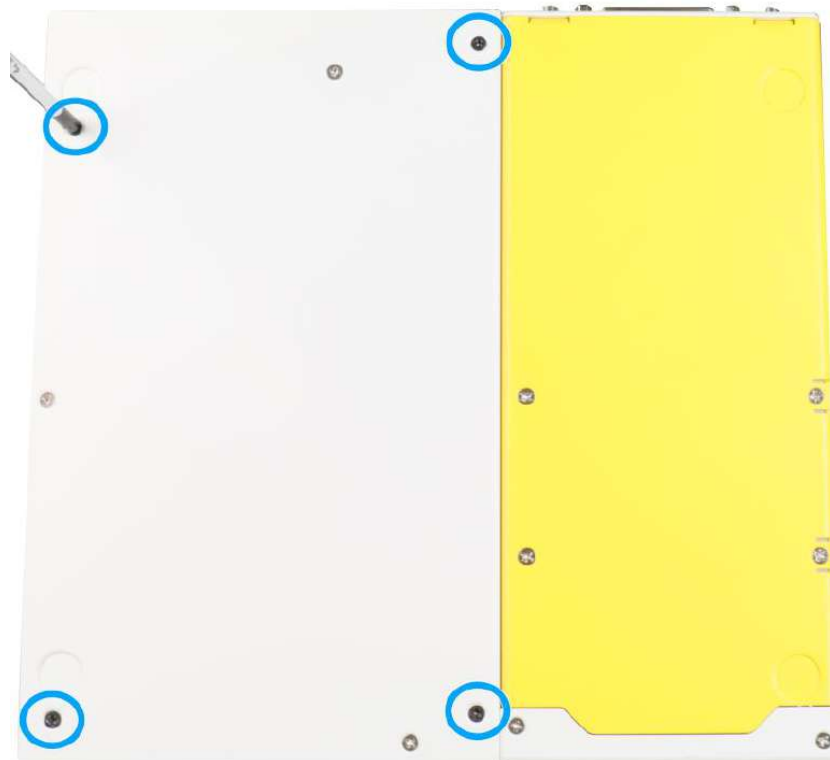



2. Gently wiggle the Cassette module and separate it from the system enclosure.



3. Remove the screws to open the Cassette cover.



4. Place the cube spacers provided onto the back of the PCIe card you wish to install into the Cassette module to ensure the PCIe card and the enclosure does not come in contact.

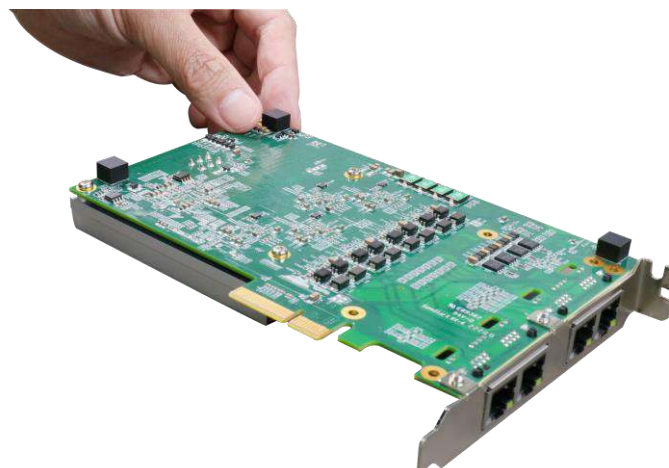

- Remove the bezel cover (indicated in **blue circle**) and insert the card into the PCIe/ PCI slot while making sure the bezel is properly inserted into the notch and the card is secured in place with screw.



**Remove bezel cover**

**Make sure the card is inserted into the notch and secured with a screw**

- Secure the screw indicated in the **blue circle**.



7. Gently lower the Cassette module back onto the system enclosure and secure the module onto the system enclosure by securing the following screws.

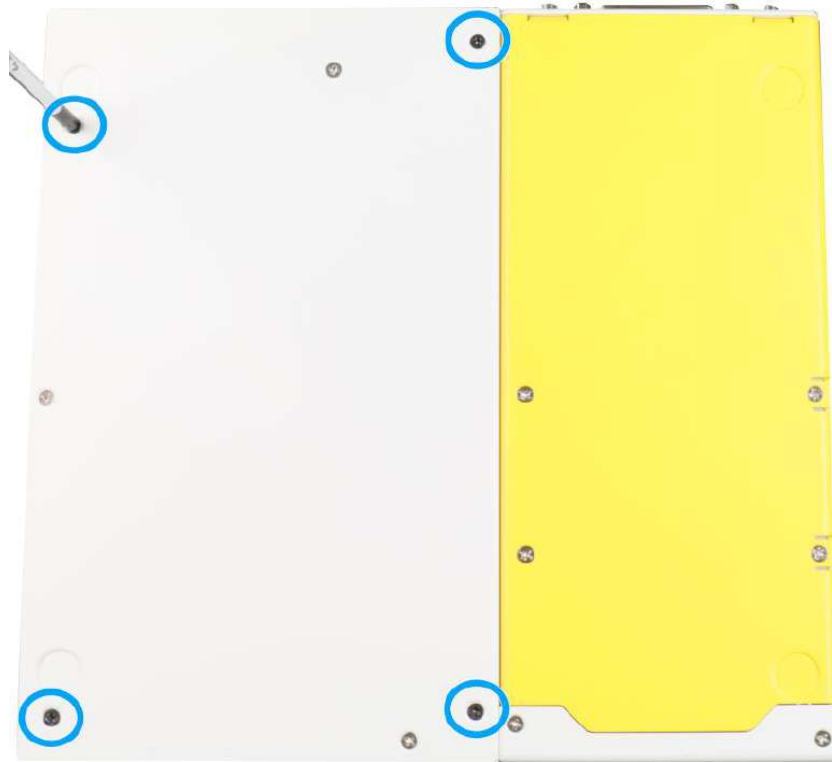

### 3.3 Installing the System Enclosure

1. Once you have install the internal module(s), please make sure you have also installed the heatsink/ support frame.

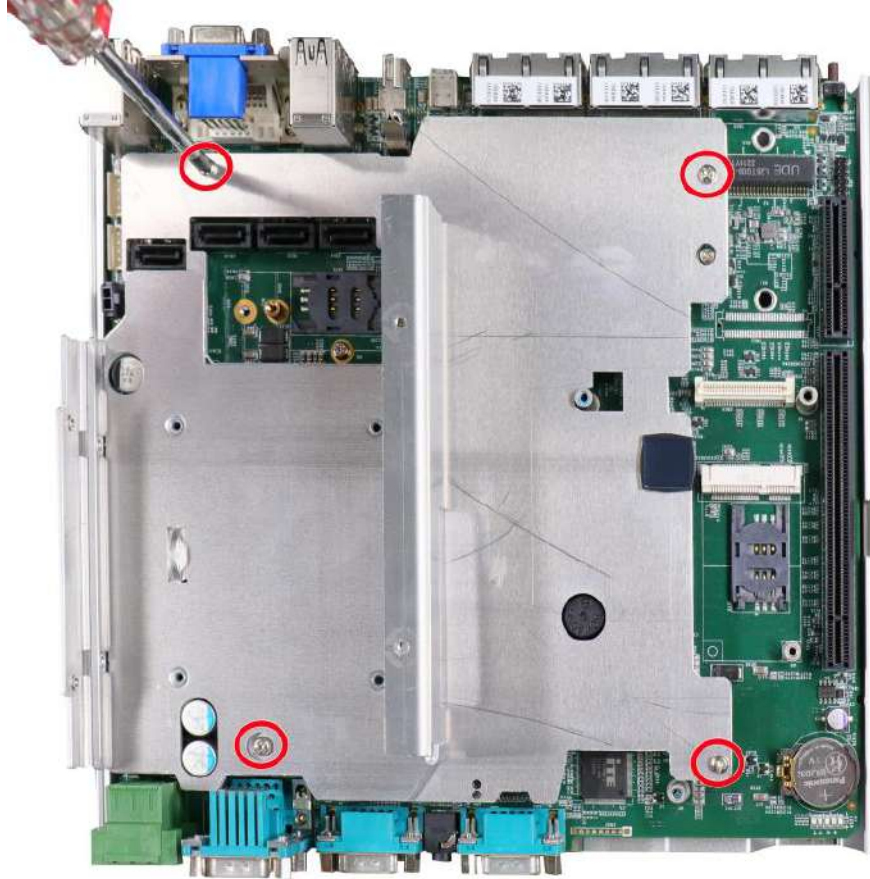

- To reinstall the system enclosure, place the bottom panel on top of the motherboard while making sure both sides are inserted into the heatsink (indicated in **blue**).

**NOTE**

*Please connect the 22-pin SATA cable connected to the 2.5" hot swappable tray before installing the bottom panel.*

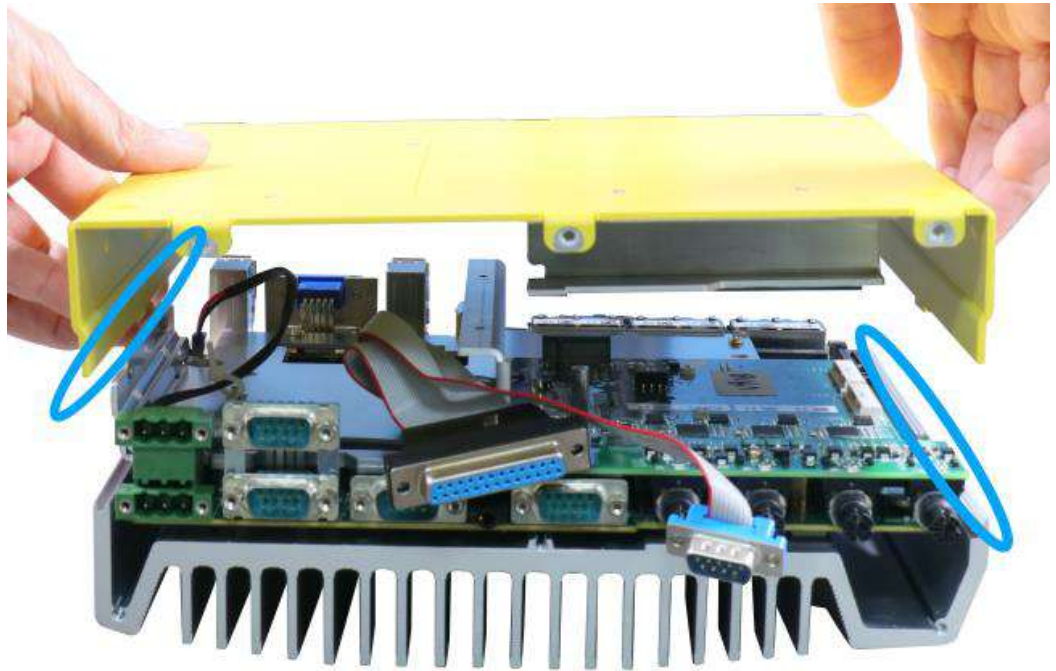



3. Install the front panel and secure screws indicated in blue.



**Nuvo-9200VTC series systems**



**Nuvo-9100VTC series systems**

4. Install the rear panel and secure screws indicated in **blue**.



**Nuvo-9200VTC series systems**



**Nuvo-9100VTC series systems**

5. For Nuvo-9100VTC and Nuvo-9200VTC systems, make sure the O-ring seal are re-inserted when re-installing the rear panel.



- Secure the screws on the left side (facing the rear COM port panel).

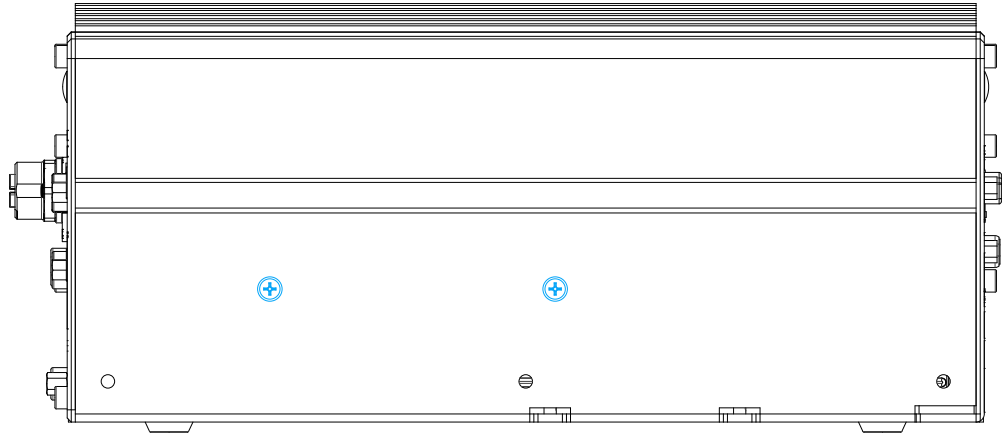

**Nuvo-9200VTC series systems**

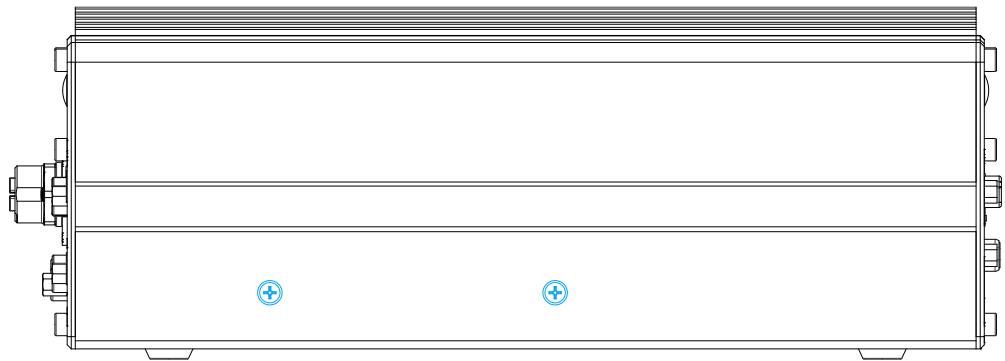

**Nuvo-9100VTC series systems**

7. Install the Cassette module and secure screws indicated in **blue**.



**NOTE**

*Not applicable to Nuvo-9100VTC systems.*

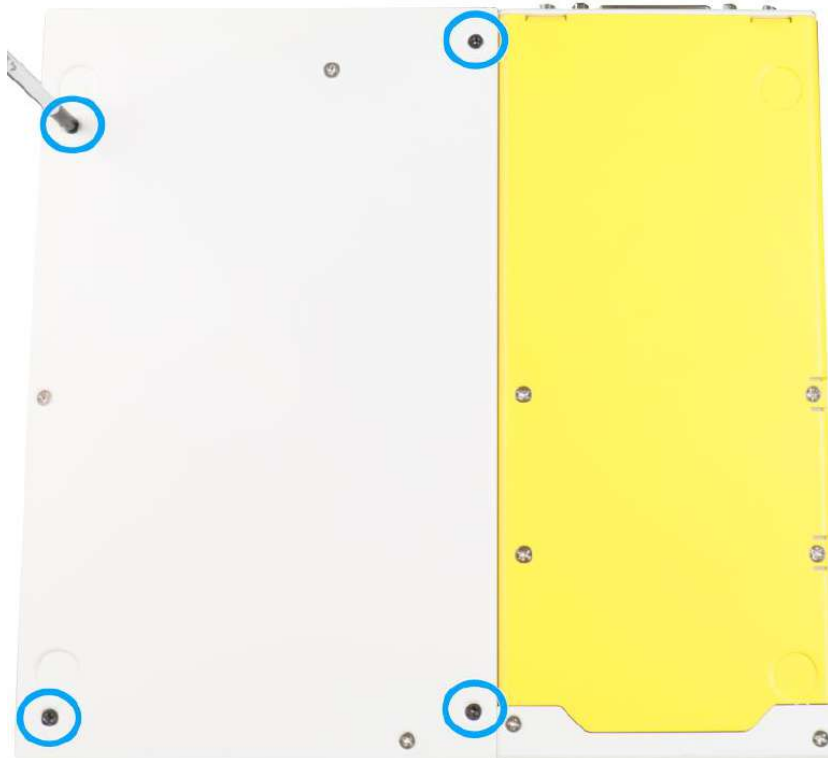

### 3.4 Damping Bracket Installation



You will need to remove the four (4) rubber stands at the bottom of the enclosure if they have been attached.

#### 3.4.1 Nuvo-9100VTC Series Damping Bracket Installation

To install the system as a wall mount device, please refer to the following instructions.

1. Take out the **damping bracket** and **M4 screws** out of the accessory box. Fix the damping bracket to the system enclosure using M4 screws. Place the system on a flat surface and secure it using **M4 screws**.

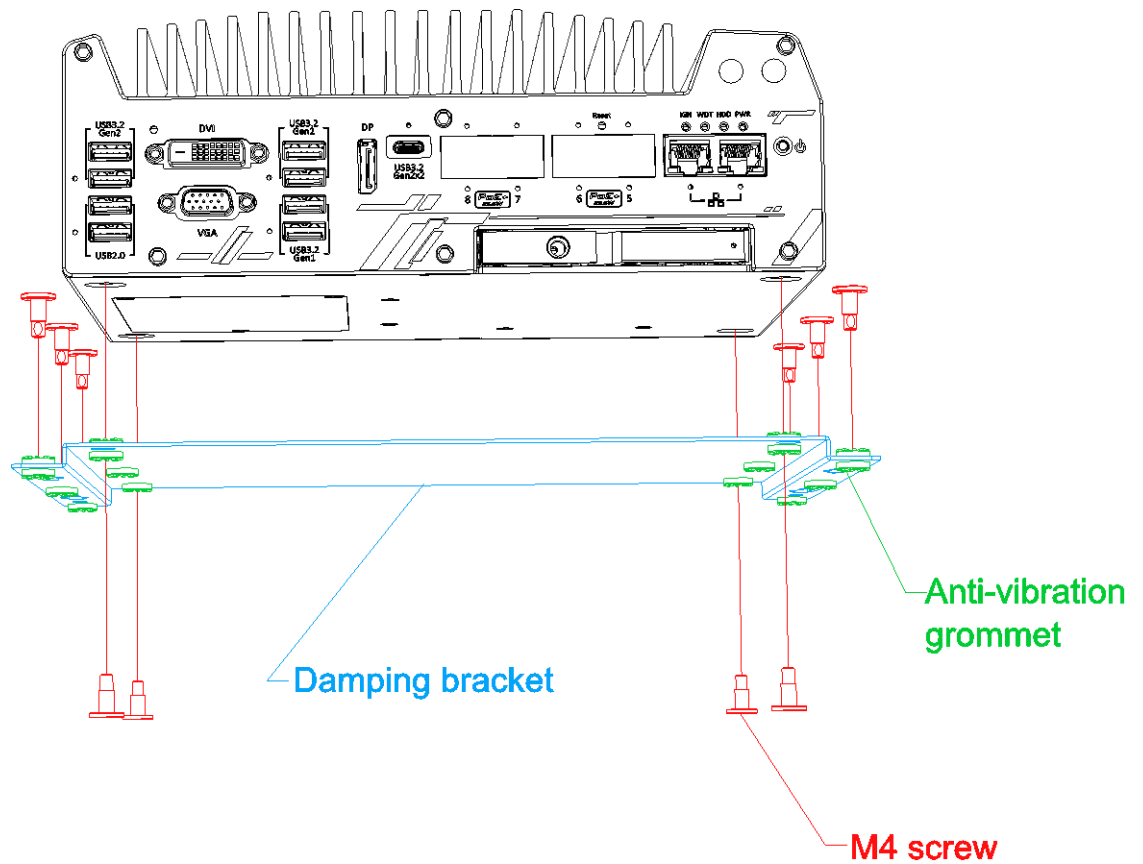



### 3.4.2 Nuvo-9200VTC Series Damping Bracket Installation

To install the system as a wall mount device, please refer to the following instructions.

1. Take out the two **damping brackets** and **M4 screws** out of the accessory box. Fix the damping brackets to the two sides of the system enclosure using M4 screws.

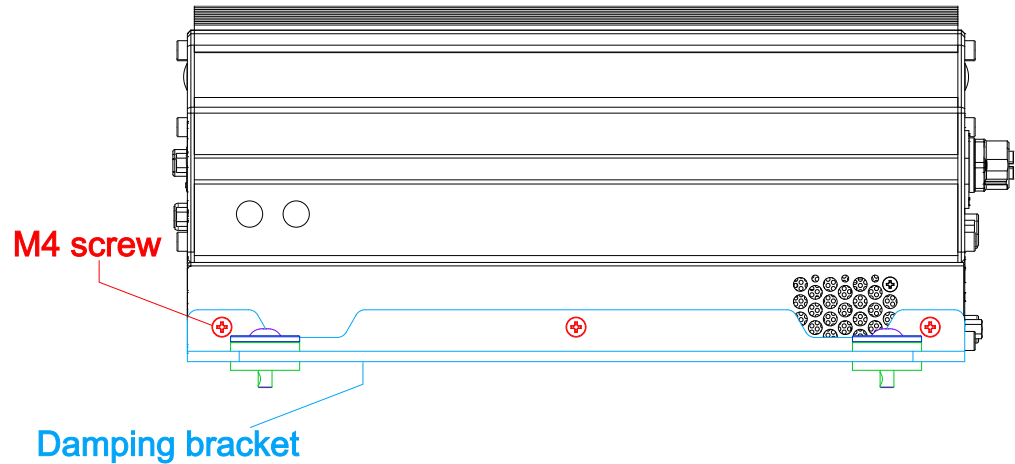

2. Place the system on a flat surface, insert the **sleeves** into the **anti-vibration grommets** and secure it with **M4 screws**.

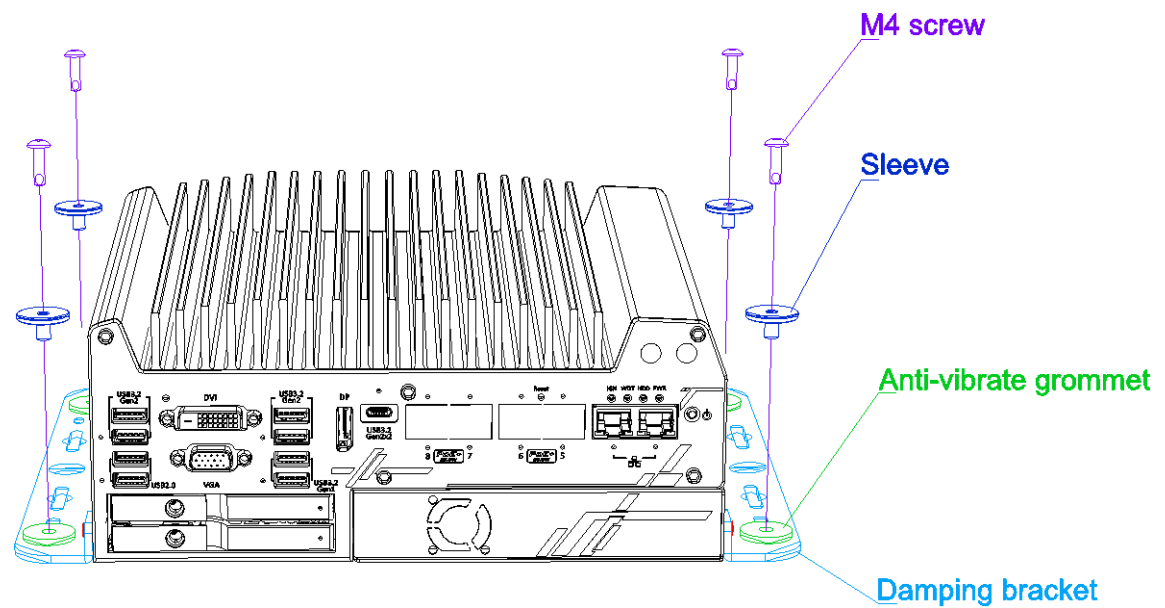

### 3.5 Powering On the System

There are three methods to power on the system

- Pressing the power button
- Using an external non-latched switch by connecting to the remote on/ off plug
- Sending a LAN packet via Ethernet (Wake-on-LAN)

Powering on using the [ignition power control](#) is described in a designated section.

#### 3.5.1 Powering On Using the Power Button

This is the simplest way to turn on your system. The power button on the front panel is a non-latched switch and behaves as the ATX-mode on/off control. With DC power connected, pushing the power button will turn on the system and the PWR LED indicator will light up. Pushing the button when system is on will turn off the system. If your operating system supports ATX power mode (i.e. Microsoft Windows or Linux), pushing the power button while the system is in operation will result in a pre-defined system behavior, such as shutdown or hibernation.

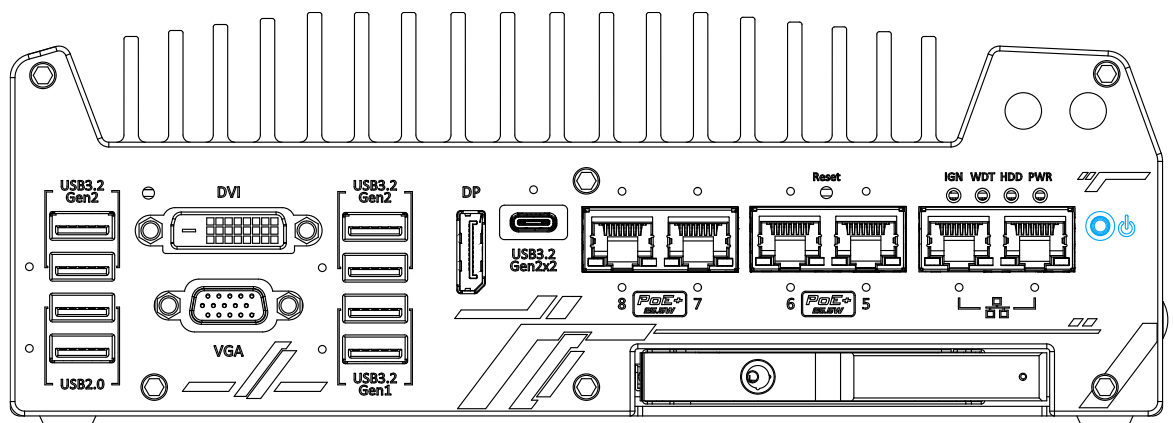

### 3.5.2 Powering On Using External Non-latched Switch

If your application demands the system to be placed inside a cabinet, you may use an external non-latched switch to power on/ off the system. The system provides a 3-pin “Remote On/ Off” plug for connecting a non-latched switch and acts as the ATX-mode power on/off control switch. The external non-latched switch acts exactly the same as the power button on the front panel. To setup and power on/ off the system using an external non-latched switch (ATX-mode), please follow the steps described below.

1. Acquire a non-latched switch with 3-pin plug.
2. Connect the non-latched switch to the Remote On/ Off plug.

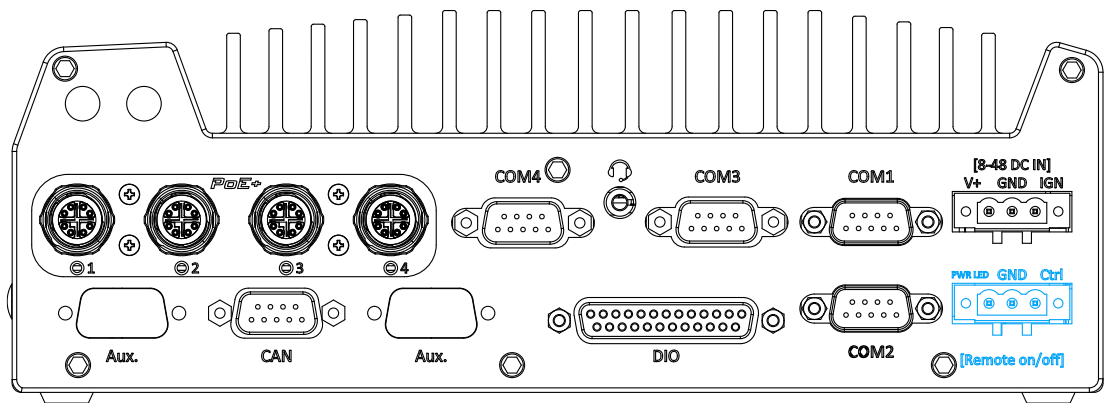

3. With DC power connected, pushing the power button will turn on the system and the PWR LED indicator will light up. Pushing the button when system is on will turn off the system. If your operating system supports ATX power mode (i.e. Microsoft Windows or Linux), pushing the power button while the system is in operation will result in a pre-defined system behavior, such as shutdown or hibernation.

### 3.5.3 Powering On Using Wake-on-LAN

Wake-on-LAN (WOL) is a mechanism to wake up a computer system from a S5 (system off with standby power) state via issuing a magic packet. The system's Wake-on-LAN compatible GbE port is shown below.

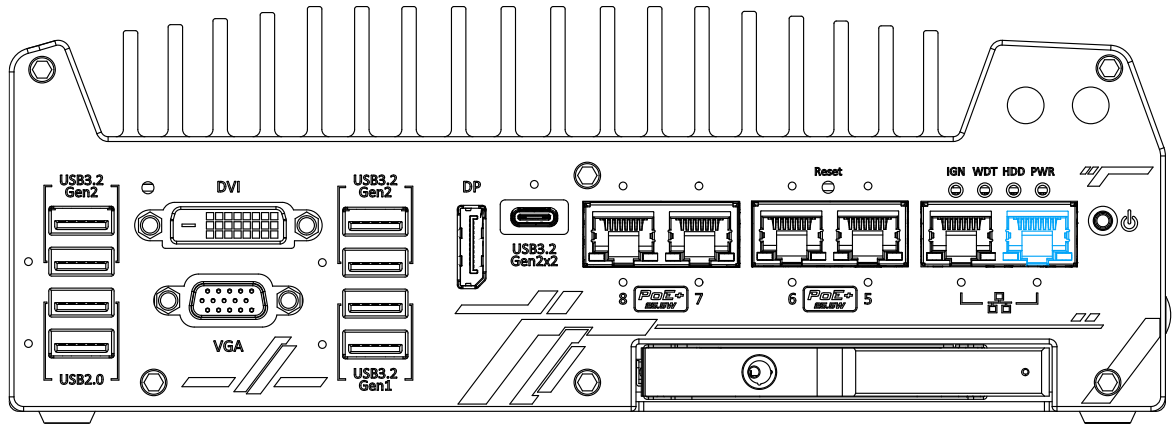

 **NOTE**

*Please make sure the Intel® chipset and Ethernet driver has been properly installed prior to setting up WOL function.*

To enable WOL function, please set up WOL settings in the BIOS and in the operating system by follow the steps described below.

1. When the system boots up, press F2 to enter BIOS setup utility.
2. Go to the **[Power]>[Wake On LAN]** and set it to **[Enabled]**.
3. Press F10 to **“Save changes and exit BIOS”** and allow the system boot into the operating system.
4. Once booted into the Windows system, press **“Windows key + E”**, right-click on **“Network>Properties>Change adapter settings”**. Locate and double-click on the adapter Intel® I219 Gigabit Network Connection, click on **Configure...**
5. Click on the **Power Management** tab and check the following options. Click on OK when done.

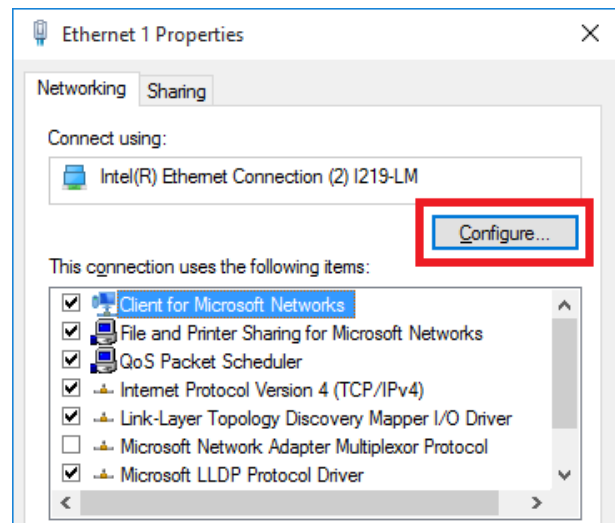

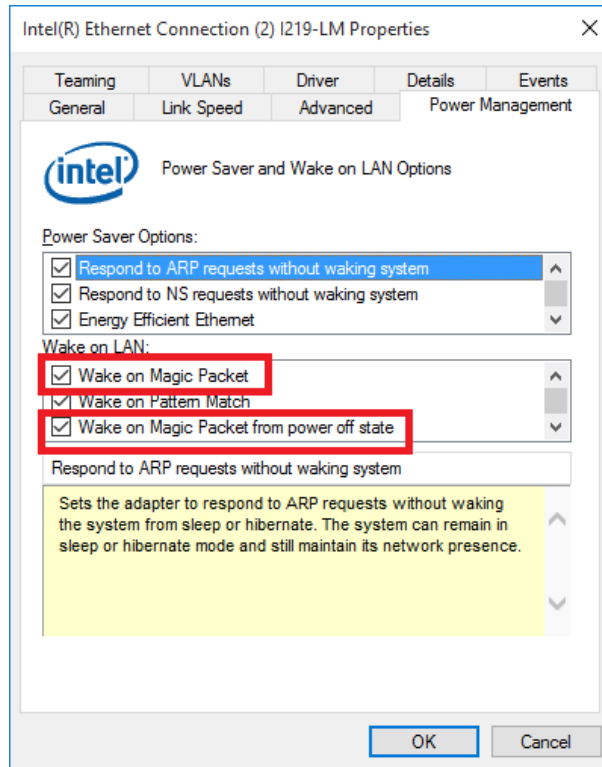

### Magic Packet

The magic packet is a broadcast frame containing anywhere within its payload 6 bytes of all 255 (FF FFFFFFFF in hexadecimal), followed by sixteen repetitions of the target computer's 48-bit MAC address.

For example, NIC's 48-bit MAC Address is 78h D0h 04h 0Ah 0Bh 0Ch

DESTINATION SOURCE MISC

FF FFFFFFFF

78 D0 04 0A 0B 0C 78 D0 04 0A 0B 0C

78 D0 04 0A 0B 0C 78 D0 04 0A 0B 0C

78 D0 04 0A 0B 0C 78 D0 04 0A 0B 0C

78 D0 04 0A 0B 0C 78 D0 04 0A 0B 0C

78 D0 04 0A 0B 0C 78 D0 04 0A 0B 0C

78 D0 04 0A 0B 0C 78 D0 04 0A 0B 0C

78 D0 04 0A 0B 0C 78 D0 04 0A 0B 0C

78 D0 04 0A 0B 0C 78 D0 04 0A 0B 0C

MISC      CRC

There are some free tools available on Internet that can be used to send a magic packet.

Please refer to the following link to understand more about [Magic Packet](#).



## 3.6 Ignition Power Control

The ignition power control module for in-vehicle applications is a MCU-based implementation that monitors the ignition signal and reacts to turn on/off the system according to predefined on/off delay. Its built-in algorithm supports other features such as ultra-low power standby, battery-low protection, system hard-off, etc. In this section, we'll illustrate the principle of ignition power control and operation modes.

### 3.6.1 Principles of Ignition Power Control

The basic concept of ignition power control module is to control the timing correlation between ignition signal and system power status. A typical timing correlation is described in following diagram.

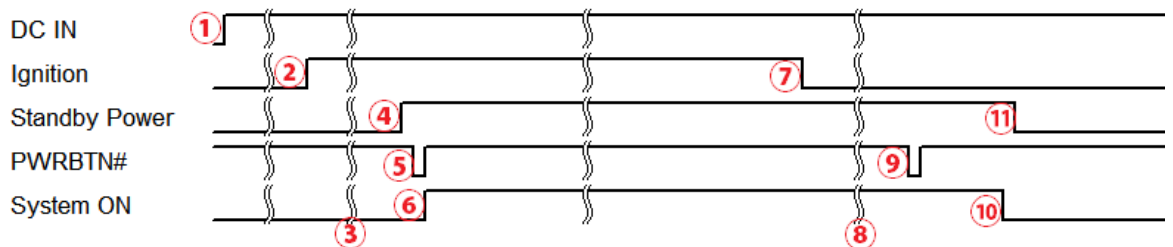

1. When DC power is supplied to the system, MCU starts to periodically detect ignition signal.  
Note that only MCU is working at this moment and the overall power consumption is less than 2 mW.
2. Ignition signal is active (both 12VDC and 24VDC ignition signals are accepted).
3. MCU starts to count a pre-defined power-on delay.
4. Once power-on delay expired, MCU turns on necessary standby power for the system (3.3VSB & 5VSB).
5. A PWRBTN# pulse is then issued to turn on the system (equivalent to one pressing the power button on the front panel).
6. The system is booting and becomes operational.
7. After a period of time, the ignition signal becomes inactive.
8. MCU starts to count a pre-defined power-off delay.
9. Once power-off delay expired, another PWRBTN# pulse is issued to perform a soft-off for the system (ex. a normal shutdown process for Windows system).
10. The system is completely shut down.
11. As MCU detects system is off, it turns off the standby power for the system, and operates in low power mode again (< 2mW power consumption).

### 3.6.2 Additional Features of Ignition Power Control

In addition to the typical timing correlation, the ignition power control module offers additional features to provide additional reliability for in-vehicle applications.

- **Low battery detection**

The ignition power control module continuously monitors the voltage of DC input when the system is operational. If input voltage is less than 11V (for 12VDC input) or less than 22V (for 24VDC input) over a 60-second duration, it will shut down the system automatically.

- **Guarded power-on/ power-off delay duration**

If ignition signal goes inactive during the power-on delay duration, the ignition power control module will cancel the power-on delay process and go back to idle status. Likewise if ignition signal goes active during the power-off delay duration, the ignition power control module will cancel the power-off delay process and keep the system running.

- **System hard-off**

In some cases, system may fail to shutdown via a soft-off operation due to system/ application halts. The ignition power control module offers a mechanism called “hard-off” to handle this unexpected condition. By detecting the system status, it can determine whether the system is shutting down normally. If not, the ignition power control module will force cut-off the system power 10 minutes after the power-off delay duration.

- **Smart off-delay**

The ignition power control module offers two modes (mode 6 & mode 7) which have very long power-off delay duration for applications require additional off-line time to process after the vehicle has stopped. In these two modes, the ignition power control module will automatically detect the system status during the power-off delay duration. If the system has shutdown (by the application software) prior to power-off delay expiring, it will cut off the system power immediately to prevent further battery consumption.

### 3.6.3 Wiring Ignition Signal

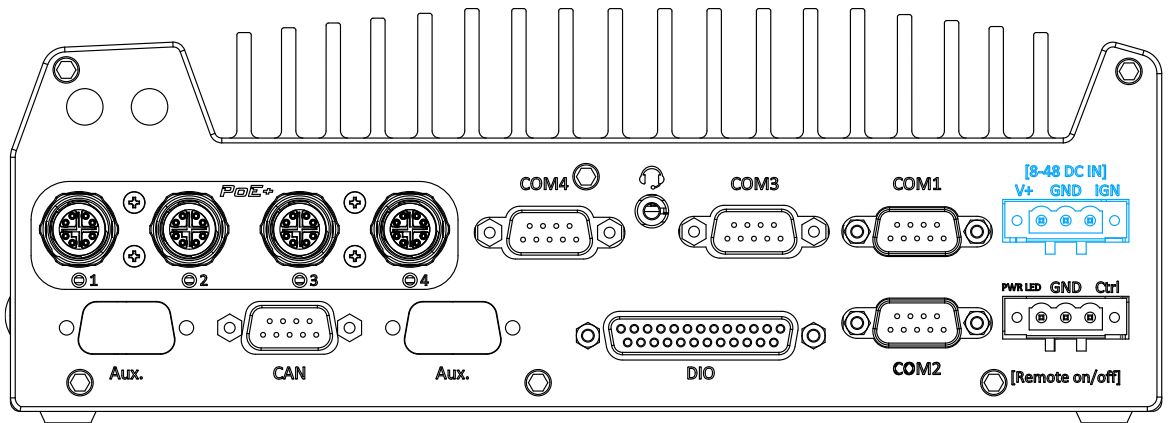

To have ignition power control for in-vehicle usage, you need to supply IGN signal to the system. The IGN input is located on the 3-pin pluggable terminal block (shared with DC power input). For in-vehicle ignition control wiring, please do the following:

1. Connect car Battery+ line (12V for sedan, 24V for bus/truck) to V+.
2. Connect car Battery- / GND line to GND.
3. Connect ACC line to IGN.

 **WARNING**

*Please make sure your DC power source and IGN signal share the same ground.*

*IGN input accepts 8~48VDC. Supply a voltage higher than 48VDC may damage the system.*

### 3.6.4 Configure your Windows system

When applying ignition power control to your system, please make sure you've configured your Windows system to initiate a shutdown process when pressing the power button. By default, Windows 10 goes to sleep (S3) mode when power button is pressed. As sleep (S3) is not a complete shutdown behavior, the ignition control function does not recognize the finish of a normal shut down process and thus users will encounter a system hard-off (power cut-off after 10 minutes). Please configure "When I press the power button" to "Shut down" in your Windows system settings.

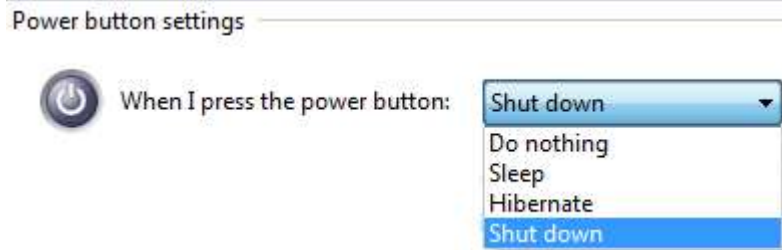

### 3.6.5 Operation Modes of Ignition Power Control

You can use the rotary switch to configure the operation mode. The system offers 16 (0~15) operation modes with different power-on/power-off delay configurations. The rotary switch can be located on the rear panel or the internal MezIO™ board, and to access it, please refer to the section “[Disassembling the System Enclosure](#)”.



**Nuvo-9100/ 9200VTC systems**



**Nuvo-9x04/ 9x08 VTC systems**



For Nuvo-9100/ 9200VTC systems, the ignition control rotary switch can be found on the MezIO™ once you disassemble the enclosure.

For Nuvo-9x04/ 9x08VTC systems, the ignition control rotary switch can be found on the side, or can be accessed through the punch-out opening on the panel.

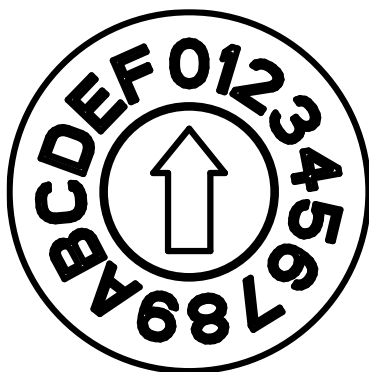

**Ignition rotary switch**

[The ignition control module is also BIOS-configurable.](#) When rotary switch is set to mode 15 (0xF), the ignition power control is set to executed according to parameters configured in BIOS setup menu, which allows richer combination of power-on/ power-off delay and more detailed control parameters.



- **Mode 0**

Mode 0 is the ATX mode without power-on and power-off delay. User can only use the power button on the front panel to turn on or turn off the system.

Mode	Power-on Delay	Power-off Delay	Hard-off Timeout
0	N/A	N/A	N/A

- **Mode 1**

Mode 1 is AT mode without power-on and power-off delay. The system automatically turns on when DC power is applied. A retry mechanism is designed to repeat the power-on cycle if the system fails to boot up.

Mode	Power-on Delay	Power-off Delay	Hard-off Timeout
1	N/A	N/A	N/A

- **Mode 2**

Mode 2 is designed to have a very minor power on/ off delay of 160ms for applications that requires the system to start up almost at the same as the rest of the equipment it is working in collaboration with.

Mode	Power-on Delay	Power-off Delay	Hard-off Timeout
2	160ms	160ms	10 minutes

- **Mode 3 ~ Mode 12**

Mode 3 ~ Mode 12 have various power-on delay and power-off delay. Each mode supports a hard-off timeout of 10 minutes.

Mode	Power-on Delay	Power-off Delay	Hard-off Timeout
3	10 seconds	10 seconds	10 minutes
4	10 seconds	1 minute	10 minutes
5	10 seconds	5 minutes	10 minutes
6	30 seconds	1 minute	10 minutes
7	30 seconds	5 minutes	10 minutes
8	30 seconds	10 minutes	10 minutes
9	3 minutes	1 minute	10 minutes
10 (A)	3 minutes	10 minutes	10 minutes
11 (B)	3 minutes	30 minutes	10 minutes
12 (C)	10 minutes	30 minutes	10 minutes

- **Mode 13 (D) / Mode 14 (E)**

Mode 13 and Mode 14 are ignition power control modes with very long power-off delay. Both modes support the feature of “smart off-delay”, which automatically detect system status during power-off delay duration and cut off system power if system is off in prior to power-off delay expired.

Mode	Power-on Delay	Power-off Delay	Hard-off Timeout
13 (D)	30 seconds	2 hours	10 minutes

14 (E)	3 minutes	2 hours	10 minutes
--------	-----------	---------	------------

- **Mode 15 (F)**

Mode 15 allows the user to configure the ignition control in the BIOS. Please refer to the following section for details.

### 3.6.6 BIOS Ignition Power Control [Mode 15 (F)]

The Mode 15 for ignition control allows ignition control settings to be configured in the BIOS.

**To set the ignition power control in the BIOS:**

1. Press **F2** when the system boots up to enter the BIOS setup utility.
2. Go to **[Power]** → **[Ignition Power Control]** and press **ENTER**.

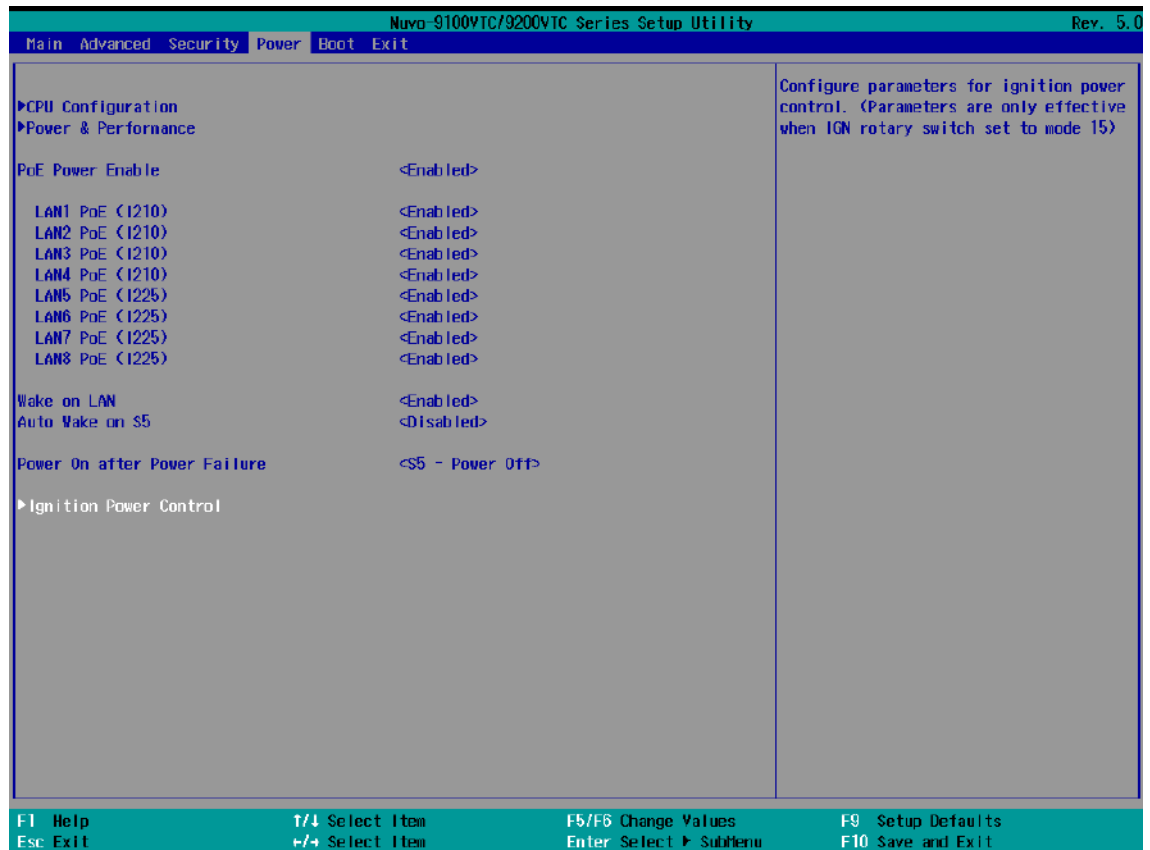

- Set **IGN Operation Mode** to “IGN” and press ENTER.



- If you wish to set the power on delay time from when you start-up the vehicle, highlight and select “Power On Delay”, select the timing according to your needs and press Enter.

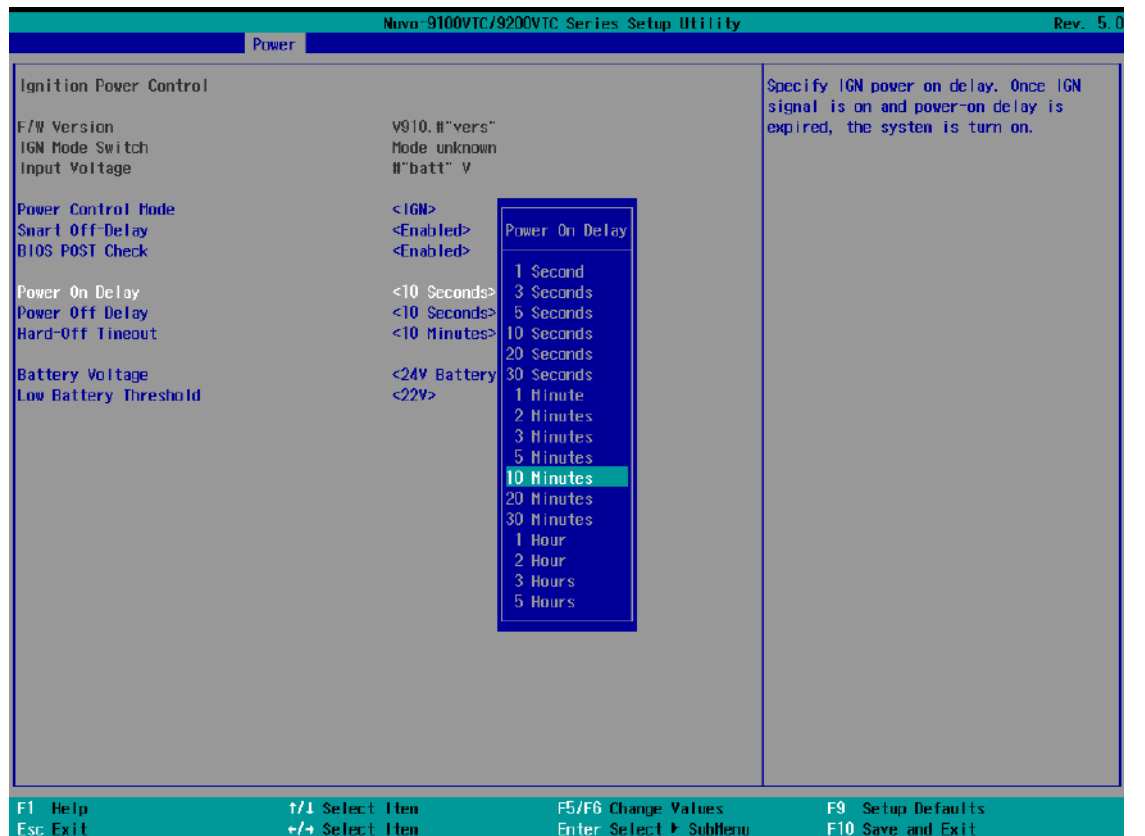

- If you wish to set the power off delay time from when you turn off the vehicle, highlight and select “Power Off Delay”, select the timing according to your needs and press Enter.

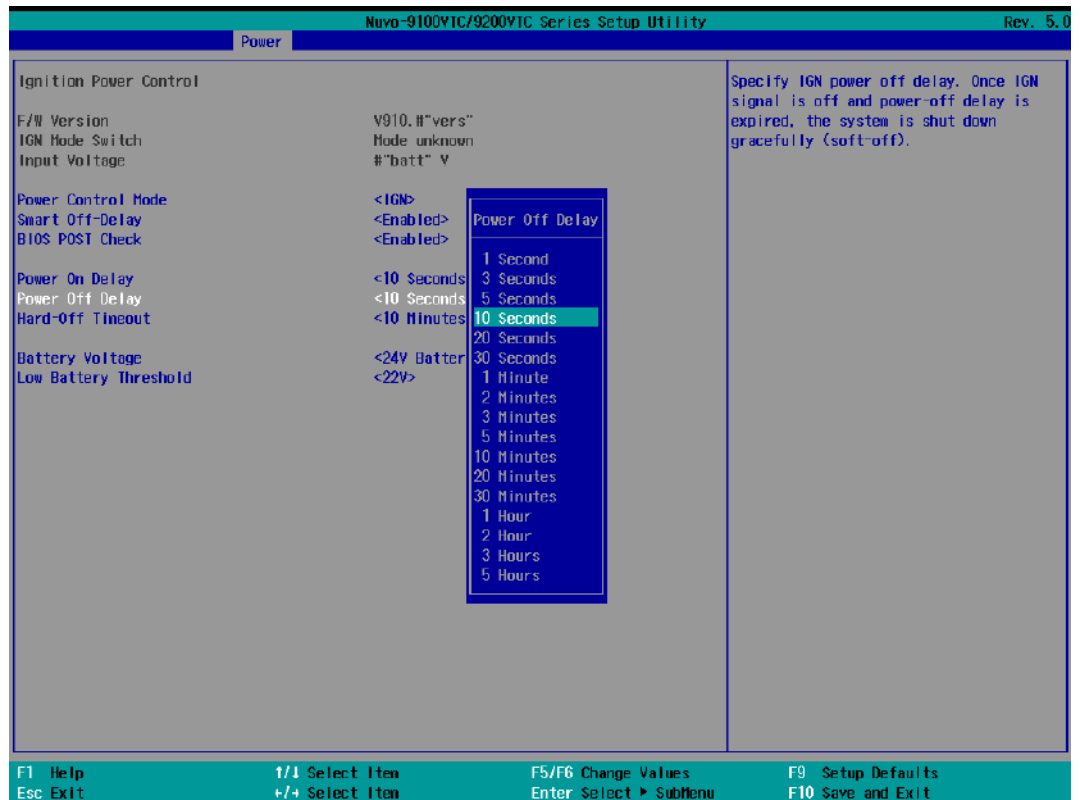

- If you wish to set the a hard power off timing, select “Hard-Off Timeout”, select the timing according to your needs and press Enter.

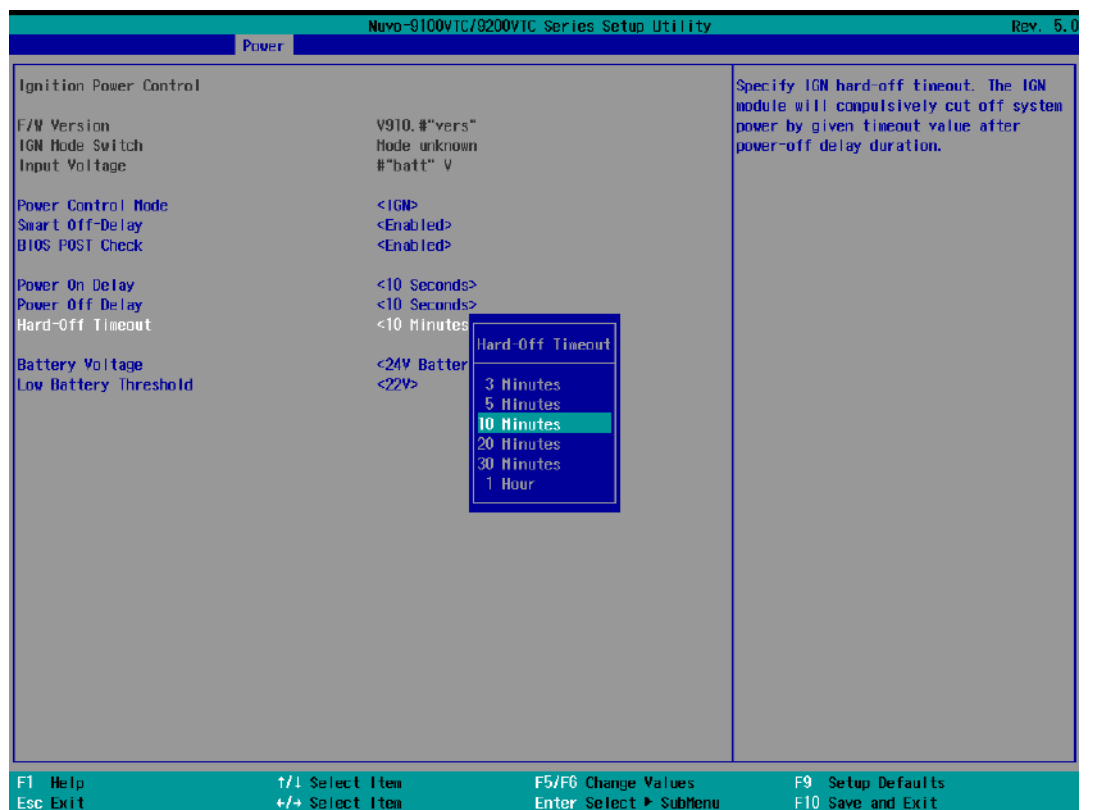



- For Battery voltage setting, you may choose between 12V (with a default low battery threshold of 11V, for normal passenger vehicles), or 24V (with a default low battery threshold of 22V, for trucks). Highlight an option and press Enter.

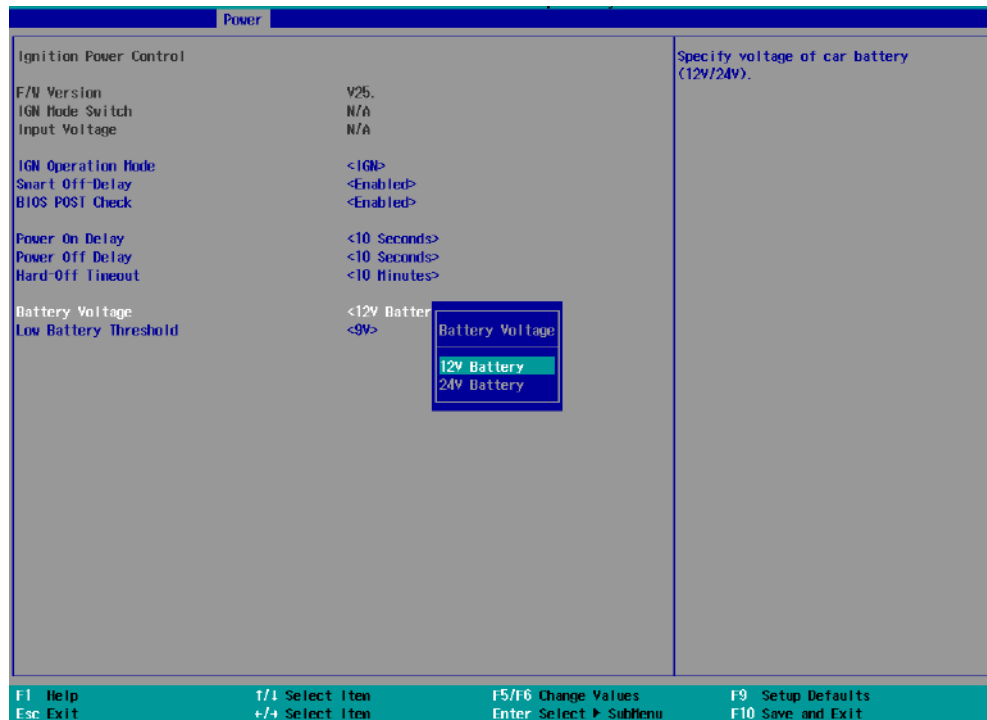

- To set the low battery threshold, highlight "Low Battery Threshold", select a setting, and press Enter.

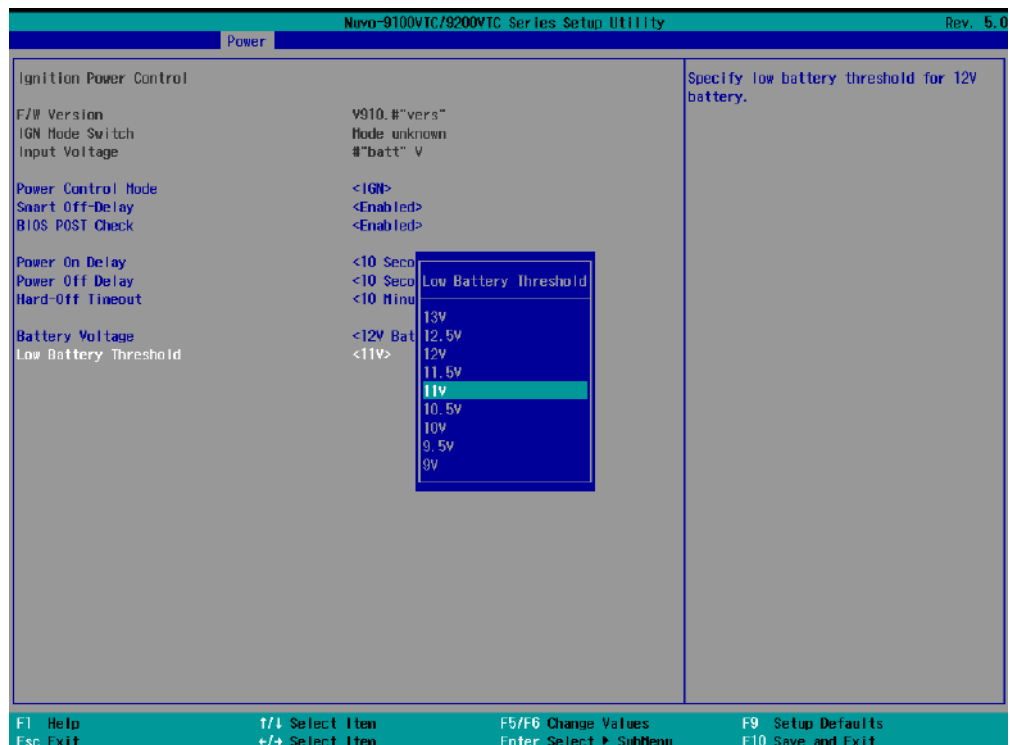

When you are done configuring the BIOS ignition control settings, press F10 to save changes and exit the BIOS.

# 4 System Configuration

## 4.1 BIOS Settings

The system is shipped with factory-default BIOS settings meticulously programmed for optimum performance and compatibility. In this section, we'll illustrate some of BIOS settings you may need to modify. Please always make sure you understand the effect of change before you proceed with any modification. If you are unsure of the function you are changing, it is recommended to change one setting at a time to see its effect(s).

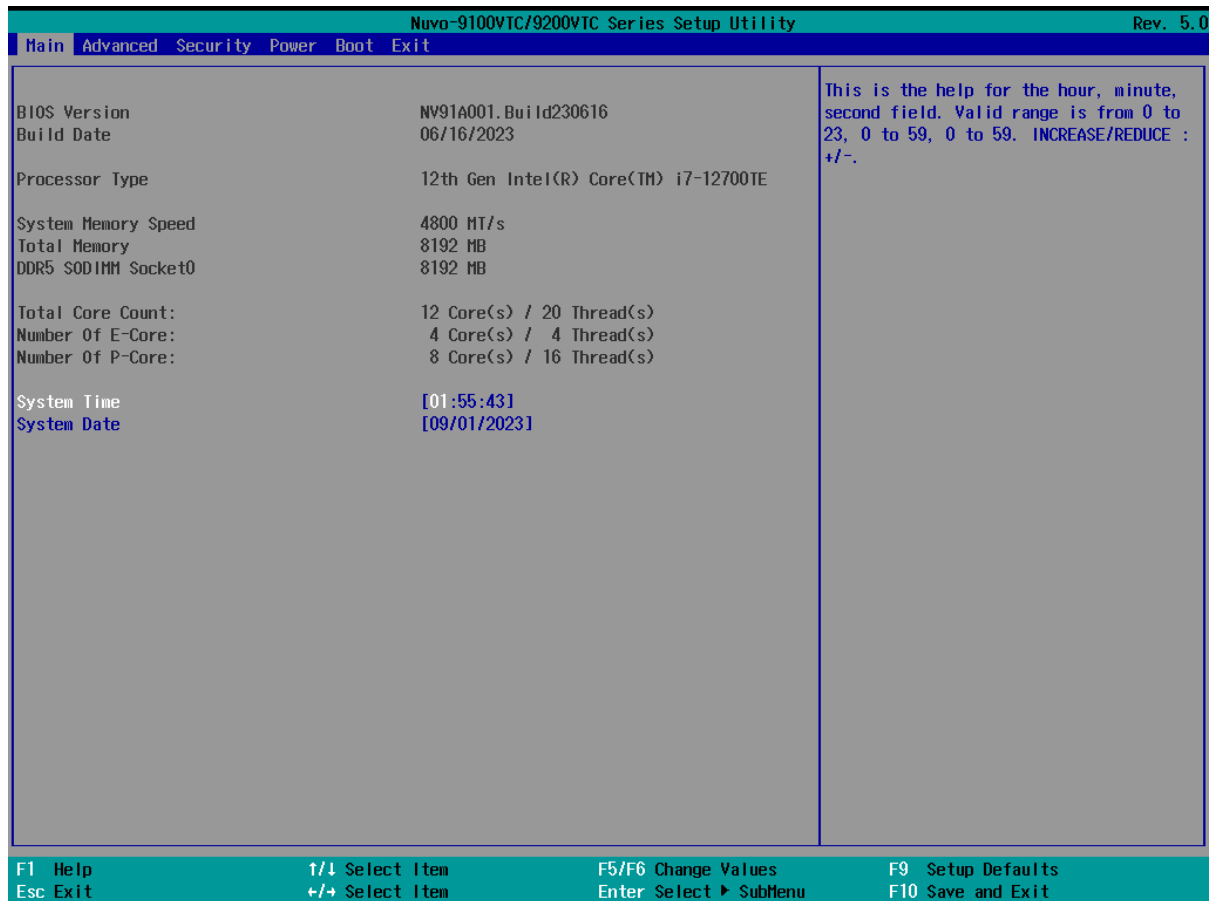

### NOTE

Not all BIOS settings will be discussed in this section. If a particular setting/ function you are after requires specific BIOS settings but is not discussed in this section, please contact Neousys Technical Support staff.

### 4.1.1 COM Port Configuration

The system's [COM1/COM2](#) ports support RS-232 (full-duplex), RS-422 (full-duplex) and RS-485 (half-duplex) mode. You can set the COM1 operating mode via BIOS settings. Another option in BIOS called “*Slew Rate*” defines how sharp the rising/falling edge is for the output signal of COM1. For long-distance RS-422/485 transmission, you may set the “*Slew Rate*” option as “High” to improve signal quality. For RS-422/485 communication, the “*RS-422/485 Termination*” option determines whether to enable/disable internal termination of RS-422/485 transceiver according to your wiring configuration (e.g. with or without external termination).

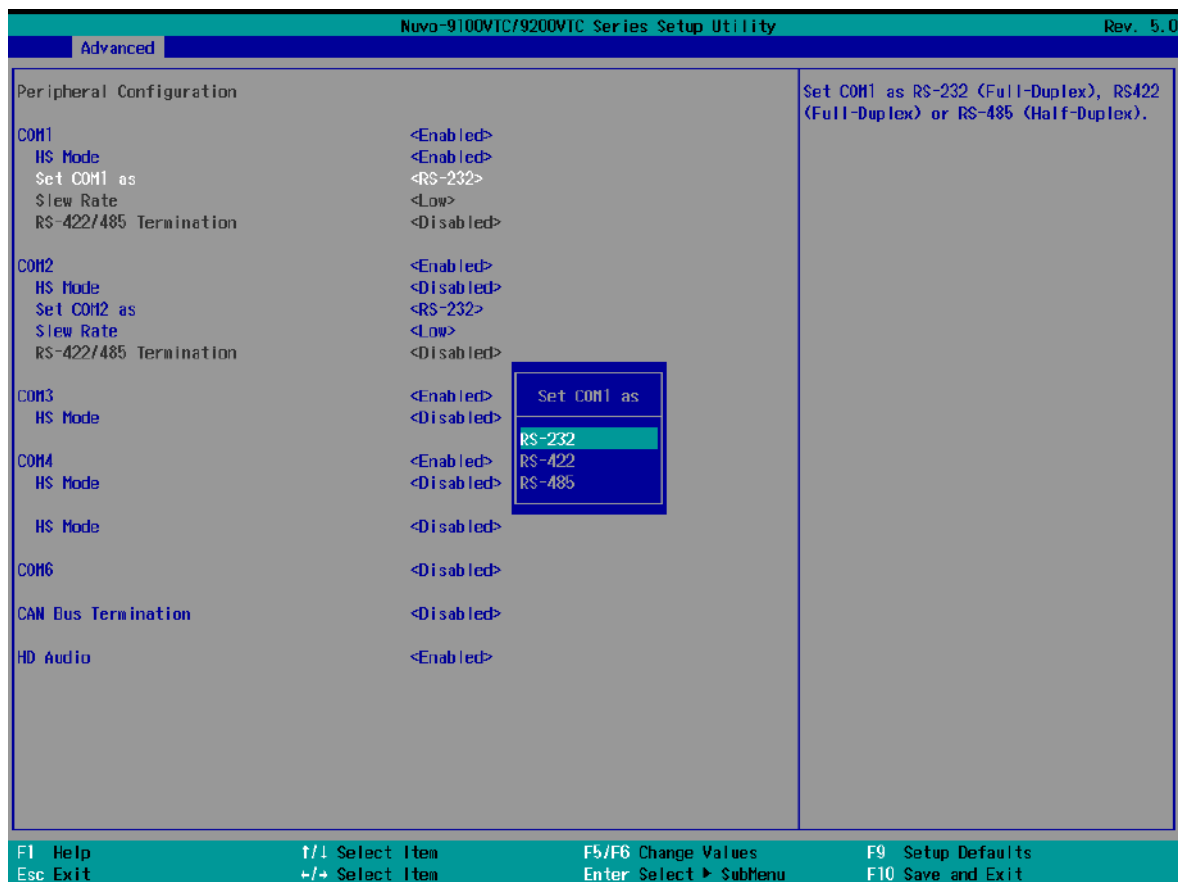

#### To set COM port operating mode:

1. Press **F2** when the system boots up to enter the BIOS setup utility.
2. Go to **[Advanced] > [Peripheral Configuration]**.
3. Set the **[Set COM1 Mode as]** option to the desired mode.
4. Once set, press **F10** to “Exit Saving Changes”.

### 4.1.2 COM Port High Speed Mode

The high speed mode of each COM port effectively allows for the port's baud rate generator to operate at 8x the speed with an effective baud rate of 921,600 bps (115,200 x 8). Please refer to the following instructions on how to enable the high speed mode for your COM port (COM1 used as an example).

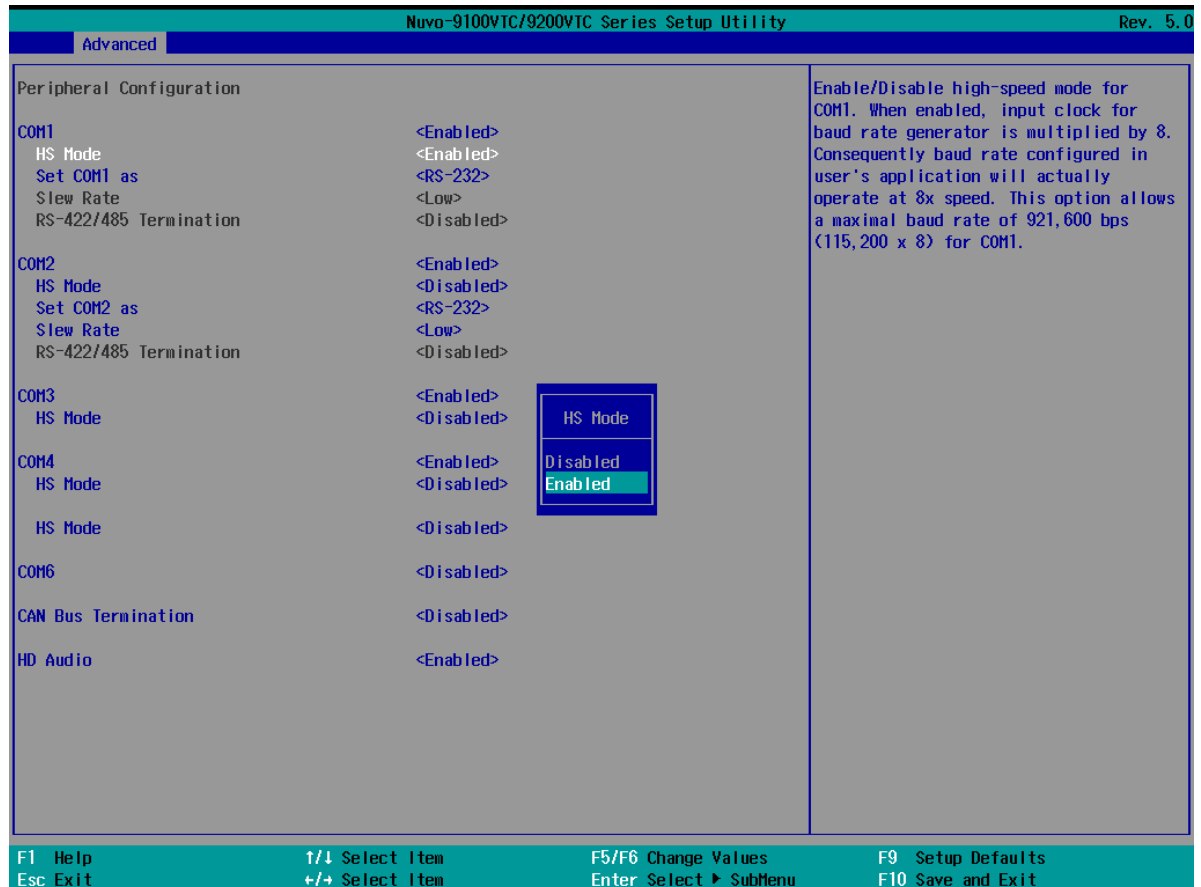

#### To set COM port high speed mode:

1. Press **F2** when the system boots up to enter the BIOS setup utility.
2. Go to **[Advanced] > [Peripheral Configuration]**.
3. Enable or set the **[Set COM1 Mode as]** option to the desired mode.
4. Highlight **[HS Mode]** and press ENTER to bring up options, highlight **[Enable]** and press ENTER.
5. Once set, press **F10** to "Exit Saving Changes".

### 4.1.3 Delay for PEG Initialization

This setting offers delay in milliseconds for PEG port initialization and PCI enumeration. By increasing the delay value, it may eliminate compatibility issue(s) with some PCIe add-on cards.

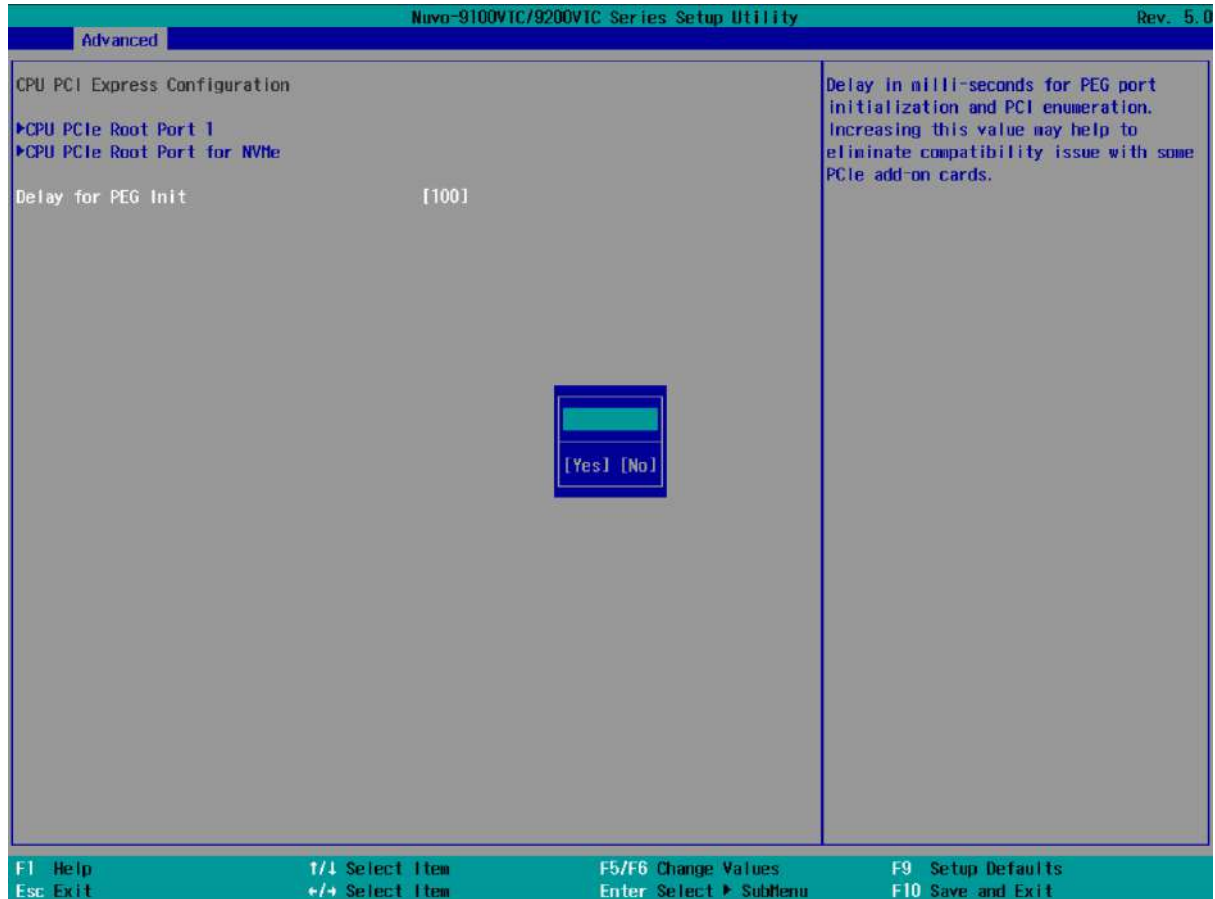

#### To set PEG delay in milliseconds:

1. When system boots up, press F2 to enter BIOS setup utility.
2. Go to **[Advanced] > [System Agent (SA) Configuration] > [CPU PCI Express Configuration] > [Delay for PEG Init]** and press ENTER.
3. A small window appears and you may enter a maximum delay value of up to 30,000ms.
4. When done, press F10 to "Exit Saving Changes"



#### 4.1.4 Volume Management Device (VMD)

Limited by the number hard drive the system can accommodate, the system supports RAID configurations in RAID 0 (striping) or RAID 1 (mirror) mode, you need to have at least two hard drives or SSDs installed. Users can select the configuration that best suit their needs with RAID 0 (striping) mode offering better hard drive read/ write performances while RAID 1 (mirror) offers better data security.



**WARNING**

*Please back up the hard drive data before you create or modify RAID volume(s) as the process may cause irreversible data deletion. When creating a RAID volume, it is also recommended to use hard drives from the same batch (same brand, model, capacity, rpm rate, etc.) to avoid performance or capacity allocation issues.*

1. When system boots up, press F2 to enter BIOS setup utility.
2. Go to **[Advanced]** > **[VMD setup menu]**, press ENTER.

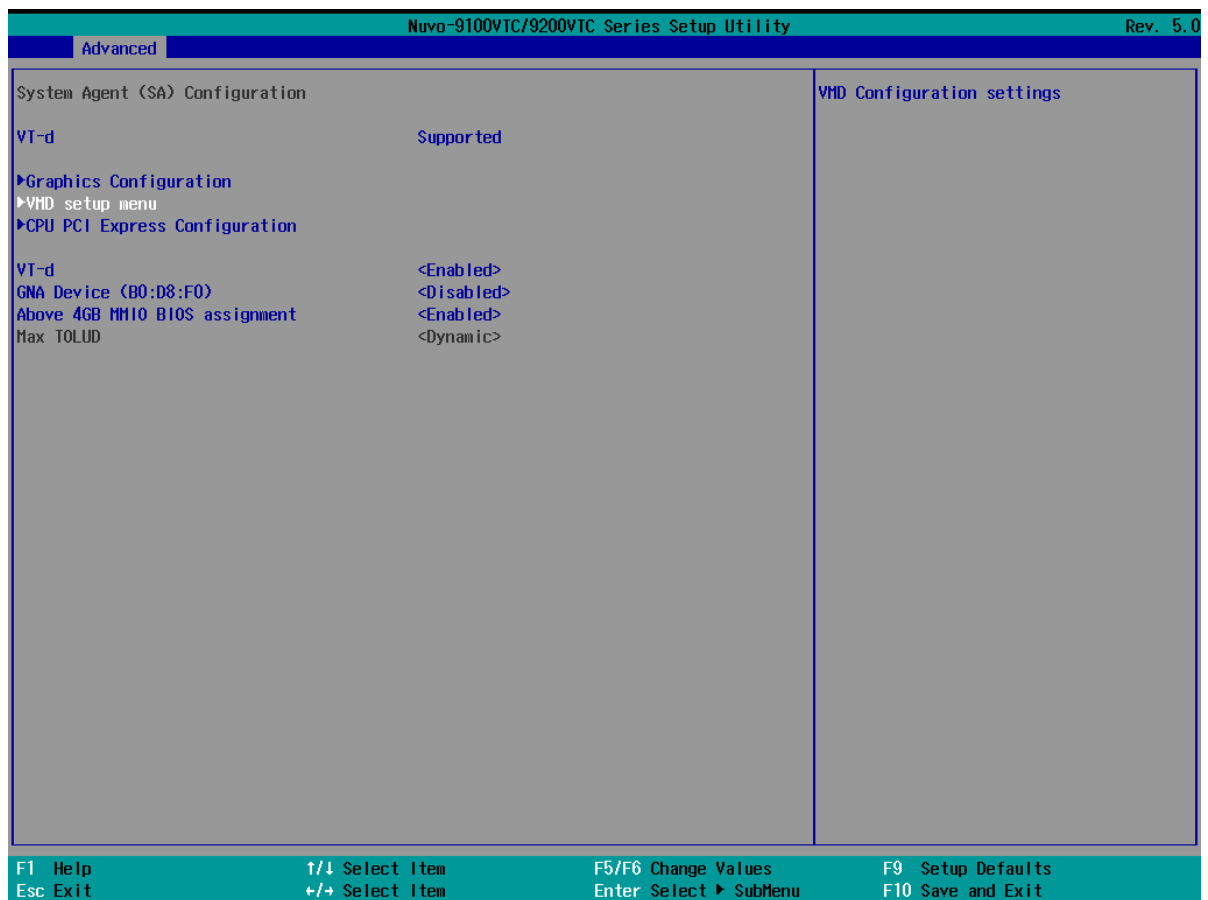

- Highlight **[Enable VMD controller]**, press ENTER to bring up Options, Enabled/ Disabled, select Enabled and press ENTER.

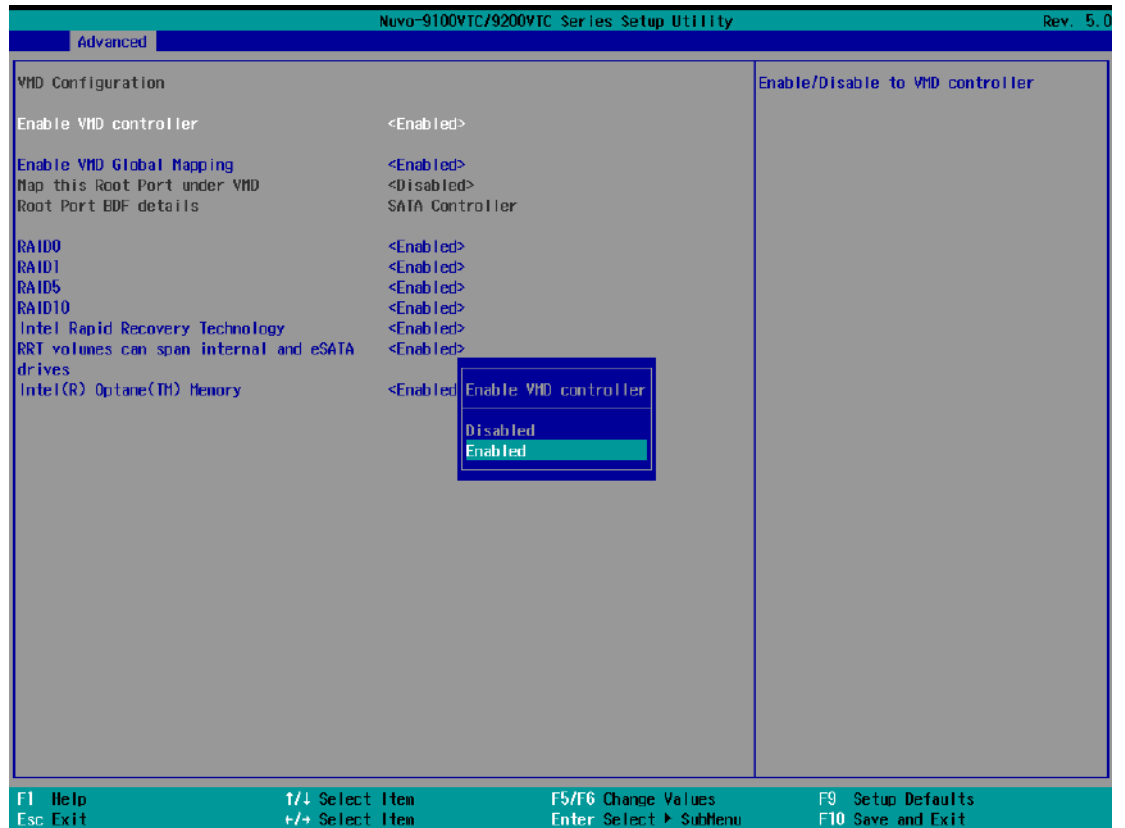

- Highlight **[RAID0]** or **[RAID1]**, press ENTER to bring up options, Enabled/ Disabled, select your choice and press ENTER again to confirm selection.

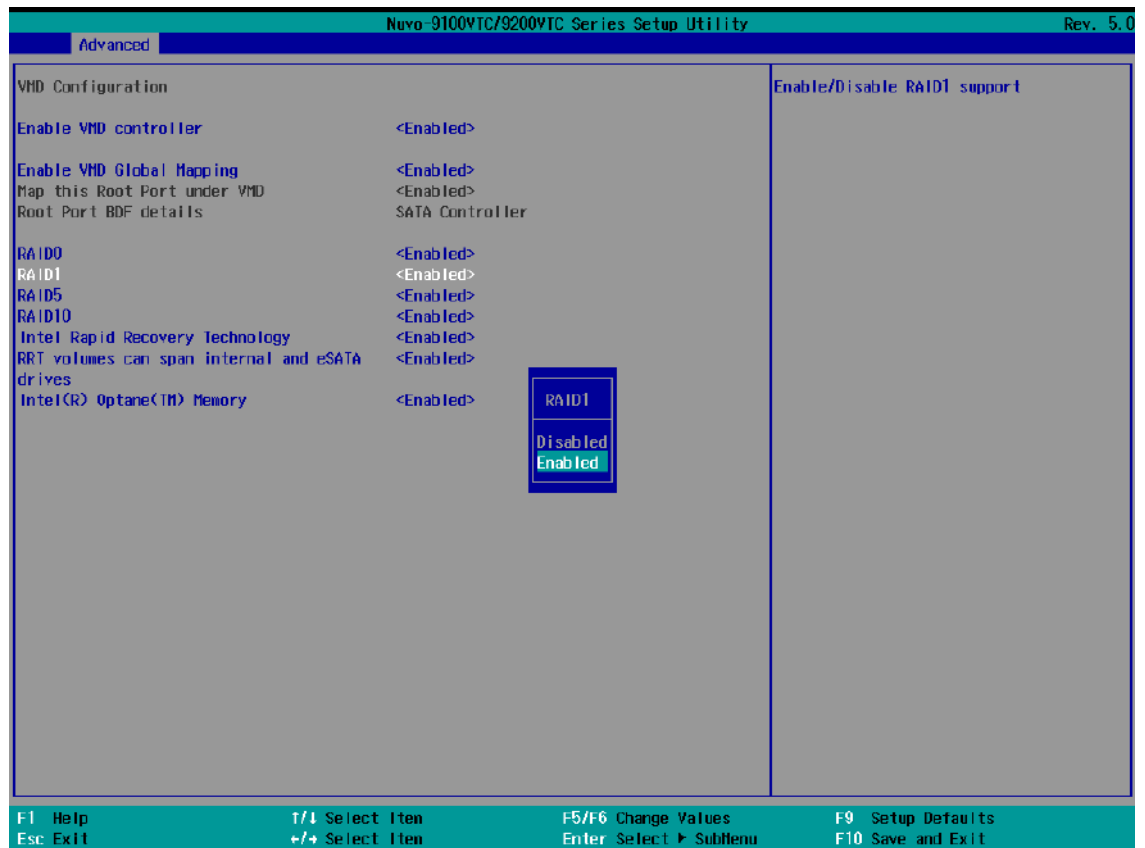

- Highlight your selection, press Enter and press F10 to "Exit Saving Changes".

### 4.1.5 TPM Availability

Trusted Platform Module (TPM) is a hardware-based cryptoprocessor to secure hardware by integrating cryptographic keys into devices. The system is designed with on-board TPM 2.0 module. As TPM 2.0 requires 64-bit Windows 10 with UEFI boot mode, it is enabled in BIOS by default.



#### To enable TPM availability:

1. When system boots up, press F2 to enter BIOS setup utility.
2. Go to **[Security] > [TPM Availability]**, press ENTER to bring up Options, Available/ Hidden.
3. Highlight your selection, press Enter and press F10 to “Exit Saving Changes”.

### 4.1.6 Power over Ethernet (PoE) Power Enable

Power over Ethernet (PoE) supplies electrical power and data on a standard CAT-5/CAT-6 Ethernet cable. Acting as a PoE PSE (Power Sourcing Equipment), compliant with IEEE 802.3at, each PoE port delivers up to 25W to a Powered Device (PD). The system has a total 100W power budget. The PoE power can be Enabled/ Disabled in the BIOS.

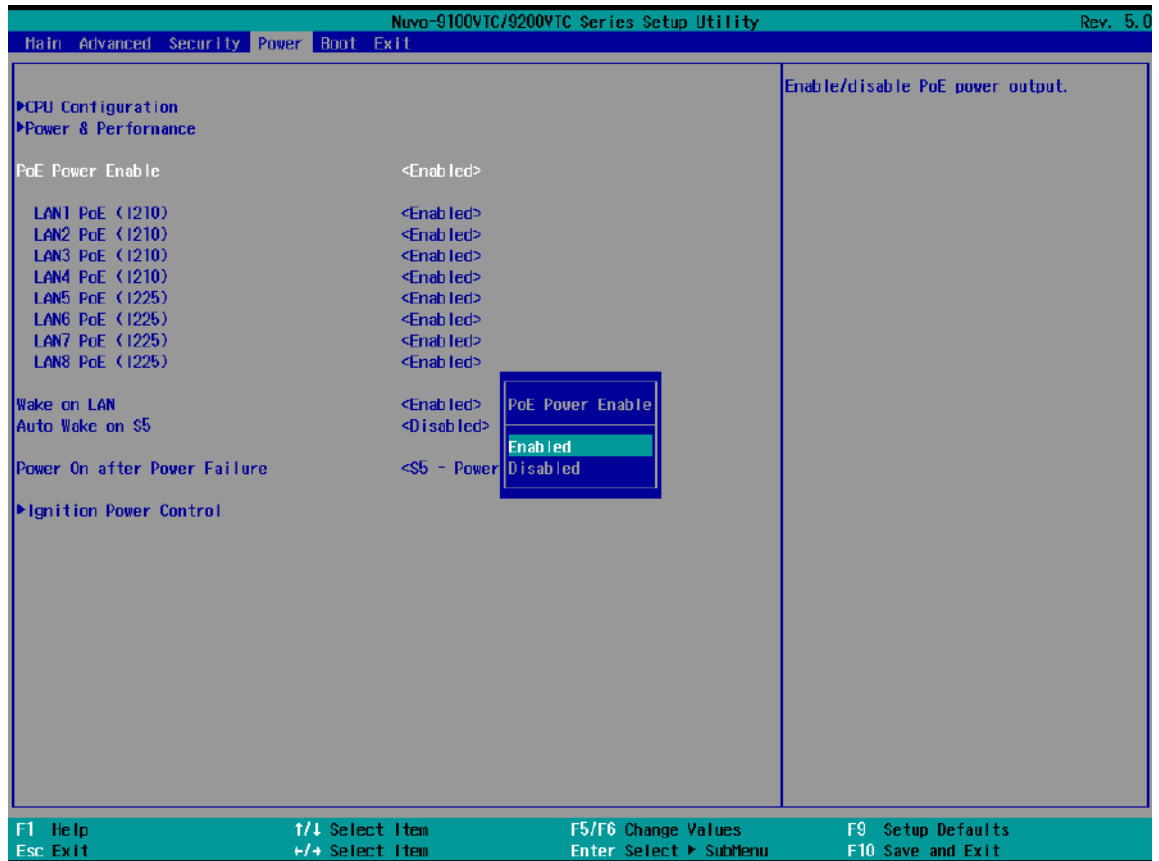

To enable/ disable “PoE Power Enable” option:

1. When system boots up, press F2 to enter BIOS setup utility.
2. Go to **[Power] > [PoE Power Enable]**.
3. Press ENTER to bring up setting options, scroll to the setting (Enabled/ Disabled) you desire and press ENTER to set.



- You can also enable/ disable each port, individually. Use the arrow key to highlight the port, press ENTER to bring up options (Enabled/ Disabled), press ENTER again to select the option.

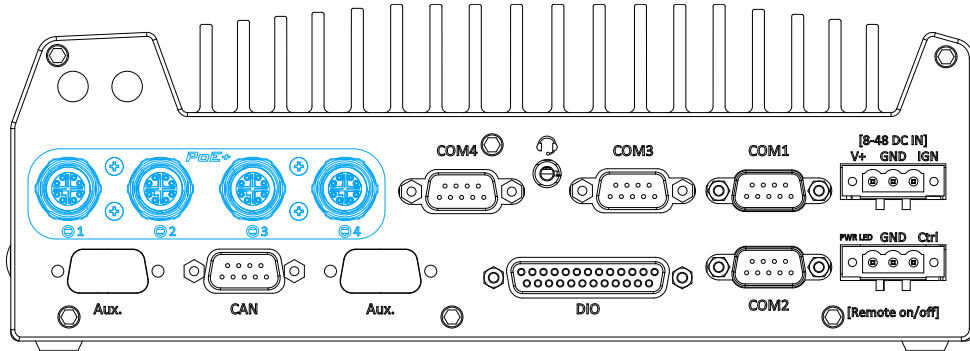

PoE ports 1 – 4 on rear panel

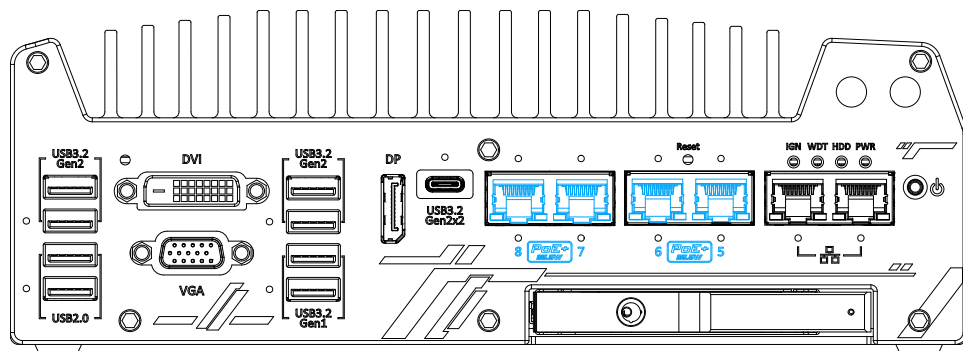

PoE ports 5 – 8 on front panel

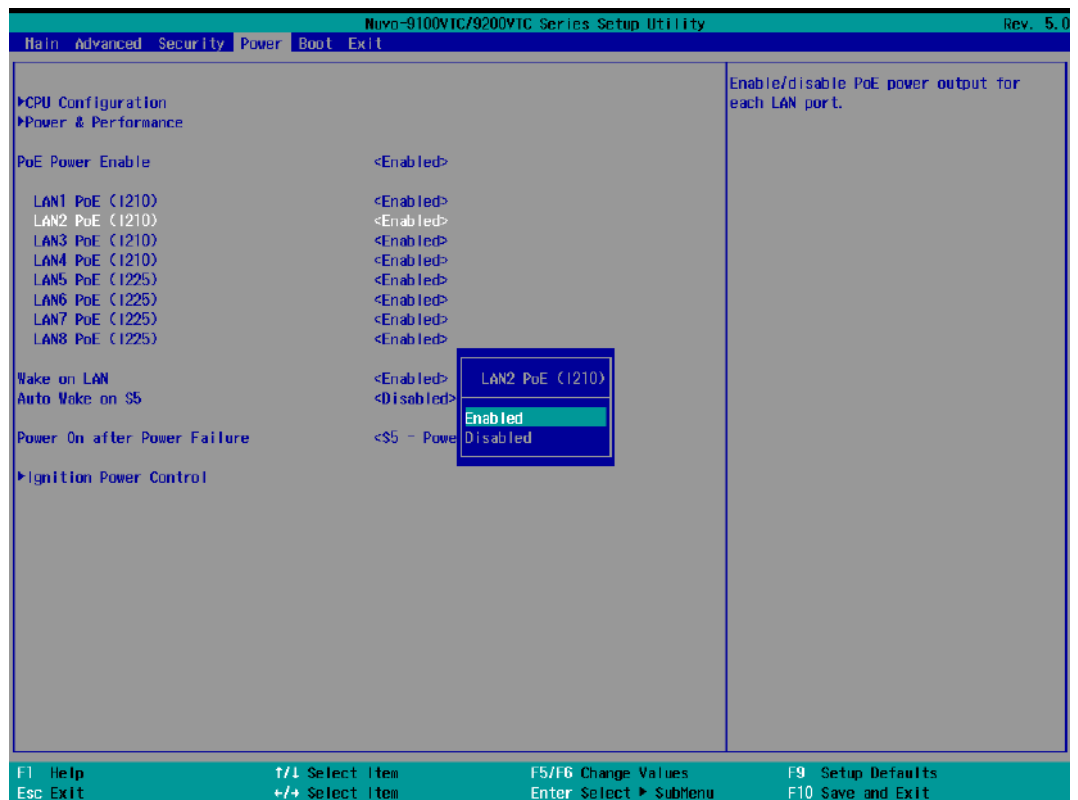

- Press F10 to “Exit Saving Changes”.

### 4.1.7 Auto Wake on S5

When the system is set to operate in S5 state, the user can specify a time to turn on the system, daily or monthly.

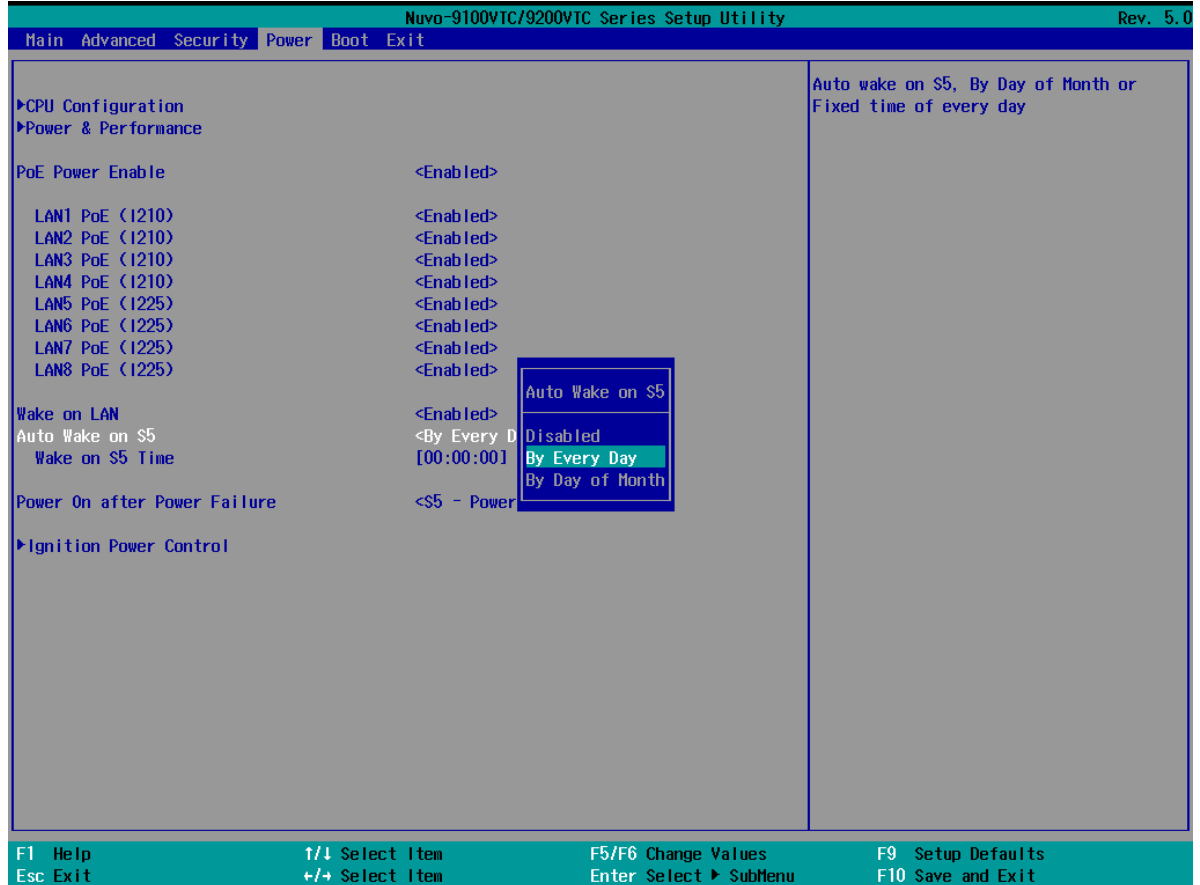

Value	Option	Description
Auto Wake on S5	Disabled	The system does not turn on when operating in state S5.
	By Every Day	The system turns on each day when operating in state S5. Specify the time of day.
	By Day of Month	The system turns on each month when operating in state S5. Specify the day and time.

Highlight your selection, press ENTER and press F10 to “Exit Saving Changes”.

### 4.1.8 Power On After Power Failure Option

This option defines the behavior of System series when DC power is supplied.

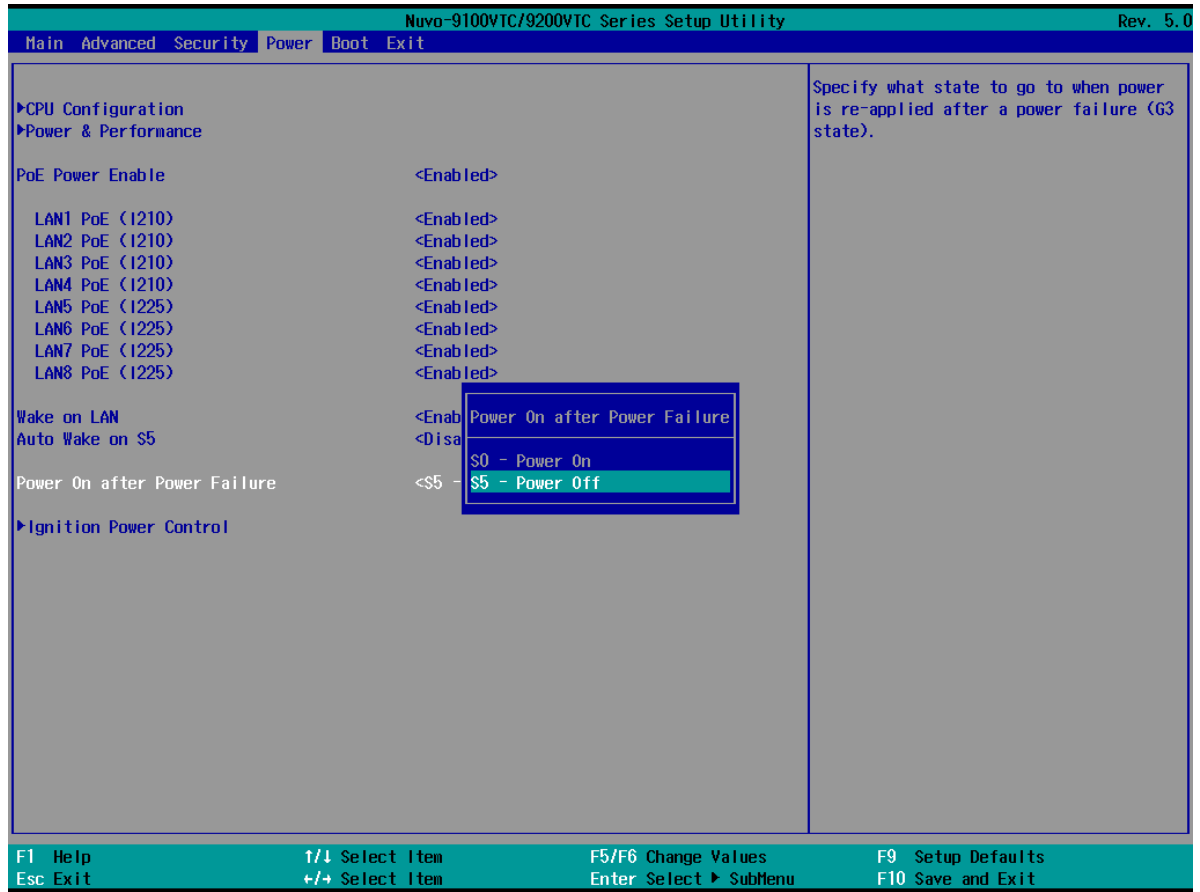

Value	Description
S0 – Power On	System is powered on when DC power is supplied.
S5 – Power Off	System is kept in off state when DC power is supplied.

To set “Power On after Power Failure” option:

1. When system boots up, press F2 to enter BIOS setup utility.
2. Go to **[Power] > [Power On after Power Failure]**.
3. Scroll down to highlight **[Power On after Power Failure]**, press ENTER to bring up setting options, S0 – Power On or S5 – Power Off, and press ENTER to select the setting.
4. Press F10 to “Exit Saving Changes”.

### 4.1.9 Power & Performance (CPU SKU Power Configuration)

The system supports Intel 13<sup>th</sup>/ 12<sup>th</sup> Gen LGA 1700 CPUs from 35W to 65W TDP. A unique feature, “**SKU Power Config**” is implemented in BIOS to allow users to specific user-defined SKU power limit. Although the system is designed to have best thermal performance with CPUs of 35W TDP, you can install a 65W CPU and limit its SKU power (to 35W) to obtain more computing power. This feature gives you the flexibility of CPU selection and great balance between computing power and operating temperature range.

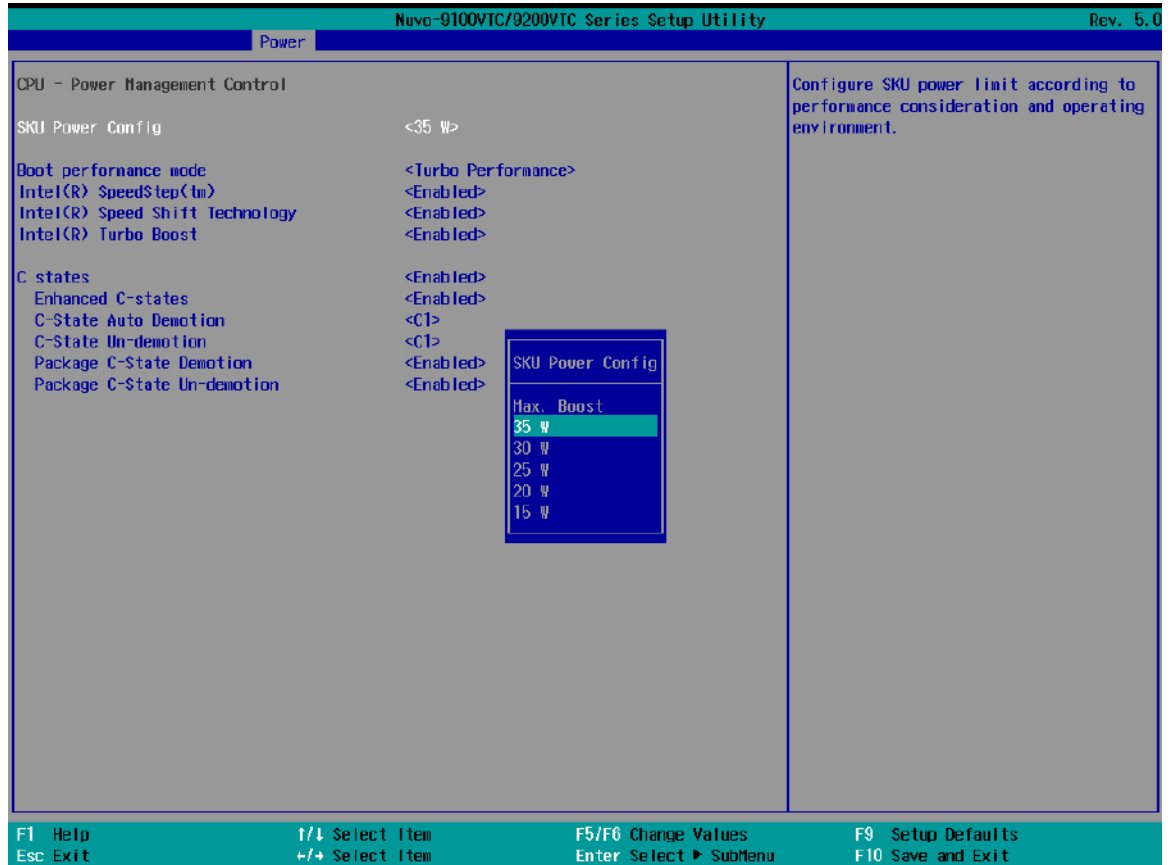

To configure the CPU SKU power limit:

1. When the system boots up, press F2 to enter BIOS setup utility.
2. Go to **[Power]** → **[Power & Performance]** → **[Power Management Control]**.
3. Select a proper value of SKU power limit for **[SKU Power Config]** option.
4. Press F10 to “Exit Saving Changes”.



**NOTE**

*The option "Max. Boost" unleashes the CPU's maximum performance with the highest power consumption. Make sure you're using a power supply with a rated power output four times that of the CPU TDP to ensure reliable system operations.*

### 4.1.10 Active Performance/ Efficient Cores



**NOTE**

*The default “Active Performance/ Efficient Cores” is recommended. Both the Performance/ Efficient cores are all enabled by default (if efficient cores are available).*

Depending on the CPU model, Intel 13<sup>th</sup>/ 12<sup>th</sup> Gen CPU may come in a hybrid configuration of “Performance” and “Efficient” cores. In the CPU Configuration setting, the BIOS allows the user to disable/ enable Performance/ Efficient cores.

**By disabling the Efficient-cores**, you may see an increase in operating frequencies in the Performance cores. The overall multi-core performance may degrade but if your application utilizes no more than four cores, it may benefit the overall performance.

**By disabling the Performance cores**, the system may consume less power and generate less heat at the cost of performance loss. Both the Performance/ Efficient cores are all enabled by default (if efficient cores are available).

The following screenshot is a demonstration of i7-12700 with 8 performance cores and 4 efficient cores.

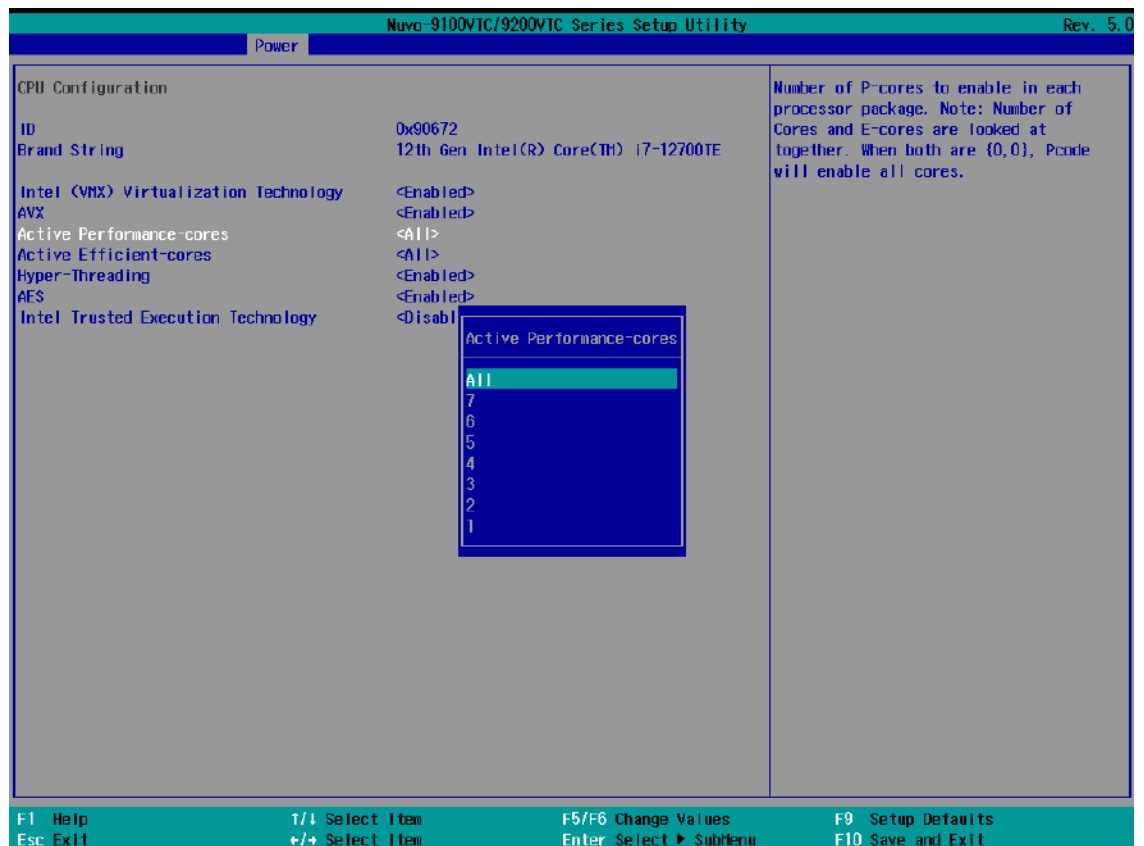

**Performance-cores**



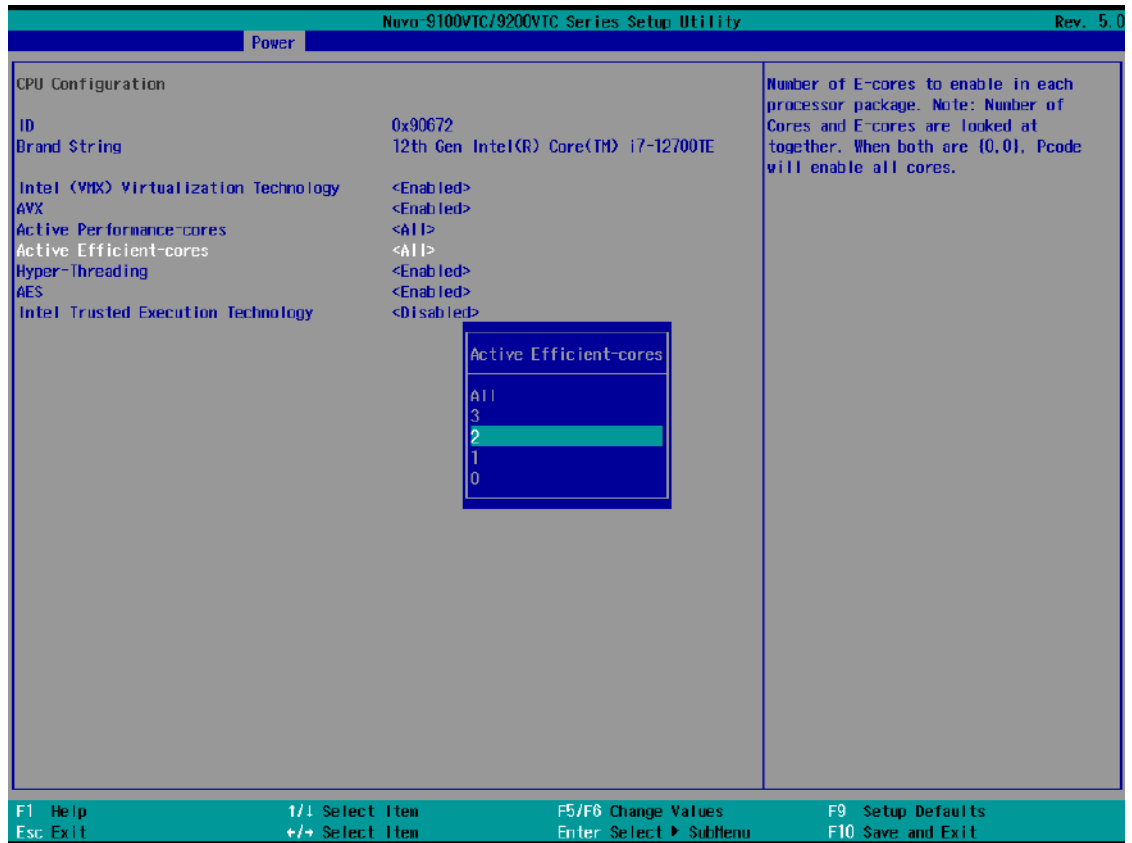

### Efficient-cores

To enable/ disable Performance/ Efficient cores:

1. When system boots up, press F2 to enter BIOS setup utility.
2. Go to **[Power] > [CPU Configuration]**.
3. Highlight Active Performance-cores or Active Efficient-cores and press ENTER, scroll to enable all or a selected number of cores to activate, press ENTER to set.
4. Press F10 to "Exit Saving Changes".

### 4.1.11 Wake on LAN Option

Wake-on-LAN (WOL) is a mechanism which allows you to turn on your System series via the Ethernet connection. To utilize Wake-on-LAN function, you have to enable this option first in BIOS settings. Please refer "[Powering On Using Wake-on-LAN](#)" to set up the system.

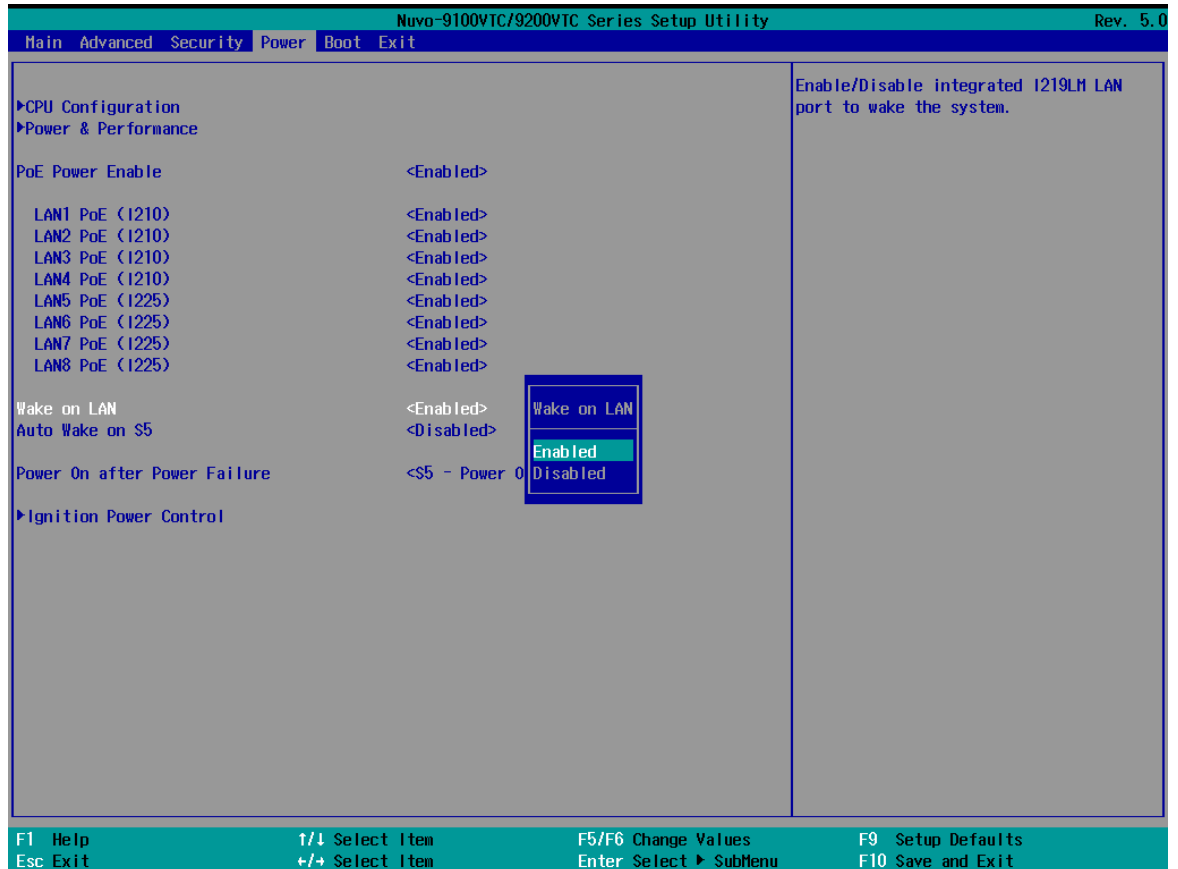

To enable/ disable “Wake on LAN” option:

1. When system boots up, press F2 to enter BIOS setup utility.
2. Go to **[Power] > [Wake on LAN]**.
3. Press ENTER to bring up setting options, scroll to the setting you desire and press Enter to set.
4. Press F10 to “Exit Saving Changes”.

### 4.1.12 Boot Menu

The Boot menu in BIOS allows you to specify the system’s boot characteristics by setting bootable device components (boot media) and method. Or, you may press F12 upon system start up and select a device you wish boot from.

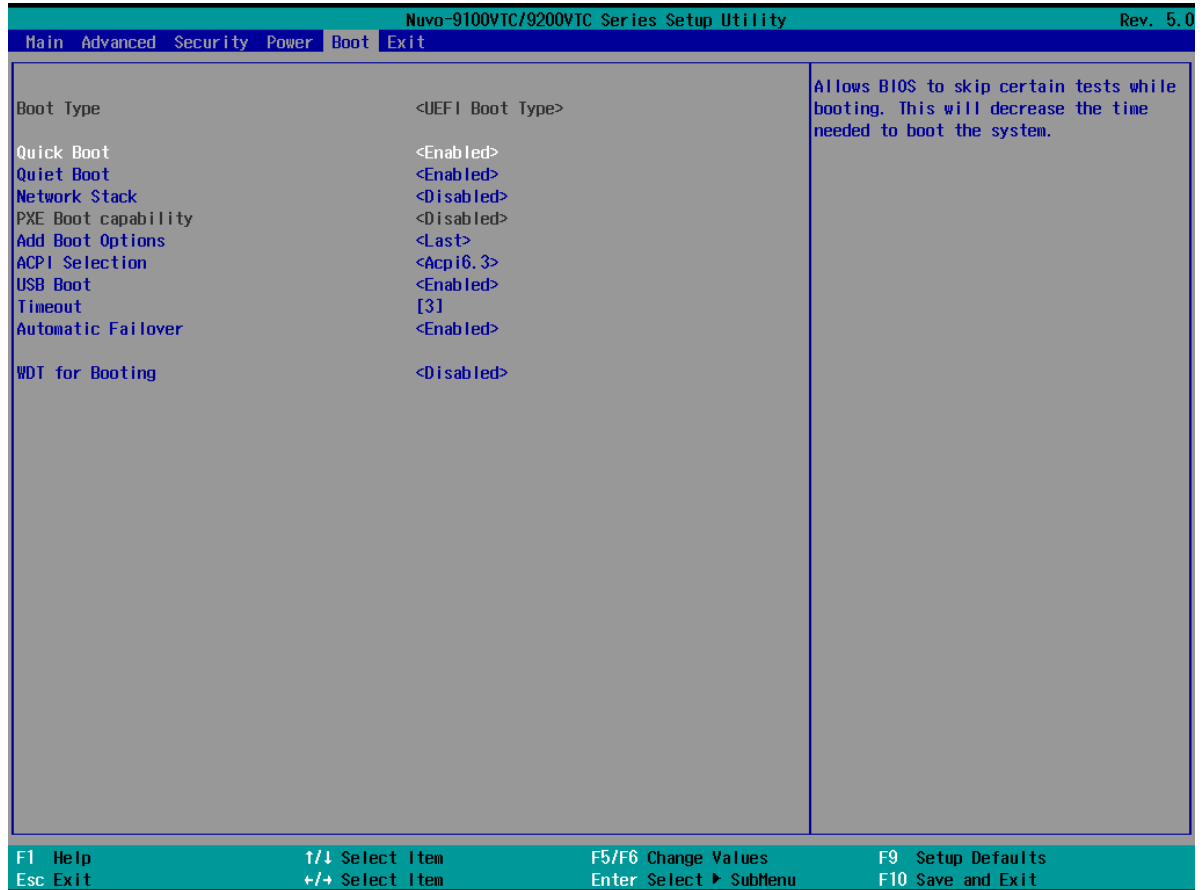

Value	Option	Description
<a href="#">Boot Type</a>	UEFI Boot Type	Only UEFI boot media listed are approved as boot media.
Quick Boot	Enabled	The system starts up faster because BIOS skips various hardware function tests
	Disabled	The system starts up slower because BIOS goes through various hardware functions tests
Quiet Boot	Enabled	During the boot up sequence, the system will display full screen logo and not show the motherboard POST messages.
	Disabled	During the boot up sequence, the system will display the motherboard POST messages.
Network Stack	Enabled	The system is available for network access using UEFI.

	Disabled	The system is not available for network access using UEFI.
PXE Boot capability	Disabled	Only UEFI Network Stack is supported: Preboot eXecution Environment (PXE) is not supported
	Enabled	By enabling the PXE boot, one can choose to boot via <b>I219 Only/ I225 Only</b> or <b>All NICs</b> .
Add Boot Options	First	Newly detected boot media are placed at the top of the boot order.
	Last	Newly detected boot media are placed at the bottom of the boot order.
ACPI Selection	1.0B/ 3.0/ 4.0/ 5.0/ 6.0	Advanced Configuration and Power Interface allows the operating system to control system power management
USB Boot	Enabled	Allow boot from bootable USB devices.
	Disabled	Does not allow boot from bootable USB devices
Timeout	1, 2, 3, etc (in seconds)	Boot delay time in seconds to give the user time to activate the hotkey to access the BIOS
Automatic Failover	Enabled	Automatically checks for the next bootable device when the set default device fails.
	Disabled	Will only boot from the designated device.
<a href="#">WDT for booting</a>	Disabled, 1, 3, 5, 10 (minutes)	WDT ensures a successful system boot by specifying a timeout value

### 4.1.13 Add Boot Options (Position New Boot Device)

The “Add Boot Options” allow you to determine whether a newly added device (eg. USB flash disk) is to boot as the first device to boot or the last in the boot sequence.

To set the newly-installed boot device as the first or last boot device:

1. Press **F2** when the system boots up to enter the BIOS setup utility.
2. Go to **[Boot] > [Add Boot Options]** menu.
3. Select **[First]** or **[Last]** for your newly-added boot device and press ENTER.

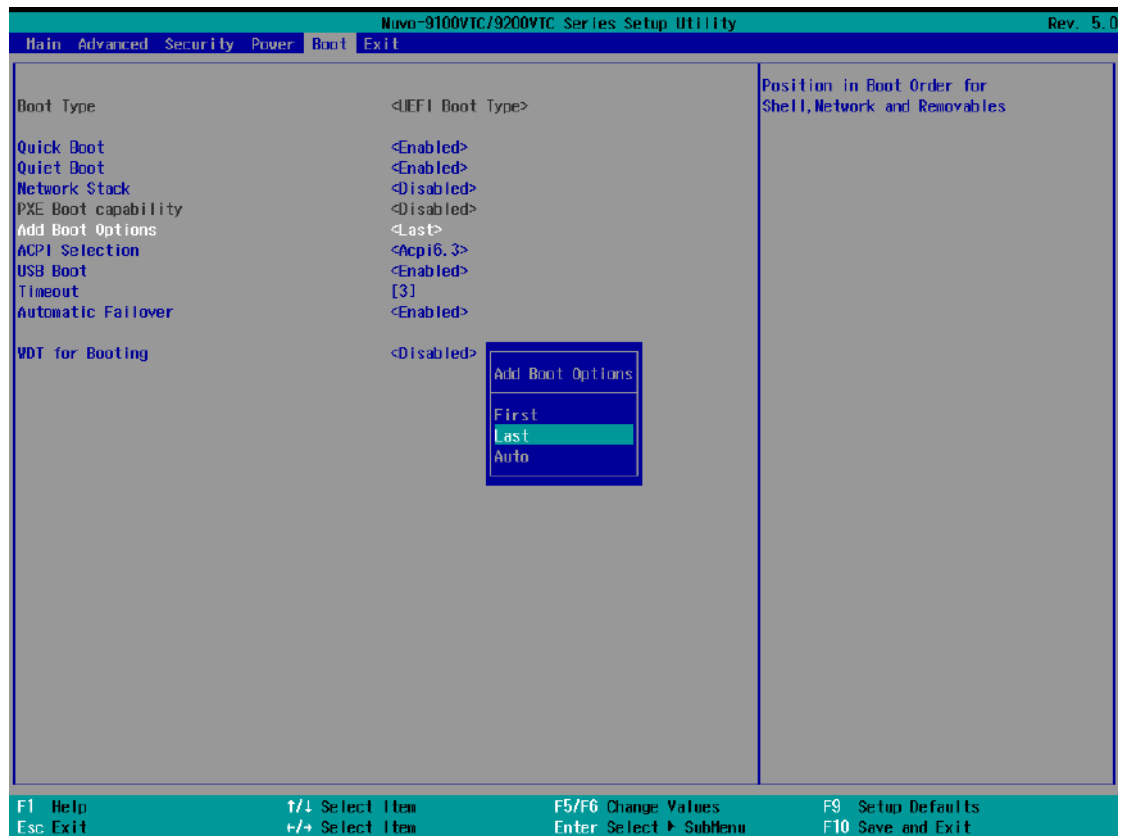

4. Once set, press **F10** to “Exit Saving Changes”.

#### 4.1.14 Watchdog Timer for Booting

The watchdog timer secures the boot process by means of a timer. Once the timer expires, a reset command is issued to initiate another booting process. There are two options in BIOS menu, “*Automatically after POST*” and “*Manually after Entering OS*”. When “*Automatically after POST*” is selected, the BIOS automatically stops the watchdog timer after POST (Power-On Self Test) OK. When “*Manually after Entering OS*” is selected, the user must stop the watchdog timer once booted into the OS. This guarantees the system can always boot into the OS, otherwise another booting process will be initiated. For information about programming watchdog timer, please refer to [Watchdog Timer & Isolated DIO](#).

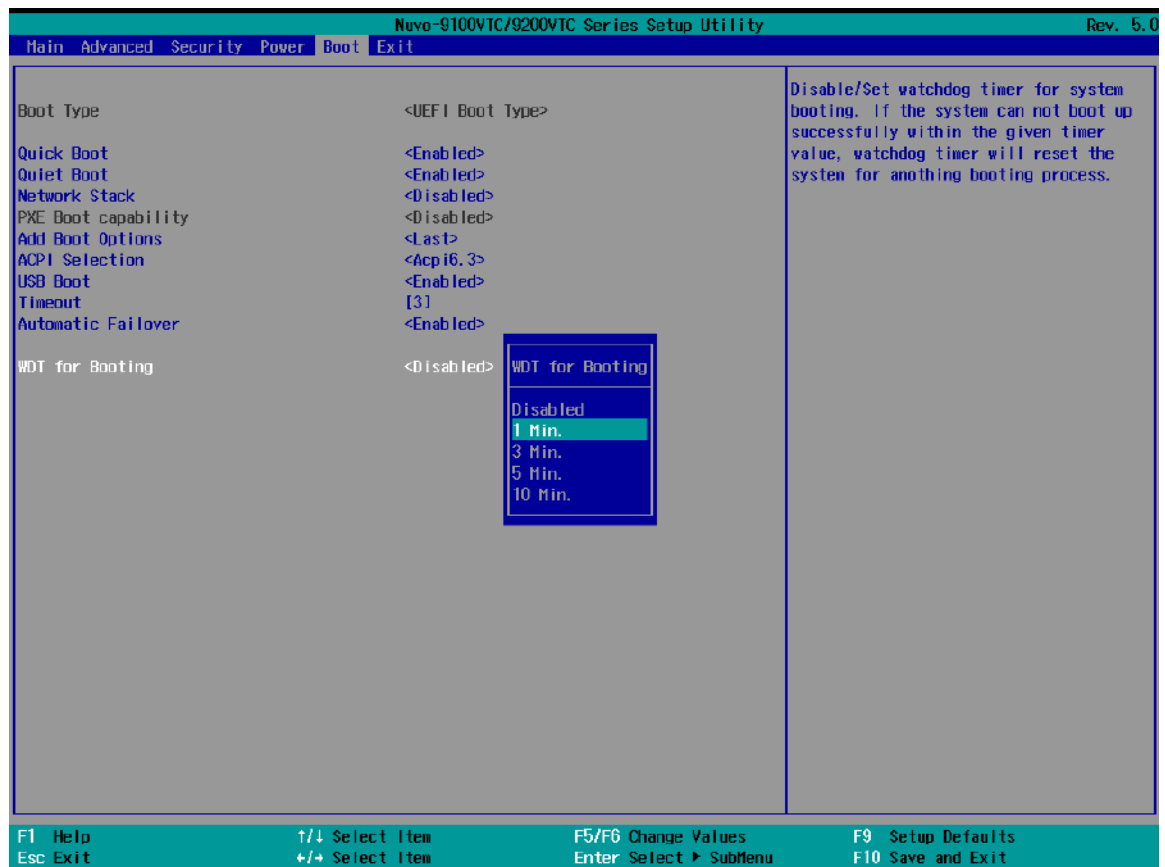

To set the watchdog timer for boot in BIOS:

1. When system boots up, press F2 to enter BIOS setup utility.
2. Go to **[Boot]** menu.
3. Disable or select timeout value for **[WDT for Booting]** option.
4. Once you give a timeout value, the **[WDT Stop Option]** option appears. You can select “*Automatically after POST*” or “*Manually after Entering OS*”.
5. Press F10 to “Exit Saving Changes”.



## 4.2 AMT Configuration

Intel® AMT (Active Management Technology) is a hardware-based technology for remotely managing target PCs via Ethernet connection. The system supports AMT function via its Ethernet port implemented with Intel I219-LM. Prior to using the AMT function to remotely control the system, you need to configure AMT password and network settings.

1. Connect Ethernet cable to I219-LM Ethernet port (indicated in blue).

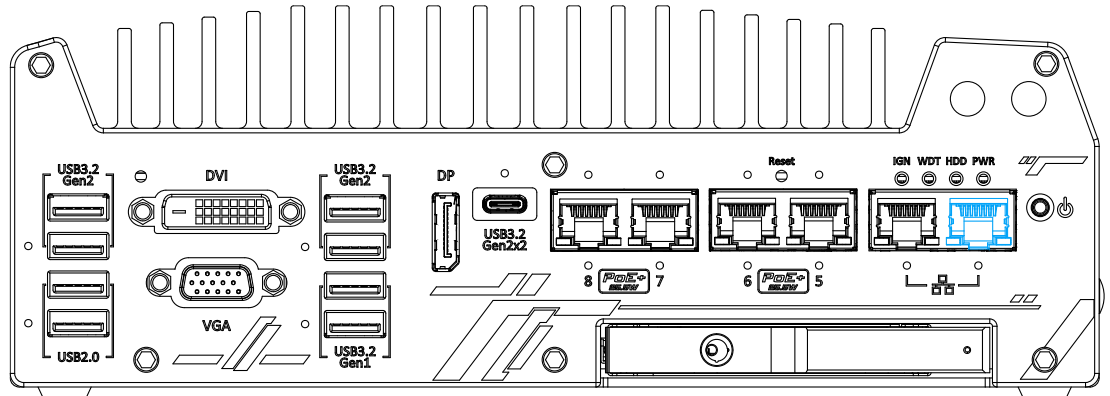

2. When the system boots up, press F10 to enter the “Front Page” menu, use the arrow key to highlight MEBx and press ENTER.

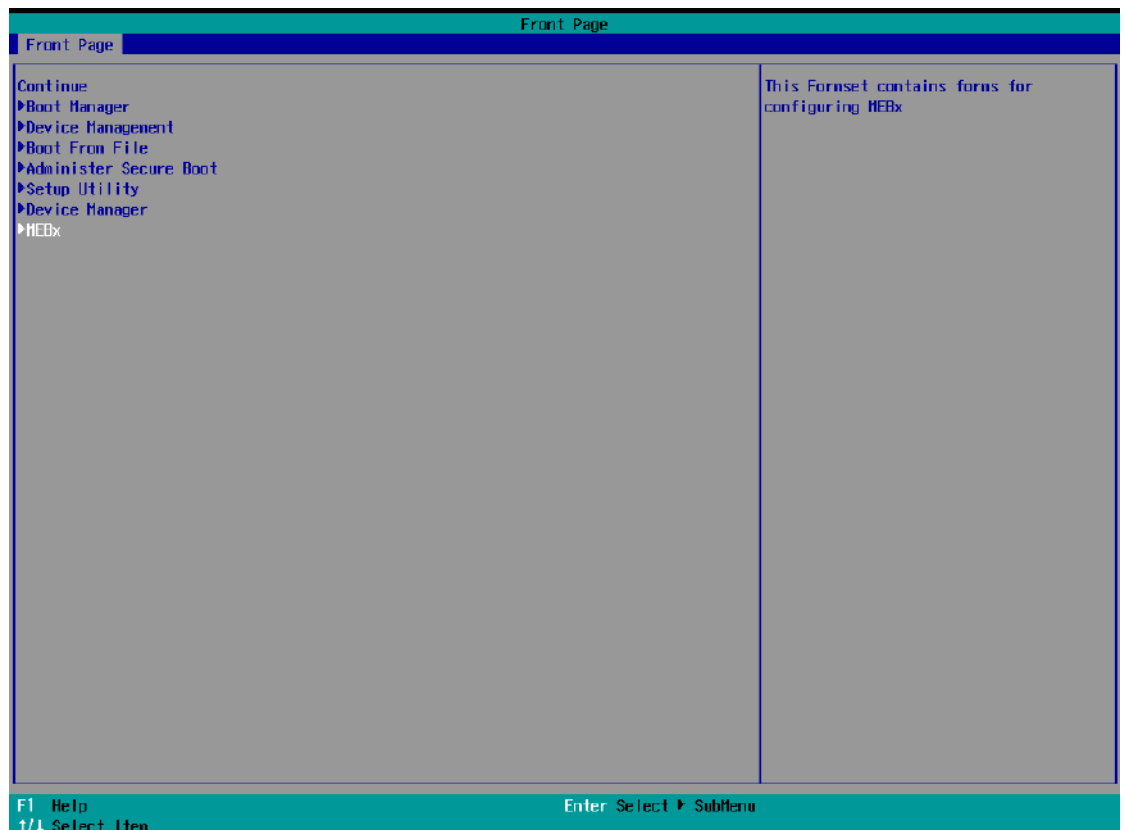

- When entering MEBx for the first time, it will ask for the default (old) password. Please type “admin” and press ENTER.



- The system will then request that you enter a new password. The new password must consist of at least one 7-bit ASCII non alpha-numeric character, above 32 (eg,!, @, \$) and 8 to 32 characters long. Note that under score “\_” is considered an alpha-numeric character.



- After typing your new password, it will bring you to the MEBx settings page. For more MEBx configuration details, please refer to [Intel® MEBX User Guide](#).



## 4.3 RAID Configuration

To set up a RAID 0 or 1 volume, you need to have at least two hard drives or SSDs installed. The system supports RAID configurations in RAID 0 (striping) or RAID 1 (mirror) mode. Users can select the configuration that best suit their needs with RAID 0 (striping) mode offering better hard drive read/ write performances while RAID 1 (mirror) offers better data security.



### WARNING

*Please back up the hard drive data before you create or modify RAID volume(s) as the process may cause irreversible data deletion. When creating a RAID volume, it is also recommended to use hard drives from the same batch (same brand, model, capacity, rpm rate, etc.) to avoid performance or capacity allocation issues.*

### 4.3.1 Enabling Volume Management Device (VMD) for RAID Volume Setup

1. When system boots up, press F2 to enter BIOS setup utility.
2. Go to **[Advanced] > [System Agent (SA) Configuration] > [VMD setup menu]**, and press ENTER.

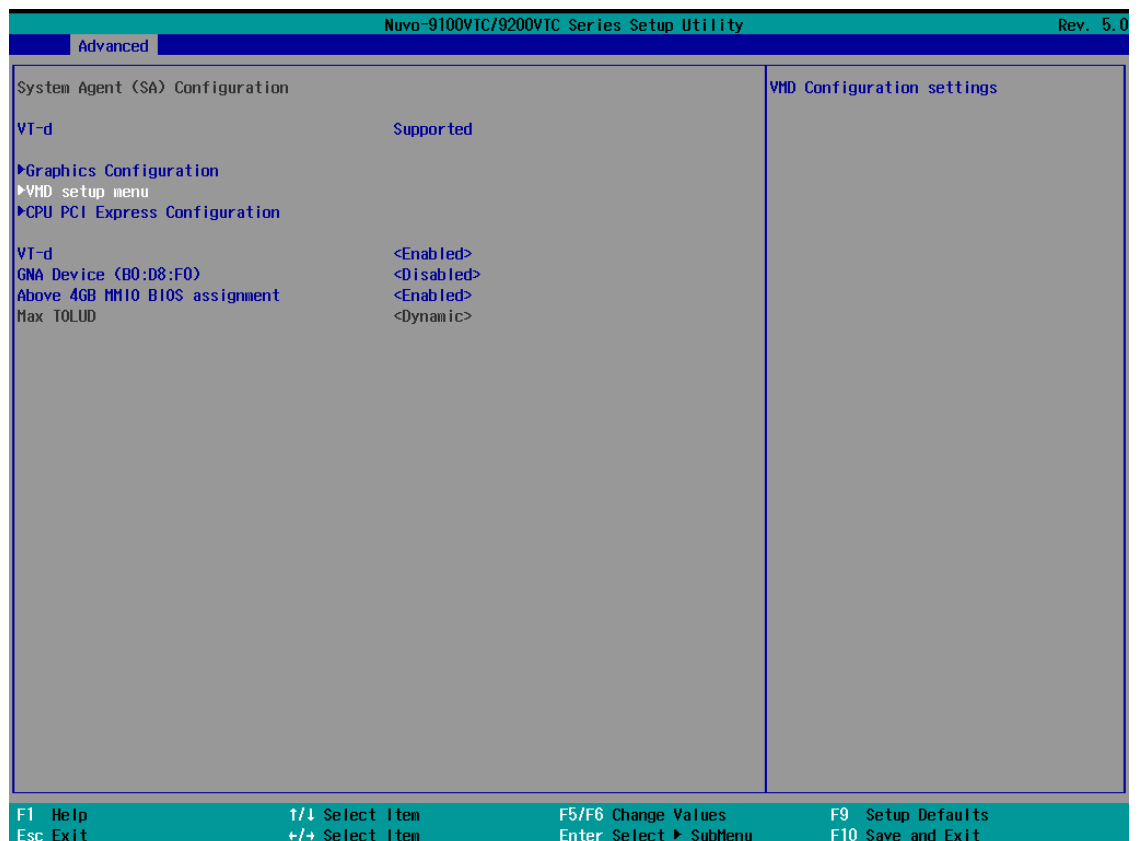

3. Select **[Enable VMD controller]** and press ENTER, highlight **[Enabled]** and press ENTER.

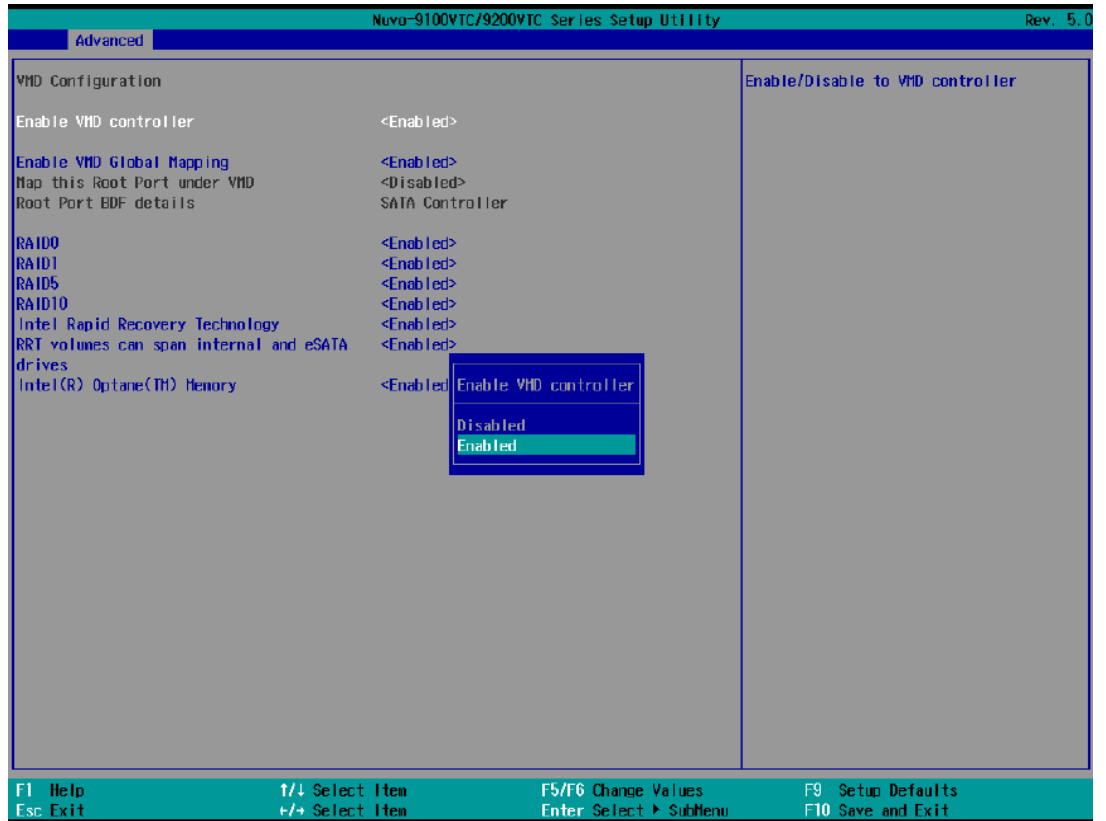

4. Press F10 to “Exit Saving Changes” and reboot the system.
5. When the system reboots, press **[F3]** to enter the Device Manager configuration utility.

### 4.3.2 RAID Volume Setup

- Once you've press F3 upon system boot up and you are in the Device Manager configuration utility, select **[Intel® Rapid Storage Technology]** and press ENTER.

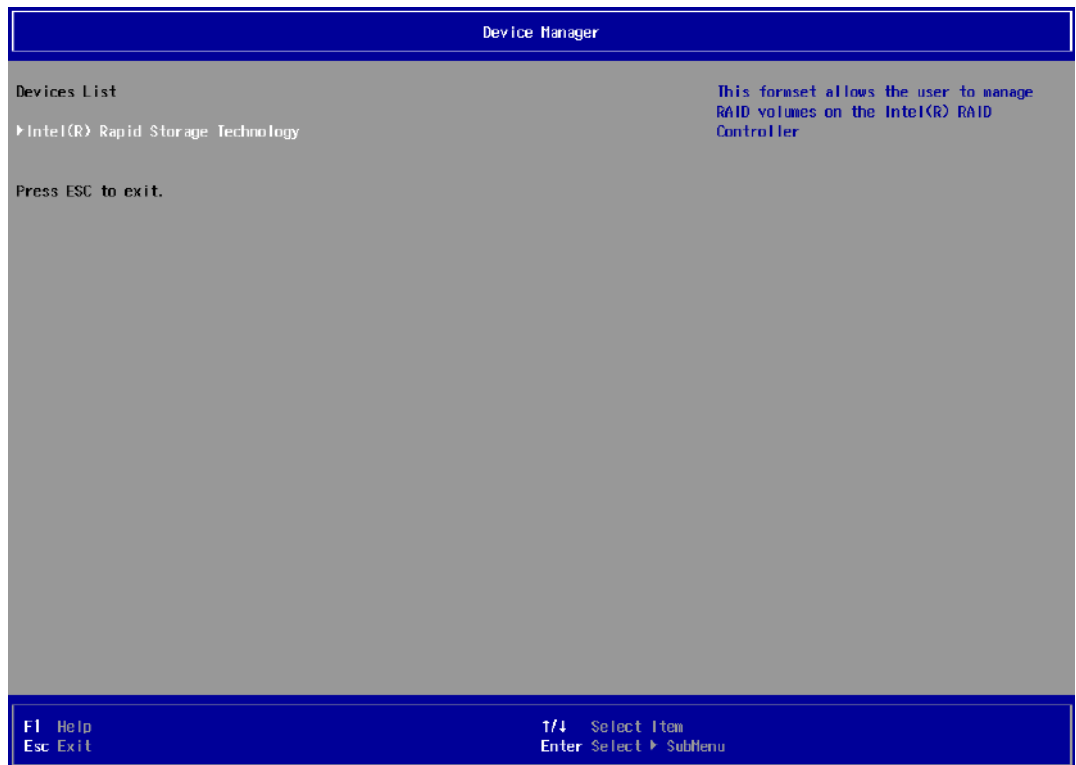

- The following screen shows Non-RAID physical disks and the option **“Create RAID Volume”**. Highlight **“Create RAID Volume”** and press ENTER to begin creating your RAID volume.

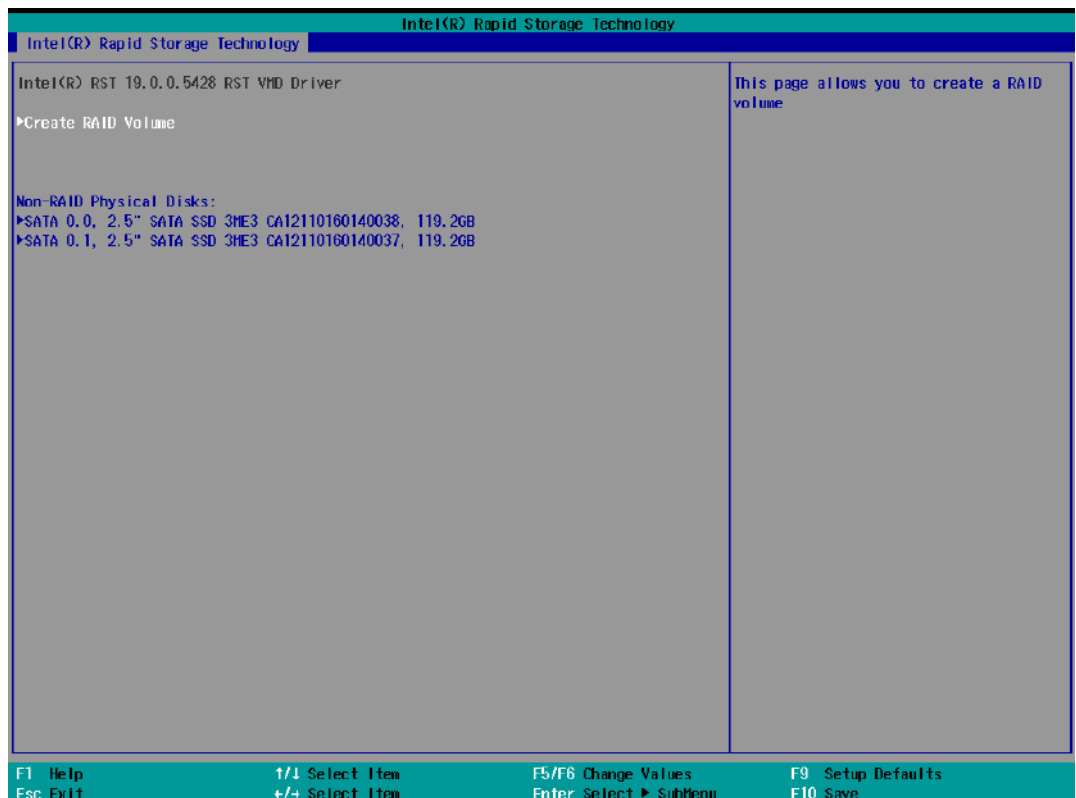

- The Name option allows you to name your RAID volume. Press ENTER when ready to go to the next option.

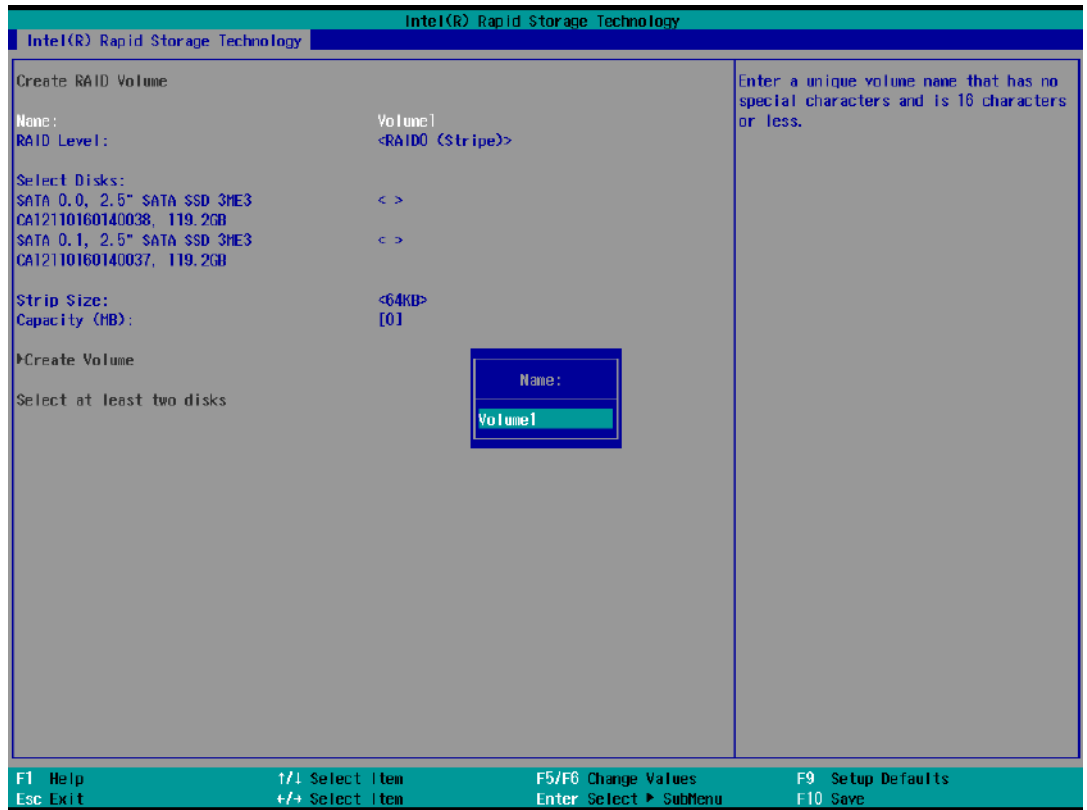



- The RAID Level option allows you to select RAID-0 (striping) or RAID-1 (mirror) for your RAID volume. Press ENTER when ready.



- The Select Disks option allows you to select disk drives for your RAID volume. Highlight a drive and press ENTER, use up/ down arrow keys to highlight "x" and press ENTER to confirm the selection. A minimum of two disk drives must be selected for RAID-0 or RAID-1 configuration. Press ENTER when ready.

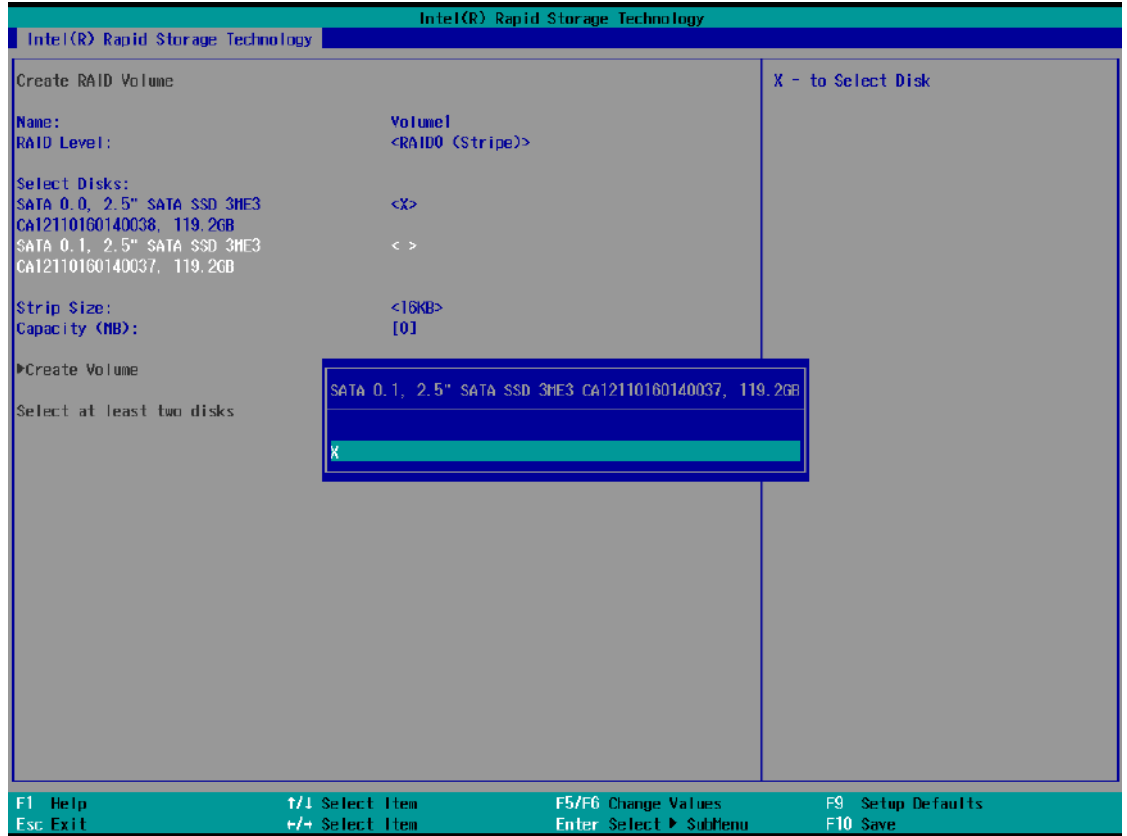

6. The Stripe Size option allows you to configure the stripe size of your RAID volume. Available stripe sizes are 4KB, 8KB, 16KB, 32KB, 64KB, 128KB, use the up and down arrow keys to highlight and press ENTER to confirm the stripe size selection.

\*RAID1(Mirror) does not offer Stripe Size options.

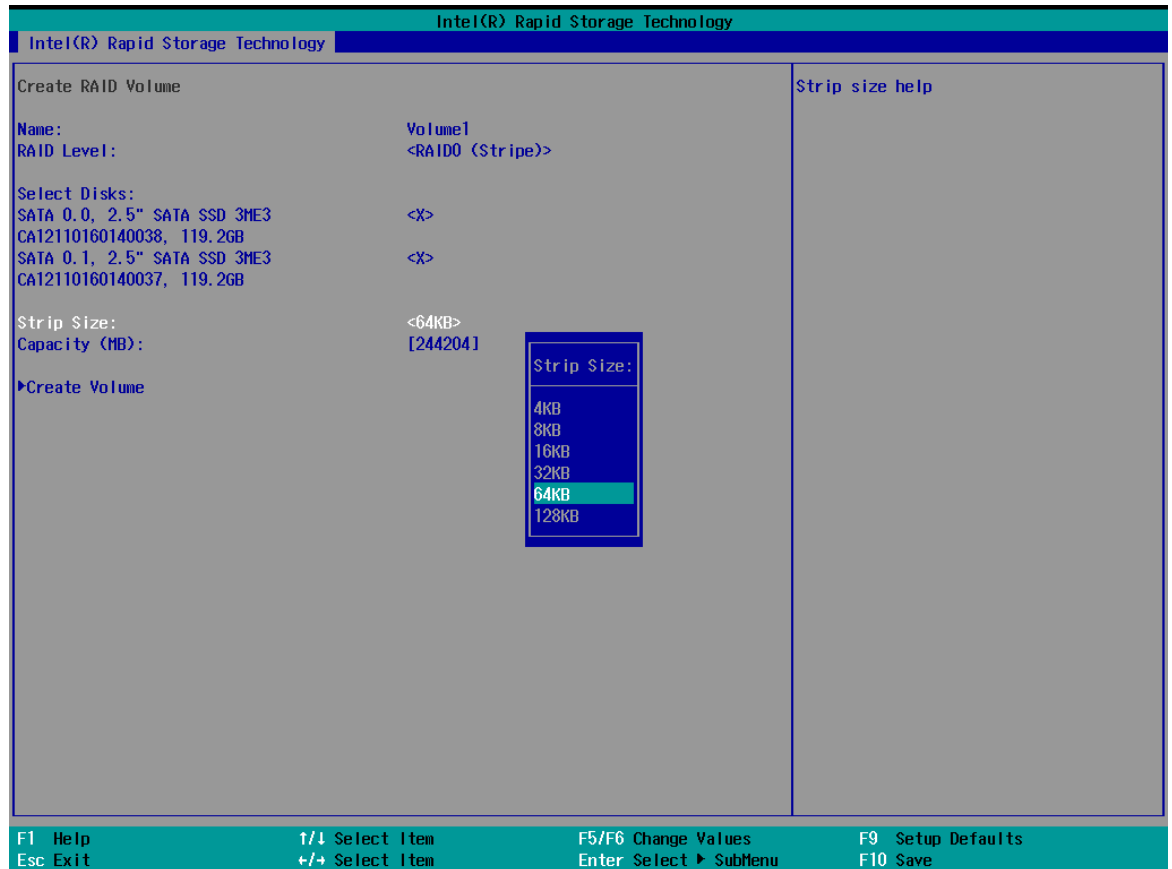

- The Capacity (MB) option allows you to configure the storage capacity of your RAID volume. By default, the full storage capacity will be applied. Once you have entered a capacity, press ENTER to confirm.



- The Create Volume option is the final step in the volume creation process. Highlight “**Create Volume**” and press ENTER to begin creating your RAID volume base on the settings you just configured.

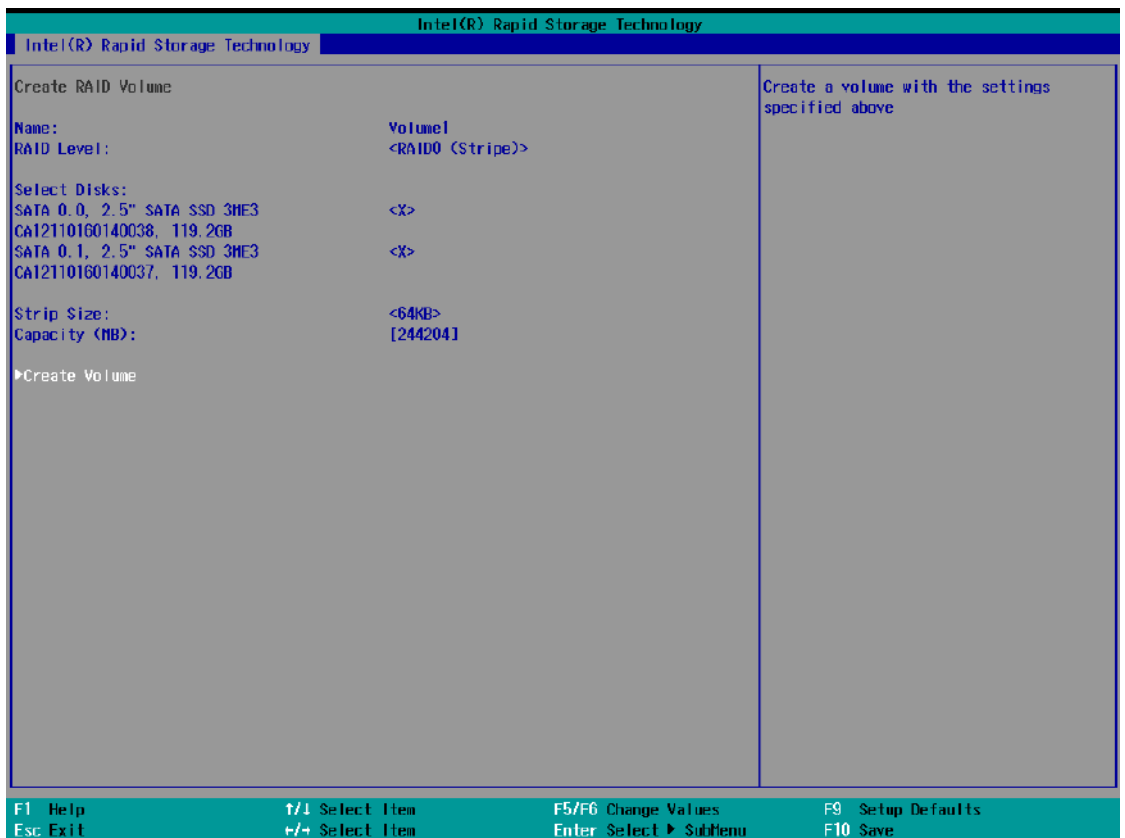

- A summary and status of the RAID volume will be shown when the RAID volume is successfully created.

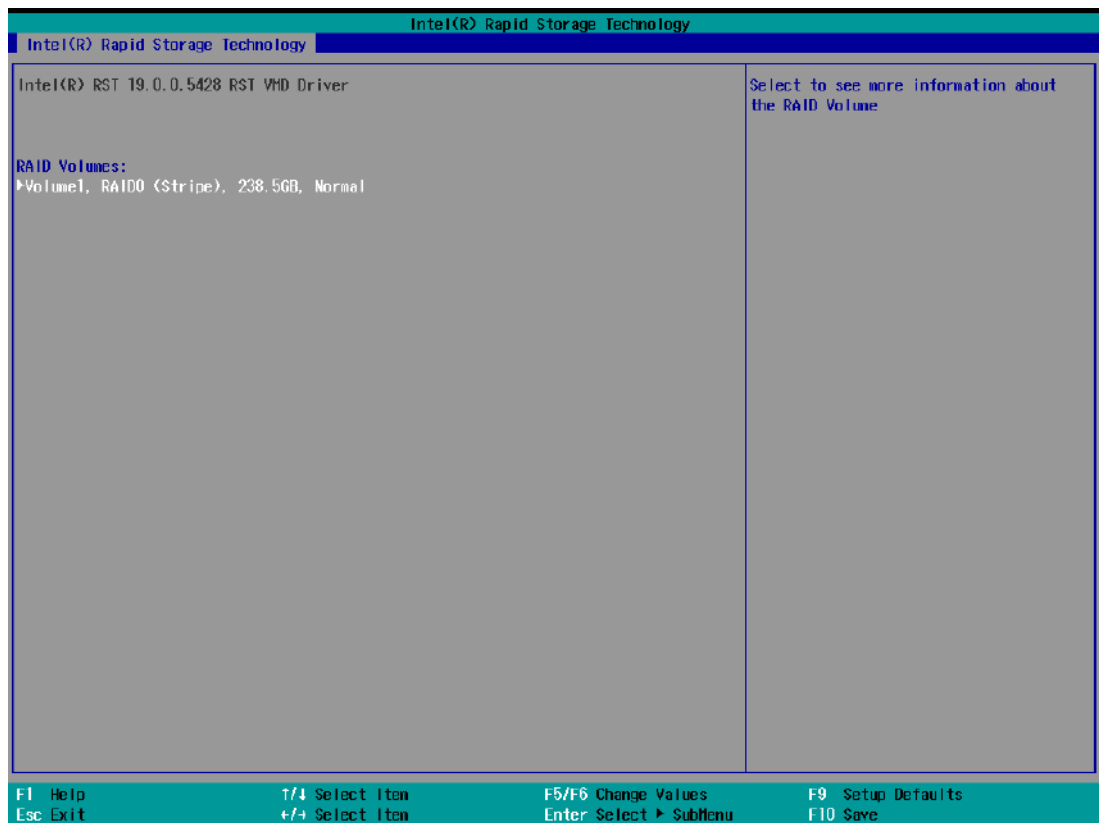

- Press F10 to save and Esc to exit the Intel® Rapid Storage Technology configuration page.



**NOTE**

*The above process was to create a RAID-0 volume. If you wish to create a RAID-1 volume, please perform RAID Volume Setup process and select RAID-1 (Mirror) during step 4.*

### 4.3.3 Loading RAID Driver for Windows Installation

To install Windows on the RAID volume you created, please refer to the following procedure:

1. Please prepare a bootable Windows installation USB drive with the zip file "[f6vmdflpy-x64](#)". Download and unzip the driver files, copy the driver files onto the Windows installation USB drive.
2. Connect the Windows installation USB drive into one of the USB connections on Nuvo-9000.
3. Windows installation process should automatically begin (if not, please make sure the boot device in BIOS is set properly).
4. Select the "Load Driver" icon.

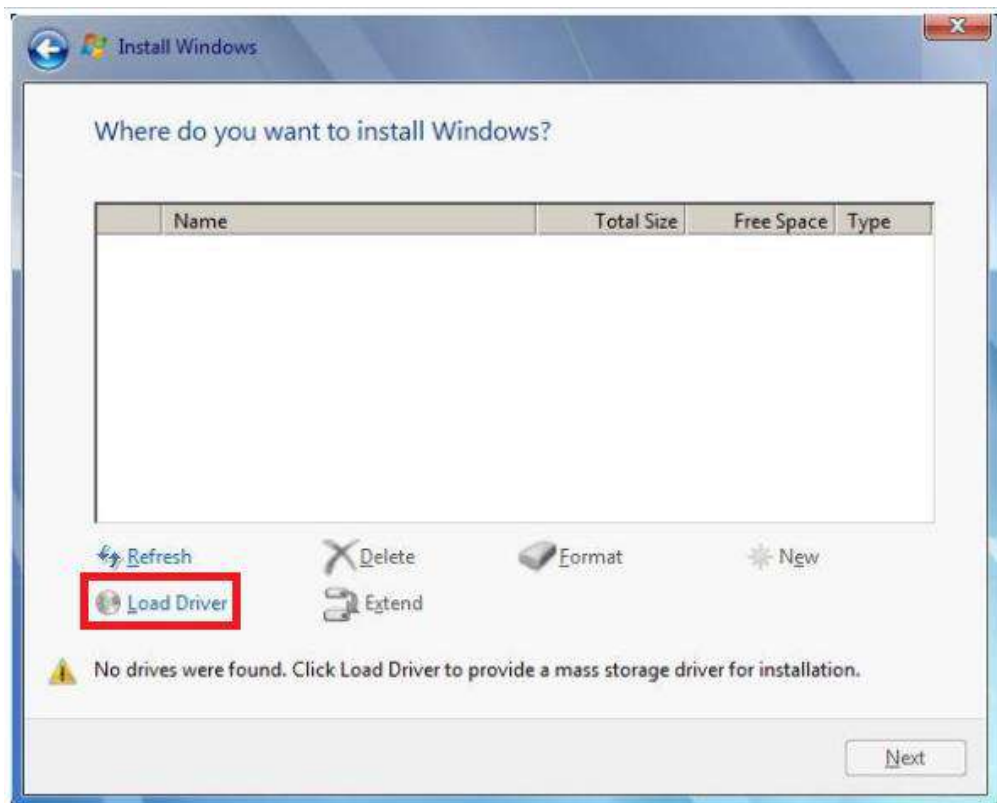



5. In the pop-up Window, select “Browse”, go to the directory where you saved the unzipped drivers “f6vmdflpy-x64”, and click OK.

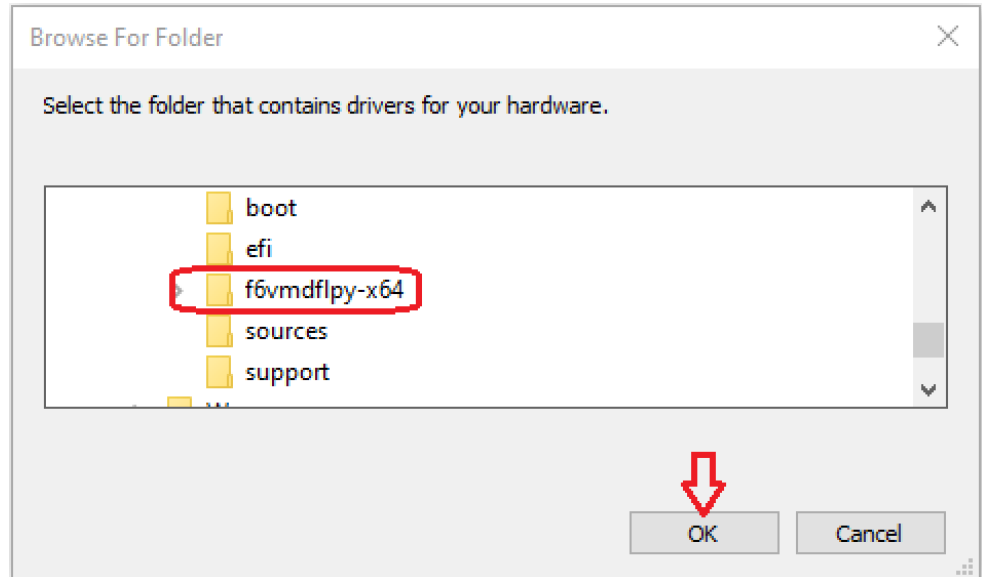
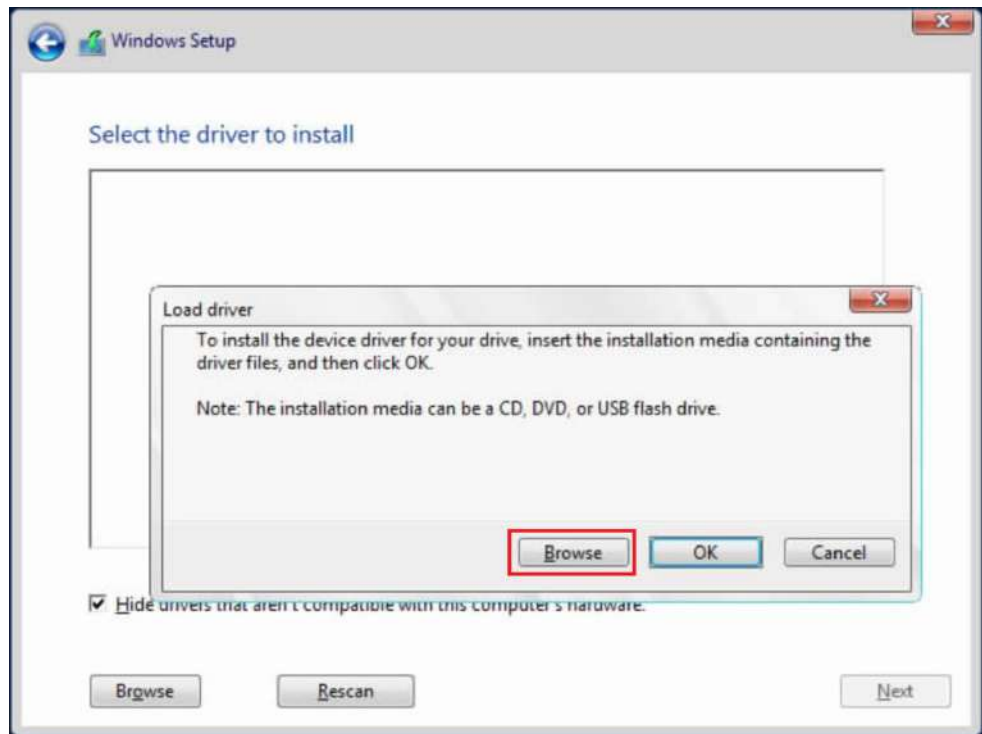

- 6. Select the driver "Intel RST VMD Controller 467F" and click on Next.

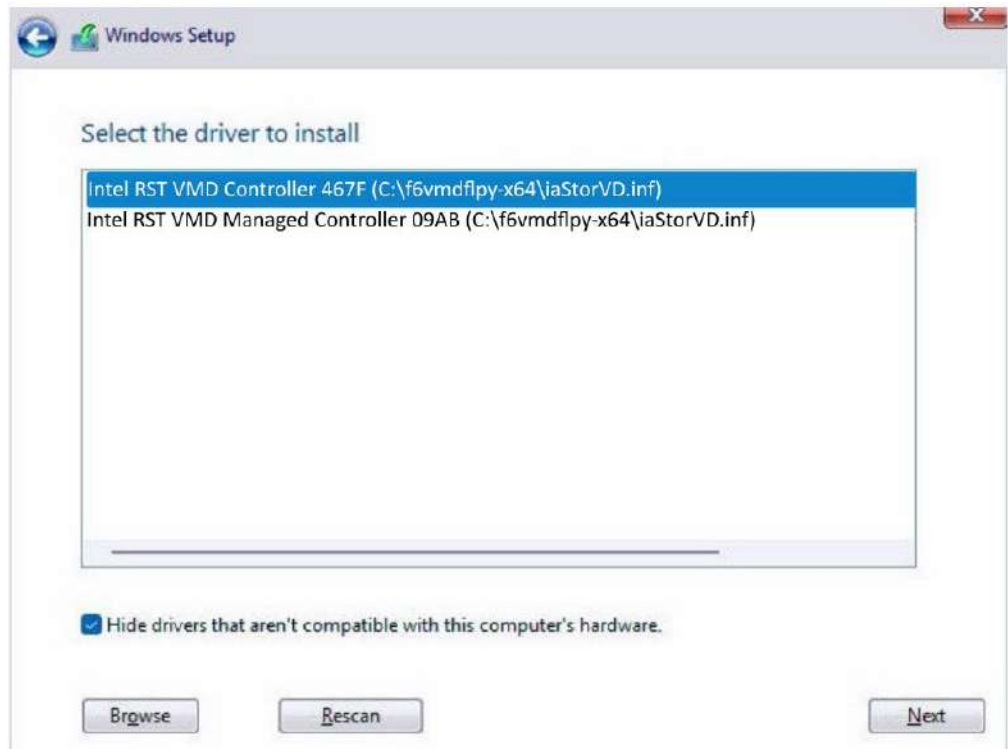

- 7. The previous created RAID volume shall appear as unallocated space.

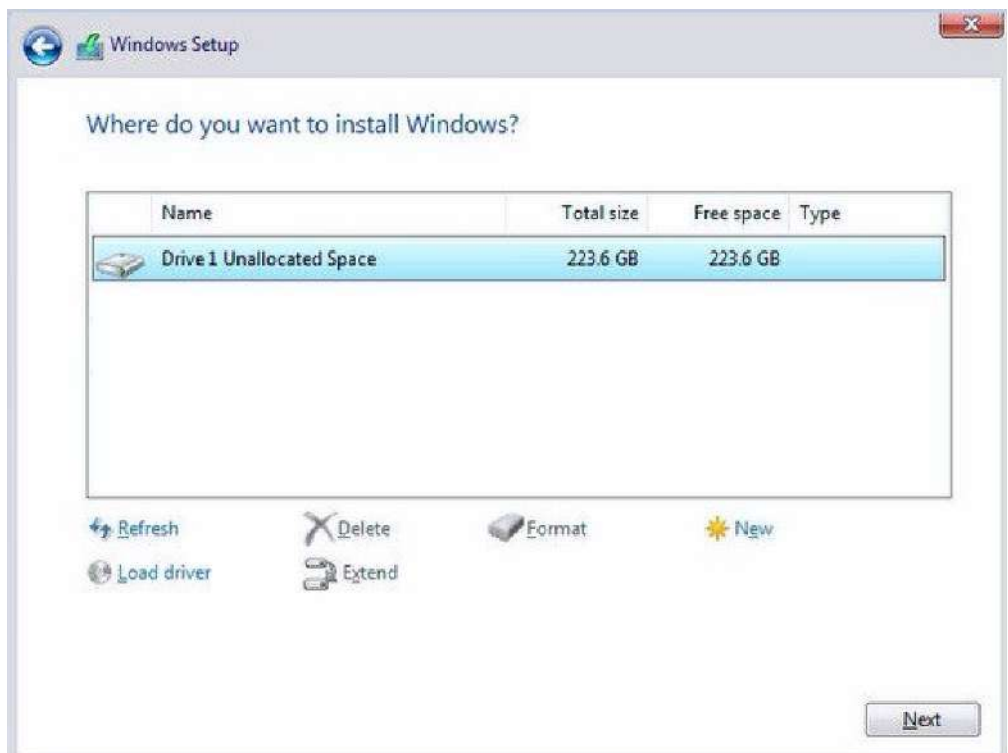

- 8. From here, just follow the standard Windows installation procedures.

## 5 OS Support and Driver Installation

### 5.1 Operating System Compatibility

The system supports most operating system developed for Intel® x86 architecture. The following list contains the operating systems which have been tested by Neousys Technology.

- Microsoft Window 10 LTSC 2021 (x64)
- Ubuntu 20.04.5 LTS, 22.04 LTS, 22.04.1 LTS or other distribution with kernel version  $\geq 5.15$   
\*/\*\*



#### NOTE

*\* For Linux system, user may need to manually compile and install the driver for Intel graphics or I225/ I226 GbE controller if the driver is not embedded in kernel. You can visit Intel website for further information.*

*\*\* For distributions, graphics driver and RAID function may not be completely implemented in its kernel. You may encounter restrictions when using these features, such as triple independent display and RAID. For optimum operation, it is the users' responsibility to manually check for new drivers and upgrades!*

Neousys may remove or update operating system compatibility without prior notice. Please contact us if your operating system of choice is not on the list.

## 5.2 System Driver Installation

The system drivers are available online, please click on respective series [Nuvo-9100VTC/](#)  
[Nuvo-9200VTC](#) to download the drivers.

## 5.3 Driver Installation for Watchdog Timer Control

Neosys provides a driver package which contain function APIs for Watchdog Timer control function. You should install the driver package (WDT\_DIO\_Setup.exe) in prior to use these functions. Please download the latest version for compatibility.

Please refer to respective series [Nuvo-9100VTC/](#) [Nuvo-9200VTC](#) to download WDT\_DIO.

# Appendix A Using WDT & DIO

The watchdog timer (WDT) function to ensure reliable system operation. The WDT is a hardware mechanism to reset the system if the watchdog timer is expired. Users can start the WDT and keeping resetting the timer to make sure the system or program is running. Otherwise, the system shall be reset.

In this section, we'll illustrate how to use the function library provided by Neosys to program the WDT functions. Currently, WDT driver library supports Windows 10 x64 and WOW64 platform. For other OS support, please contact Neosys Technology for further information.

## Installing WDT\_DIO Library

The WDT\_DIO function library is delivered in the form of a setup package named **WDT\_DIO\_Setup.exe**. In prior to program WDT, you should execute the setup program and install the WDT library. Please use the following WDT\_DIO\_Setup packages according to your operating systems and application.

- For Windows 10 64-bit OS with 64-bit application (x64 mode), please install the latest WDT\_DIO\_Setup\_.exe file. Please click on the respective series [Nuvo-9100VTC/](#) [Nuvo-9200VTC](#) to download WDT\_DIO.

## WDT and DIO Library Installation

To setup WDT & DIO Library, please follow instructions below.

1. Execute **WDT\_DIO\_Setup.exe** and the following dialog appears.

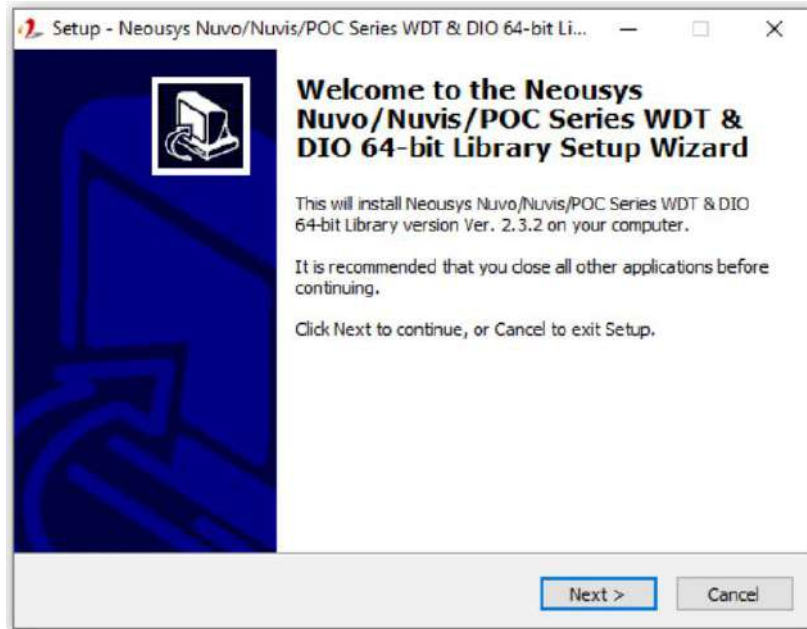

2. Click "Next >" and specify the directory of installing related files. The default directory is *C:\Neosys\WDT\_DIO*.

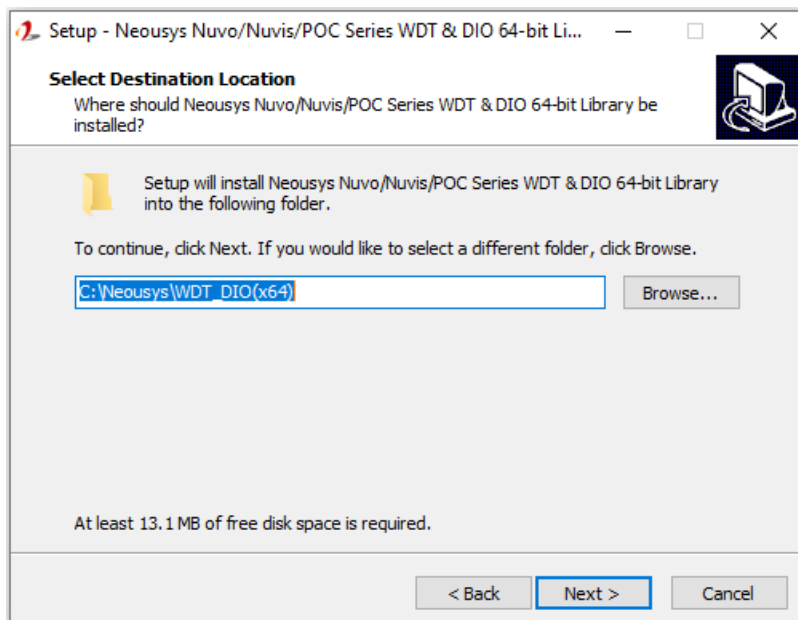



- Once the installation has finished, a dialog will appear to prompt you to reboot the system. The WDT & DIO library will take effect after the system has rebooted.

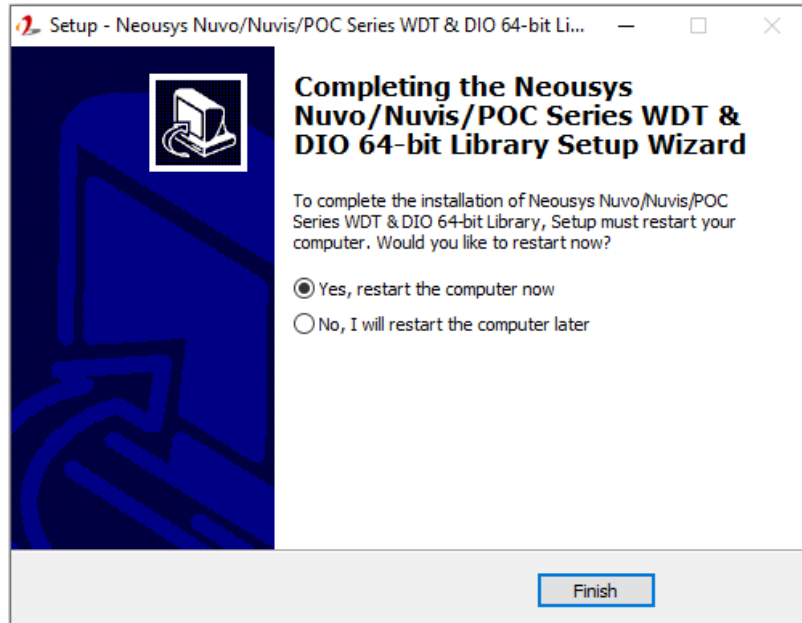

- When programming your WDT or DIO program, the related files are located in

<b>Header File:</b>	\Include
<b>Library File:</b>	\Lib
<b>Function</b>	\Manual
<b>Reference:</b>	
<b>Sample Code:</b>	\Sample\WDT_Demo (Demo for Watchdog Timer)

## WDT Functions

### InitWDT

<b>Syntax</b>	BOOL InitWDT(void);
<b>Description:</b>	Initialize the WDT function. You should always invoke InitWDT() before set or start watchdog timer.
<b>Parameter</b>	None
<b>Return Value</b>	<b>TRUE:</b> Successfully initialized <b>FALSE:</b> Failed to initialize
<b>Usage</b>	BOOL    bRet = InitWDT()

### SetWDT

<b>Syntax</b>	BOOL SetWDT(WORD tick, BYTE unit);
<b>Description</b>	Set timeout value and unit for watchdog timer. When InitWDT() is invoked, a default timeout value of 255 seconds is assigned.
<b>Parameter</b>	<i>tick</i> WORD value (1 ~ 65535) to indicate timeout ticks. <i>unit</i> BYTE value (0 or 1) to indicate unit of timeout ticks. 0 : unit is minute 1 : unit is second
<b>Return Value</b>	If value of unit is correct (0 or 1), this function returns TRUE, otherwise FALSE.
<b>Usage</b>	WORD    tick=255; BYTE    unit=1; //unit is second. BOOL    bRet = SetWDT(tick, unit); //timeout value is 255 seconds

## StartWDT

<b>Syntax</b>	BOOL StartWDT(void);
<b>Description</b>	Starts WDT countdown. Once started, the WDT LED indicator will begin blinking. If ResetWDT() or StopWDT is not invoked before WDT countdowns to 0, the WDT expires and the system resets.
<b>Parameter</b>	None
<b>Return Value</b>	If the timeout value is given in correct format (WDT started), this function returns TRUE, otherwise FALSE
<b>Usage</b>	BOOL    bRet = StartWDT()

## ResetWDT

<b>Syntax</b>	BOOL ResetWDT(void);
<b>Description</b>	Reset the timeout value to the value given by SetWDT().If ResetWDT() or StopWDT is not invoked before WDT countdowns to 0, the WDT expires and the system resets.
<b>Parameter</b>	None
<b>Return Value</b>	Always returns TRUE
<b>Usage</b>	BOOL    bRet = ResetWDT()

## StopWDT

<b>Syntax</b>	BOOL StopWDT(void);
<b>Description</b>	Stops the countdown of WDT. When WDT has stopped, the WDT LED indicator stops blinking.
<b>Parameter</b>	None
<b>Return Value</b>	Always returns TRUE
<b>Usage</b>	BOOL    bRet = StopWDT()

# Appendix B PoE On/ Off Control

Nuvo-9000VTC series offer 802.3at PoE+ ports and users are allowed to manually turn on or off the power supply of each PoE port. This can be useful in power device (PD) fault-recovery or power reset. The APIs are part of Neousys WDT\_DIO driver package. Please follow the instructions in [Appendix A Using WDT & DIO](#) for installation before programming PoE on/off control function.



**NOTE**

Nuvo-9100VTC series will be shown in illustrations for demonstration purposes.

## GetStatusPoEPort

<b>Syntax</b>	BYTE GetStatusPoEPort (Byte port);
<b>Description</b>	Get current on/off status of designated PoE port.
<b>Parameter</b>	<i>port</i>  BYTE value specifies the index of PoE port. Please refer to the following illustration, <i>port</i> should be a value of 1 ~ 8
<b>Return Value</b>	BYTE value indicating PoE on/off status 0 if port is disabled (off) 1 if port is enabled (on)
<b>Usage</b>	BYTE bEnabled = GetStatusPoEPort (1); //Get on/off status of PoE Port#1

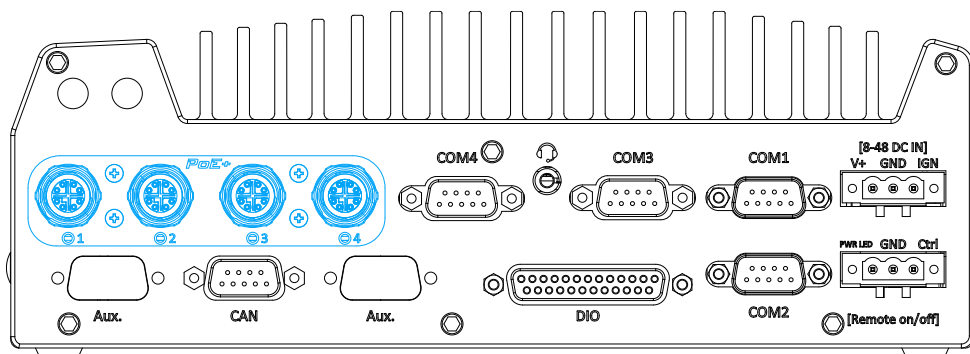

PoE ports 1 – 4 on rear panel

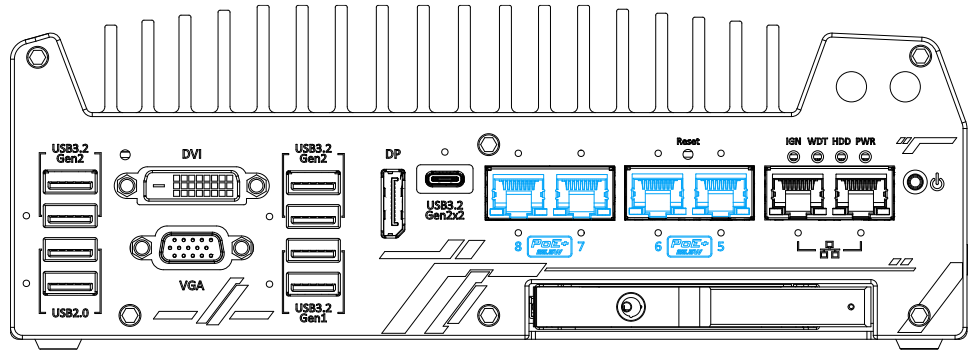

PoE ports 5 – 8 on front panel

## EnablePoEPort

<b>Syntax</b>	BOOL EnablePoEPort (BYTE port);
<b>Description</b>	Turn on PoE power of designated PoE port.
<b>Parameter</b>	<i>port</i>  BYTE value specifies the index of PoE port. Please refer to the following illustration, <i>port</i> should be a value of 1 ~ 8
<b>Return Value</b>	<b>TRUE</b> if enabled success <b>FALSE</b> if fail to enable.
<b>Usage</b>	BOOL bRet = EnablePoEPort (1); //Turn on PoE Port#1

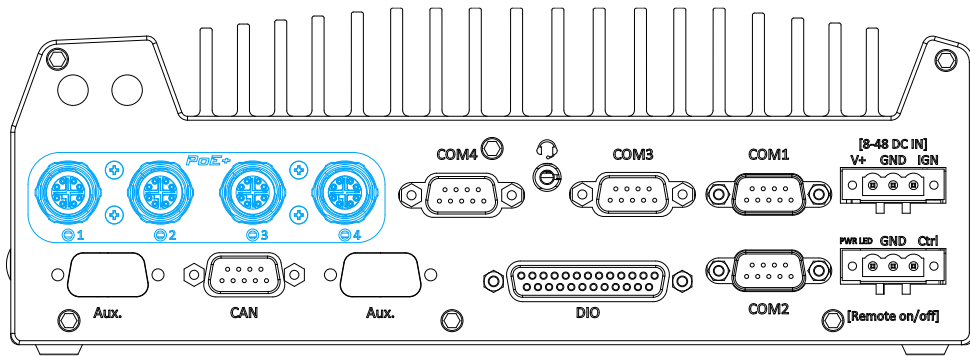

PoE ports 1 – 4 on rear panel

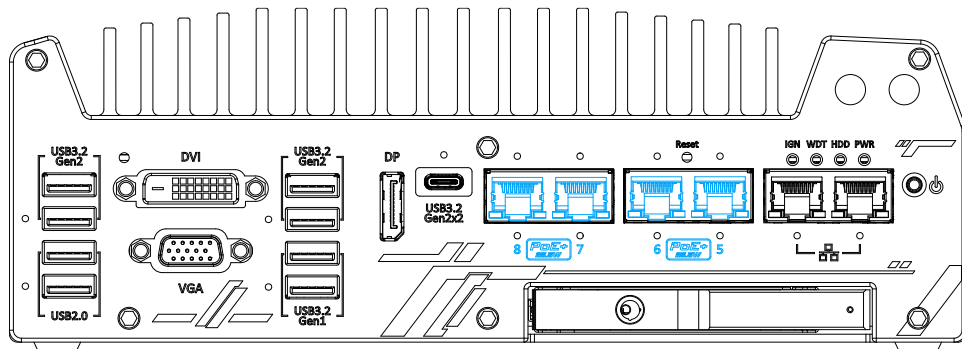

PoE ports 5 – 8 on front panel



## DisablePoEPort

<b>Syntax</b>	BOOL DisablePoEPort (BYTE port);
<b>Description</b>	Turn off PoE power of designated PoE port
<b>Parameter</b>	<p><i>port</i></p> <p>BYTE value specifies the index of PoE port. Please refer to the following illustration, <i>port</i> should be a value of 1 ~ 8</p>
<b>Return Value</b>	<p><b>TRUE</b> if disabled success</p> <p><b>FALSE</b> if fail to disable</p>
<b>Usage</b>	BOOL bRet = DisablePoEPort (1); //Turn off PoE Port#1

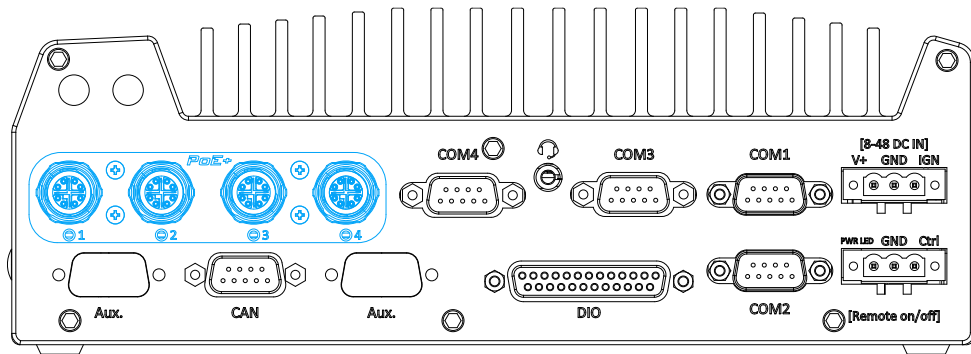

PoE ports 1 – 4 on rear panel

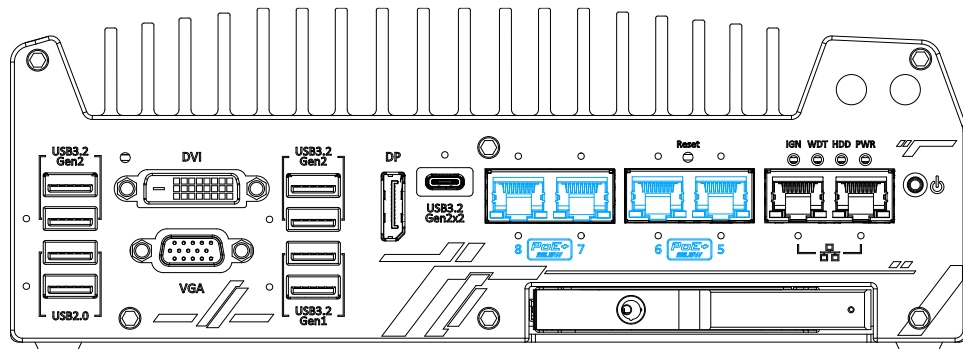

PoE ports 5 – 8 on front panel