

Features

- 10.1" New Generation Stainless Steel Panel PC
- Intel Celeron N2930 1.83GHz Onboard Processor
- True Flat Front Bezel Design and Grade 304 Stainless Steel Enclosure (Grade 316 for Option)
- IP66/IP69K Rated with M12 Connectors
- Support Resistive Touch, Projected Capacitive Touch, and Glass
- Touch on/off Button on the Side Edge for Hygienic Cleaning
- Support Ergonomic Versatile Mounting: Yoke Mounting / Space-saving VESA 75 x 75 mm Mounting

Specifications

System	
CPU	Celeron N2930 Processor(2M Cache,1.83GHz)
System Chipset	SoC
Memory	Onboard 4GB DDR3L SDRAM , up to 8GB(option)

IO Port	
USB	1 x M12 8-pin for USB 2.0 with waterproof cover and chain
Serial / Parallel	1 x M12 8-pin COM1, RS-232/422/485, default RS-232, with waterproof cover and chain
LAN	1 x M12 8-pin for LAN with waterproof cover and chain
Audio	1 x Touch on/off button on the side
Power Connector	1 x M12 3-pin for DC power with waterproof cover and chain 1 x Power switch on the side
Option	2 x optional blank M12 connector with waterproof cover and chain for selecting two from the following options: 2 x USB 2.0 1 x USB 3.0 1 x LAN (POE for option) 1 x COM 1 x CAN

Storage Space	
HDD	1 x 2.5" SATA3 HDD

Expansion	
Expansion Slot	1 x miniPCIe slot for WIFI/BT(optional), 4G/LTE(optional)
RFID module	RFID module design on the front side(optional)

Display	Standard	High Brightness Optional
Display Type	10.1" TFT-LCD	10.1" TFT-LCD
Max. Resolution	1280 x 800	1280 x 800
Max. Color	16.7M	16.7M
Luminance (cd/m ²)	350	1000
View Angle	170(H) /170(V)	170(H) /170(V)
Contrast	800:1	800:1
Backlight Lifetime	25,000 hrs	30,000 hrs

Touch Screen	
Type	Resistive Touch (For R model) Projected Capacitive Touch (For P model) Glass (For G model)
Interface	USB
Light Transmission(%)	Resistive Touch : 80% Projected Capacitive : 90%

Power	
Power Input	DC 9~36V
Power Consumption	ViTAM-810P:17W

Dimensions

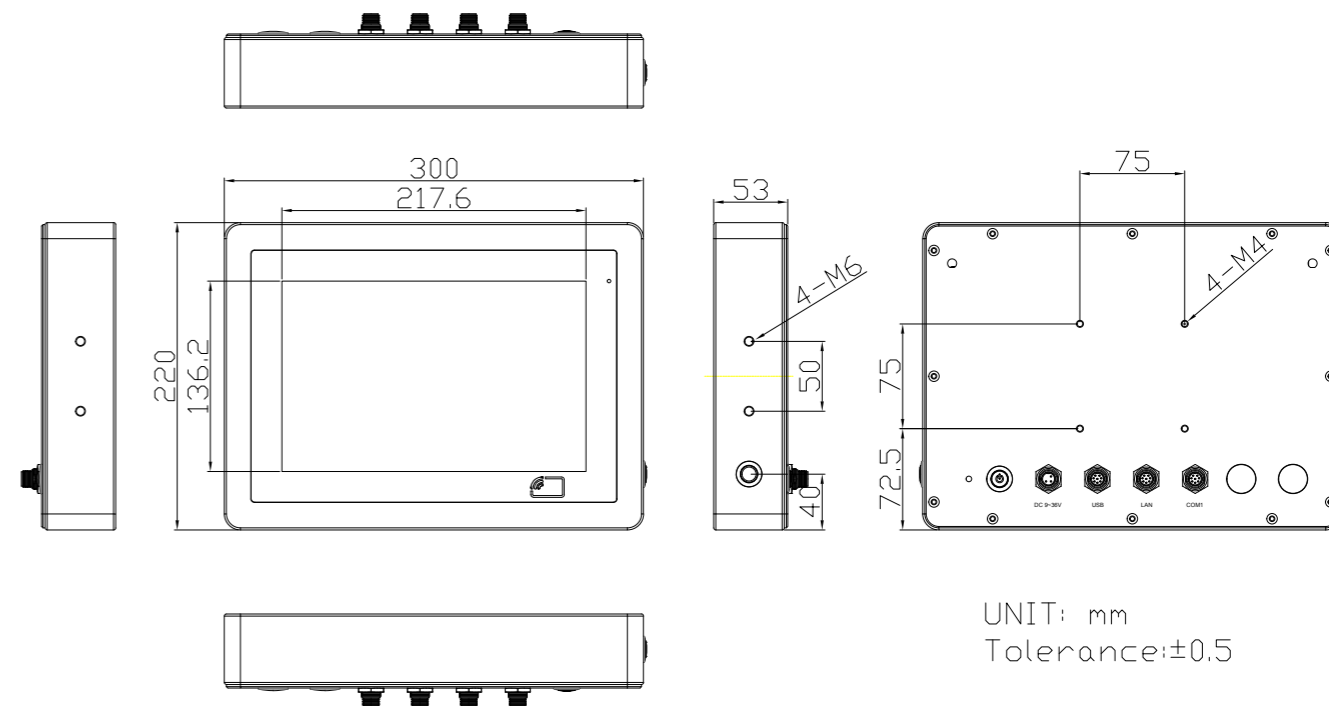

UNIT: mm
Tolerance:±0.5

Mechanical	
Construction	304 Stainless steel chassis(default), 316 Stainless steel chassis(optional)
Mounting	VESA mount 75 x 75, Yoke mount for optional
IP Rating	Total IP66/IP69K
Dimensions	300 x 220 x 53 mm
Net Weight	3.9 kg

Environmental	
Operating Temperature	0~50°C
Storage Temperature	-30~70°C
Storage Humidity	10 to 90% @ 40°C, non- condensing
Certificate	CE/FCC Class A

Operating System Support	
WEC 7, Windows Embedded 7, Windows Embedded 8.1, Windows 10 IoT ENT LTSC	

Ordering Information	
ViTAM-810P	10.1" WXGA IP66/IP69K stainless steel panel pc, Celeron N2930 Processor, 4GB DDR3L RAM, 32G MLC SSD, projected capacitive touch, 9~36V DC power input with Adapter
ViTAM-810R	10.1" WXGA IP66/IP69K stainless steel panel pc, Celeron N2930 Processor, 4GB DDR3L RAM, 32G MLC SSD, 5 wire resistive touch window, 9~36V DC power input with Adapter
ViTAM-810G	10.1" WXGA IP66/IP69K stainless steel panel pc, Celeron N2930 Processor, 4GB DDR3L RAM, 32G MLC SSD, protection glass, 9~36V DC power input with Adapter
ViTAM-810PH	10.1" WXGA IP66/IP69K stainless steel panel pc, Celeron N2930 Processor, 4GB DDR3L RAM, 32G MLC SSD, projected capacitive touch, 9~36V DC power input with Adapter, 1,000 nits LCD
ViTAM-810RH	10.1" WXGA IP66/IP69K stainless steel panel pc, Celeron N2930 Processor, 4GB DDR3L RAM, 32G MLC SSD, 5 wire resistive touch window, 9~36V DC power input with Adapter, 1,000 nits LCD
ViTAM-810GH	10.1" WXGA IP66/IP69K stainless steel panel pc, Celeron N2930 Processor, 4GB DDR3L RAM, 32G MLC SSD, protection glass, 9~36V DC power input with Adapter, 1,000 nits LCD