

Neosys Technology Inc.

SEMIL-1300 Series

User Manual

Revision 1.3

Table of Contents

Table of Contents	2
Legal Information	5
Contact Information	6
Declaration of Conformity	6
Copyright Notice	7
Safety Precautions	8
Battery Warning	8
Service and Maintenance	9
ESD Precautions	9
Restricted Access Location	9
About This Manual	10
1 Introduction	
1.1 SEMIL-1300 Series Overview	11
1.2 SEMIL-1301 Specifications	12
1.3 SEMIL-1311J Specifications	14
1.4 Dimension	16
1.4.1 Superior View	16
1.4.2 Front Panel View	17
1.4.3 Side View	17
1.4.4 Bottom View	18
1.4.5 Rear Panel Dimensions & Antenna Opening	19
1.5 Dimensions with Wall Mount Bracket	20
1.5.1 Front View	20
1.5.2 Bottom View	20
2 System Overview	
2.1 SEMIL-1300 Packing List	21
2.2 SEMIL-1300 Front Panel	22
2.2.1 Power Button	23
2.2.2 3-pin Terminal Block for DC and Ignition Input	23
2.2.3 DisplayPort	24
2.2.4 PoE+ Gigabit Ethernet Port	25
2.2.5 USB3.1 Gen 1 Port	26
2.2.6 3.5mm 4-pole Audio Jack	26
2.2.7 COM Port 4	27
2.2.8 USB2.0 Port	28
2.2.9 VGA Port	29
2.2.10 COM Port 3	31
2.2.11 COM1/ COM2 Port	32
2.2.12 Optional 10Gb Ethernet	33
2.3 Internal I/Os	34
2.3.1 M.2 3042/ 3052 B Key Module Expansion Slot & Corresponding SIM Slots	34
2.3.2 M.2 2242 E Key Module Expansion Slot	36
2.3.3 mini-PCIe Expansion Slot (mux with mSATA)	39
2.3.4 Ignition Control Rotary Switch	41
3 Installation	
3.1 M.2 Module & SIM card Installation	42
3.2 mini-PCIe Module Installation	48
3.3 Hard Drive Installation	55
3.4 Wall-mount Bracket Installation	60
3.5 Rack-mount Bracket Installation (Optional Accessory)	61
3.6 Ignition Power Control	63
3.6.1 Principles of Ignition Power Control	63

3.6.2	Additional Features of Ignition Power Control	64
3.6.3	Wiring Ignition Signal	65
3.6.4	Configure your Windows system for Ignition Control	66
3.7	Accessing the Rotary Switch	67
3.8	Operation Modes of Ignition Power Control	68
3.9	Reinstalling the Backplate.....	70
3.10	Ignition Control Setup.....	71

4 System Configuration

4.1	BIOS Settings	74
4.1.1	COM Port Configuration.....	75
4.1.2	COM Port High Speed Mode	76
4.1.3	SATA Configuration.....	77
4.1.4	TPM Availability.....	79
4.1.5	Auto Wake on S5	80
4.1.6	Power On After Power Failure Option	81
4.1.7	Power & Performance (CPU SKU Power Configuration)	82
4.1.8	Wake on LAN Option	83
4.1.9	Boot Menu	84
4.1.10	Boot Type (Legacy/ UEFI).....	86
4.1.11	Boot Option for Newly Added Device	88
4.1.12	Watchdog Timer for Booting.....	89
4.1.13	Selecting Legacy/ UEFI Boot Device	90
4.2	AMT Configuration	91
4.3	RAID Volume Configuration.....	93
4.3.1	Legacy Mode RAID Configuration.....	93
4.3.2	UEFI Mode RAID Configuration	99

5 OS Support and Driver Installation

5.1	Operating System Compatibility	110
5.2	Install Drivers Automatically	111
5.2.1	Install Drivers Automatically	111
5.3	Install Drivers Manually	112
5.3.1	For Windows 10 (x64).....	112
5.4	Driver Installation for Watchdog Timer Control.....	113
5.5	Intel® Optane™ Memory BIOS Setup and Driver Installation.....	114

6 CAP Energy Management Technology ~ Power Backup Parameter

Configurer

6.1	CAP Energy Management Technology	123
6.2	Power Backup Parameter Configurer	124
6.2.1	Executing PB2500J Parameter Configurer	124
6.2.2	PB-2500J Parameter Configurer.....	125
6.2.3	Auto-start	126
6.2.4	Behavior for DC Loss (<9V).....	127
6.2.5	Shutdown at Low Voltage	128
6.2.6	Shutdown at High Voltage.....	129
6.2.7	SuperCAP Lifetime Extension.....	130
6.2.8	Update Parameters.....	131
6.2.9	Get Parameters.....	132
6.2.10	Load Default.....	133
6.2.11	Re-train	134
6.2.12	Reset	135

Appendix A: Using WDT & DIO

WDT and DIO Library Installation	137
WDT Function Reference	139

InitWDT	139
SetWDT	139
StartWDT	140
ResetWDT	140
StopWDT	140

Appendix B: PoE On/ Off Control

GetStatusPoEPort.....	142
EnablePoEPort.....	143
DisablePoEPort.....	144

Legal Information

All Neosys Technology Inc. products shall be subject to the latest Standard Warranty Policy

Neosys Technology Inc. may modify, update or upgrade the software, firmware or any accompanying user documentation without any prior notice. Neosys Technology Inc. will provide access to these new software, firmware or documentation releases from download sections of our website or through our service partners.

Before installing any software, applications or components provided by a third party, customer should ensure that they are compatible and interoperable with Neosys Technology Inc. product by checking in advance with Neosys Technology Inc.. Customer is solely responsible for ensuring the compatibility and interoperability of the third party's products. Customer is further solely responsible for ensuring its systems, software, and data are adequately backed up as a precaution against possible failures, alternation, or loss.

For questions in regards to hardware/ software compatibility, customers should contact Neosys Technology Inc. sales representative or technical support.

To the extent permitted by applicable laws, Neosys Technology Inc. shall NOT be responsible for any interoperability or compatibility issues that may arise when (1) products, software, or options not certified and supported; (2) configurations not certified and supported are used; (3) parts intended for one system is installed in another system of different make or model.

Contact Information

Headquarters
(Taipei, Taiwan)

Neosys Technology Inc.
15F, No.868-3, Zhongzheng Rd., Zhonghe Dist., New Taipei City, 23586, Taiwan
Tel: +886-2-2223-6182 Fax: +886-2-2223-6183 [Email](#), [Website](#)

Americas
(Illinois, USA)

Neosys Technology America Inc.
3384 Commercial Avenue, Northbrook, IL 60062, USA
Tel: +1-847-656-3298 [Email](#), [Website](#)

China

Neosys Technology (China) Ltd.
Room 612, Building 32, Guiping Road 680, Shanghai
Tel: +86-2161155366 [Email](#), [Website](#)

Declaration of Conformity

FCC

This equipment has been tested and found to comply with the limits for a Class A digital device, pursuant to part 15 of the FCC Rules. These limits are designed to provide reasonable protection against harmful interference when the equipment is operated in a commercial environment. This equipment generates, uses, and can radiate radio frequency energy and, if not installed and used in accordance with the instruction manual, may cause harmful interference to radio communications. Operation of this equipment in a residential area is likely to cause harmful interference in which case the user will be required to correct the interference at own expense.

CE

The product(s) described in this manual complies with all applicable European Union (CE) directives if it has a CE marking. For computer systems to remain CE compliant, only CE-compliant parts may be used. Maintaining CE compliance also requires proper cable and cabling techniques.

Copyright Notice

All rights reserved. This publication may not be reproduced, transmitted, transcribed, stored in a retrieval system, or translated into any language or computer language, in any form or by any means, electronic, mechanical, magnetic, optical, chemical, manual or otherwise, without the prior written consent of Neosys Technology, Inc.

Disclaimer

This manual is intended to be used as an informative guide only and is subject to change without prior notice. It does not represent commitment from Neosys Technology Inc. Neosys Technology Inc. shall not be liable for any direct, indirect, special, incidental, or consequential damages arising from the use of the product or documentation, nor for any infringement on third party rights.

Patents and Trademarks

Neosys, the Neosys logo, Expansion Cassette, MezIO™ are registered patents and trademarks of Neosys Technology, Inc.

Windows is a registered trademark of Microsoft Corporation.

Intel®, Core™ is a registered trademark of Intel Corporation

NVIDIA®, GeForce® is a registered trademark of NVIDIA Corporation

Texas Instruments (TI) and Sitara are registered trademarks of Texas Instruments Incorporated.

All other names, brands, products or services are trademarks or registered trademarks of their respective owners.

Safety Precautions

- Read these instructions carefully before you install, operate, or transport the system.
- Install the system or DIN rail associated with, at a sturdy location
- Install the power socket outlet near the system where it is easily accessible
- Secure each system module(s) using its retaining screws
- Place power cords and other connection cables away from foot traffic. Do not place items over power cords and make sure they do not rest against data cables
- Shutdown, disconnect all cables from the system and ground yourself before touching internal modules
- Ensure that the correct power range is being used before powering the device
- Should a module fail, arrange for a replacement as soon as possible to minimize down-time
- If the system is not going to be used for a long time, disconnect it from mains (power socket) to avoid transient over-voltage

Battery Warning

- Batteries are at risk of exploding if incorrectly installed
- Do not attempt to recharge, force open, or heat the battery
- Replace the battery only with the same or equivalent type recommended by the manufacturer

Caution!



Service and Maintenance

- ONLY qualified personnel should service the system
- Shutdown the system, disconnect the power cord and all other connections before servicing the system
- When replacing/ installing additional components (expansion card, memory module, etc.), insert them as gently as possible while assuring connectors are properly engaged

ESD Precautions

- Handle add-on module, motherboard by their retention screws or the module's frame/ heat sink. Avoid touching the PCB circuit board or add-on module connector pins
- Use a grounded wrist strap and an anti-static work pad to discharge static electricity when installing or maintaining the system
- Avoid dust, debris, carpets, plastic, vinyl and Styrofoam in your work area.
- Do not remove any module or component from its anti-static bag before installation

Restricted Access Location

The controller is intended for installation only in the certain environment where both these condition apply:

- Access can only be gained by SERVICE PERSONS or by USERS who have been instructed about the reasons for the restrictions applied to the location and about any precautions that shall be taken
- Access is through the use of a TOOL or lock and key, or other means of security, and is controlled by the authority responsible for the location

About This Manual

This manual introduces Neosys Technology SEMIL-1300 series, an extreme-rugged fanless computer featuring workstation-grade Intel® chipset and offers excellent passive thermal performance with M12 and screw-lock connectors for robust and cost-effectiveness.

Applicable systems

Model No.	Description
SEMIL-1301	Half-rack rugged fanless computer including Intel® Xeon® E or 9th / 8th-Gen Core™ processor with M12 I/Os
SEMIL-1301-10G	Half-rack rugged fanless computer including Intel® Xeon® E or 9th / 8th-Gen Core™ processor with M12 I/Os and 10GbE port.
SEMIL-1311J	Half-rack rugged fanless computer including Intel® Xeon® E or 9th / 8th-Gen Core™ processor with M12 I/Os and SuperCAP UPS
SEMIL-1311J-10G	Half-rack rugged fanless computer including Intel® Xeon® E or 9th / 8th-Gen Core™ processor with M12 I/Os, SuperCAP UPS and 10GbE port

Revision History

Version	Date	Description
1.0	Mar. 2023	Initial release
1.1	Apr. 2023	Dimension update
1.2	Nov. 2023	Updated ignition power control, supercapacitor configuration, and optional 10G Ethernet descriptions
1.3	Jan. 2024	Updated “PB2500J Parameter Configurer” connection setting to COM5 port

1 Introduction

SEMIL-1300 series is a rugged fanless computer with robust M12 I/O connectors in a standard 2U 19" half-rack form factor enclosure. Powered by Intel® Xeon® E or 9th/ 8th-Gen Core™ CPU and coupled with workstation-grade Intel® C246 chipset, it supports up to 64 GB DDR4 ECC/non-ECC memory and offers flexible mounting options to wall or rack-mount up to two SEMILs side by side.

1.1 SEMIL-1300 Series Overview

SEMIL-1300 series incorporates Neosys' best-in-class passive thermal design for proven -40°C to 70°C fanless operation. It offers a variety of I/O connectivities utilizing M12 connectors that are reliably robust, cost-effective and can be obtained off-the-shelf. There are also generic I/Os with screw-lock mechanisms to guarantee an extreme-rugged connection in shock and vibration environments. It has four 802.3at PoE+ ports, each supplying 25W of power to the connected device such as an IP or GigE camera. SEMIL-1300 is designed with 4G/5G and WiFi5/WiFi6 wireless connectivity in mind and it supports 8-48V wide-range DC input with ignition power control for in-vehicle use while complying with EN 50155.



In addition, SEMIL-1311J is equipped with Neosys' patented SuperCAP-based UPS containing 2500 watt-second stored energy to sustain and safely shut down the system during unforeseen power outages. It is the perfect solution for data protection and applications in unstable power environments. With a standard half-rack design, proven wide temperature operation capability, protected against shock/ vibration and power interruption, Neosys' SEMIL-1300 series is the ideal robust solution for extreme-rugged deployment.

1.2 SEMIL-1301 Specifications

System Platform	
Processor	Supporting Intel® Xeon® E and 9 th / 8 th -Gen CPU (LGA1151 socket) - Xeon E 2176G (6C/12T) / 2278GE (8C/16T) / 2278GEL (8C/16T) - Intel® Core™ i7-9700TE/ i7-9700E/ i7-8700T/ i7-8700 - Intel® Core™ i5-9500TE/ i5-9500E/ i5-8500T/ i5-8500 - Intel® Core™ i3-9100TE/ i3-9100E/ i3-8100T/ i3-8100
Chipset	Intel® C246 platform
Graphics	Integrated Intel® HD Graphics 630
Memory	2x 260-pin SO-DIMM sockets, up to 64GB DDR4 2666/ 2400MHz SDRAM
AMT	Supports AMT 12.0
TPM	Supports TPM 2.0
I/O Interface	
PoE+	1x IEEE 802.3at (25.5W) Gigabit PoE+ ports by Intel® I219 (M12 X-coded) 3x IEEE 802.3at (25.5W) Gigabit PoE+ ports by Intel® I210 (M12 X-coded)
10 GbE Port (Build Option)	Optional: 1x 10 GbE port by Intel® X550AT controller (M12 X-coded)**
Native Video Port	1x VGA (M12 A-coded), supporting 1920 x 1200 resolution 1x DisplayPort connector, supporting 4096 x 2304 resolution
Serial Port	2x 3-wire RS-232 ports COM1 & COM2 (M12 A-coded) 1x software-programmable RS-232/ 422/ 485 port (COM3, DB9) 1x RS-232 port (COM4, DB9)
USB	3x USB 3.1 Gen1 2x USB 2.0 (M12 A-coded) 1x USB 2.0 (internal)
Audio	1x 3.5mm jack for mic-in and speaker-out
Storage Interface	
SATA HDD	2x internal SATA ports for 2.5" HDD/ SSD installation, supporting RAID 0/ 1
mSATA	2x full-size mSATA ports (mux with mini-PCIe)
M.2	1x M.2 2280 M key socket (PCIe Gen3 x4) for NVMe SSD or Intel® Optane™ memory installation
Expansion Bus	
Mini PCI-E	2x full-size mini PCI Express sockets (mux with mSATA) 1x M.2 3042/ 3052 B key socket for selected M.2 4G/ 5G module

	1x M.2 2242 E key for selected WiFi
Power Supply	
DC Input	8 to 48V DC input
Ignition Control	Built-in ignition power control
Max. Power Consumption	Intel® Xeon® E-2278GE (max.TDP) - 108.96W(24V) - 114.24W(48V) Intel® Xeon® E-2278GE (35 W) - 72.96W(24V) - 76.32W(48V)
Mechanical	
Dimension	220mm (W) x 310mm (D) x 90.5mm (H)
Weight	5.8 kg
Mounting Method	Rack-mount and wall-mount
Environmental	
Operating Temperature	With 35W CPU -40°C ~ 70°C **/ **** With >= 65W CPU -40°C ~ 70°C **/ **** (configured as 35W TDP mode) -40°C ~ 50°C **/ **** (configured as 65W TDP mode)
Storage Temperature	-40°C ~85°C
Humidity	10%~90% , non-condensing
Vibration	Operating, MIL-STD-810G, Method 514.7, Category 4
Shock	Operating, MIL-STD-810G, Method 516.7, Procedure I
EMC	EN-50155, CE/FCC Class A, according to EN 55032 & EN 55035

** For optional 10GbE support, please contact Neousys Technology

*** For Xeon E 2176G/ 2278GE, i7-9700E, and i7-8700 running at 65W mode, the highest operating temperature shall be limited to 50°C and thermal throttling may occur when sustained full-loading applied. Users can configure the CPU TDP in BIOS to obtain higher operating temperature.

**** For sub-zero operating temperature, a wide temperature HDD or Solid State Disk (SSD) is required.

1.3 SEMIL-1311J Specifications

System Platform	
Processor	Supporting Intel® Xeon® E and 9 th / 8 th -Gen CPU (LGA1151 socket) - Xeon E 2176G (6C/12T) / 2278GE (8C/16T) / 2278GEL (8C/16T) - Intel® Core™ i7-9700TE/ i7-9700E/ i7-8700T/ i7-8700 - Intel® Core™ i5-9500TE/ i5-9500E/ i5-8500T/ i5-8500 - Intel® Core™ i3-9100TE/ i3-9100E/ i3-8100T/ i3-8100
Chipset	Intel® C246 platform
Graphics	Integrated Intel® HD Graphics 630
Memory	2x 260-pin SO-DIMM sockets, up to 64GB DDR4 2666/ 2400MHz SDRAM
AMT	Supports AMT 12.0
TPM	Supports TPM 2.0
I/O Interface	
PoE+	1x IEEE 802.3at (25.5W) Gigabit PoE+ ports by Intel® I219 (M12 X-coded) 3x IEEE 802.3at (25.5W) Gigabit PoE+ ports by Intel® I210 (M12 X-coded)
10 GbE Port (Build Option)	Optional: 1x 10 GbE port by Intel® X550AT controller (M12 X-coded)**
Native Video Port	1x VGA (M12 A-coded), supporting 1920 x 1200 resolution 1x DisplayPort connector, supporting 4096 x 2304 resolution
Serial Port	2x 3-wire RS-232 ports COM1 & COM2 (M12 A-coded) 1x software-programmable RS-232/ 422/ 485 port (COM3, DB9) 1x RS-232 port (COM4, DB9)
USB	3x USB 3.1 Gen1 2x USB 2.0 (M12 A-coded) 1x USB 2.0 (internal)
Audio	1x 3.5mm jack for mic-in and seaker-out
Storage Interface	
SATA HDD	2x internal SATA ports for 2.5" HDD/ SSD installation, supporting RAID 0/ 1
mSATA	2x full-size mSATA ports (mux with mini-PCIe)
M.2	1x M.2 2280 M key socket (PCIe Gen3 x4) for NVMe SSD or Intel® Optane™ memory installation
Expansion Bus	
Mini PCI-E	2x full-size mini PCI Express sockets (mux with mSATA) 1x M.2 3042/ 3052 B key socket for selected M.2 4G/ 5G module

	1x M.2 2242 E key for selected WiFi
Power Supply	
DC Input	8 to 48V DC input
Ignition Control	Built-in ignition power control
Power Backup	
Capacity	2500 watt-second
Max. Power Consumption	Intel® Xeon® E-2278GE (max.TDP) - 108.96W(24V) - 114.24W(48V) Intel® Xeon® E-2278GE (35 W) - 72.96W(24V) - 76.32W(48V)
Mechanical	
Dimension	220mm (W) x 310mm (D) x 90.5mm (H)
Weight	6 kg
Mounting Method	Rack-mount and wall-mount
Environmental	
Operating Temperature	With 35W CPU -40°C ~ 70°C ***/ **** With >= 65W CPU -40°C ~ 70°C ***/ **** (configured as 35W TDP mode) -40°C ~ 50°C ***/ **** (configured as 65W TDP mode)
Storage Temperature	-40°C ~85°C
Humidity	10%~90% , non-condensing
Vibration	Operating, MIL-STD-810G, Method 514.7, Category 4
Shock	Operating, MIL-STD-810G, Method 516.7, Procedure I
EMC	EN-50155, CE/FCC Class A, according to EN 55032 & EN 55035

** For optional 10GbE support, please contact Neousys Technology

*** For Xeon E 2176G/ 2278GE, i7-9700E, and i7-8700 running at 65W mode, the highest operating temperature shall be limited to 50°C and thermal throttling may occur when sustained full-loading applied. Users can configure the CPU TDP in BIOS to obtain higher operating temperature.

**** For sub-zero operating temperature, a wide temperature HDD or Solid State Disk (SSD) is required.

1.4 Dimension

1.4.1 Superior View

 NOTE
All measurements are in millimeters (mm).

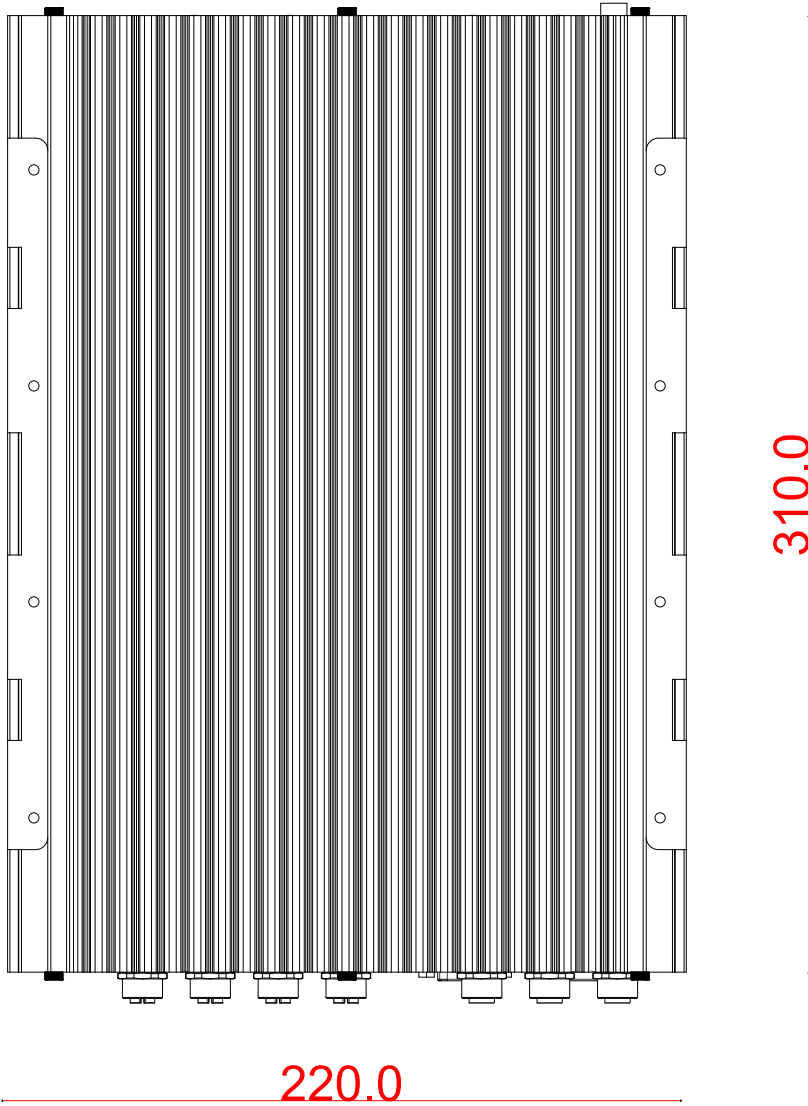

1.4.2 Front Panel View

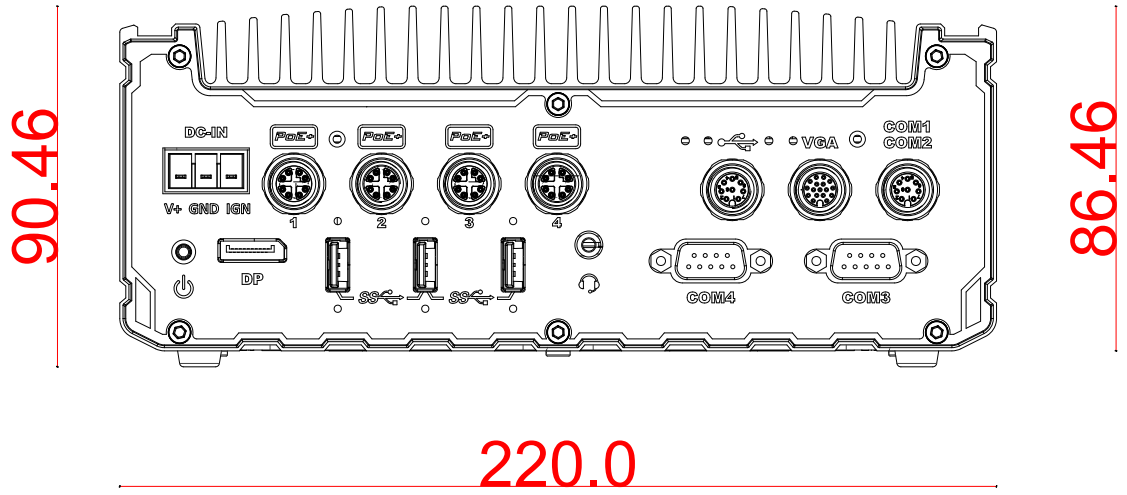

1.4.3 Side View

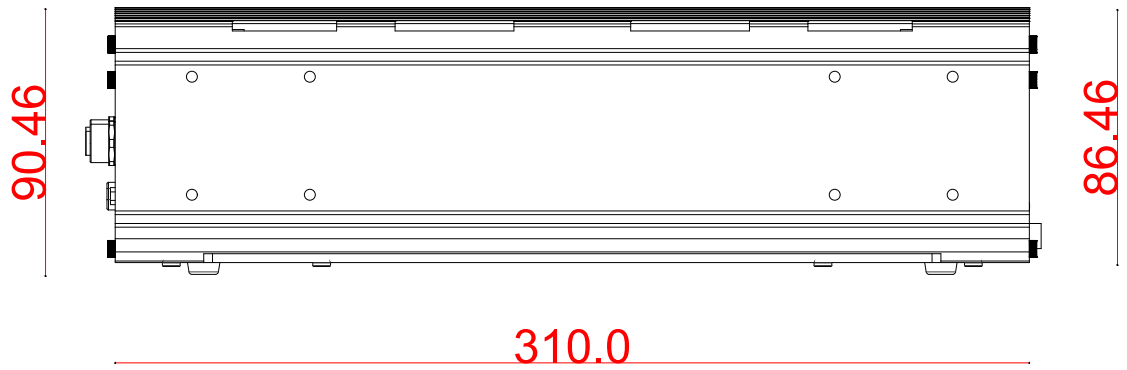

1.4.4 Bottom View

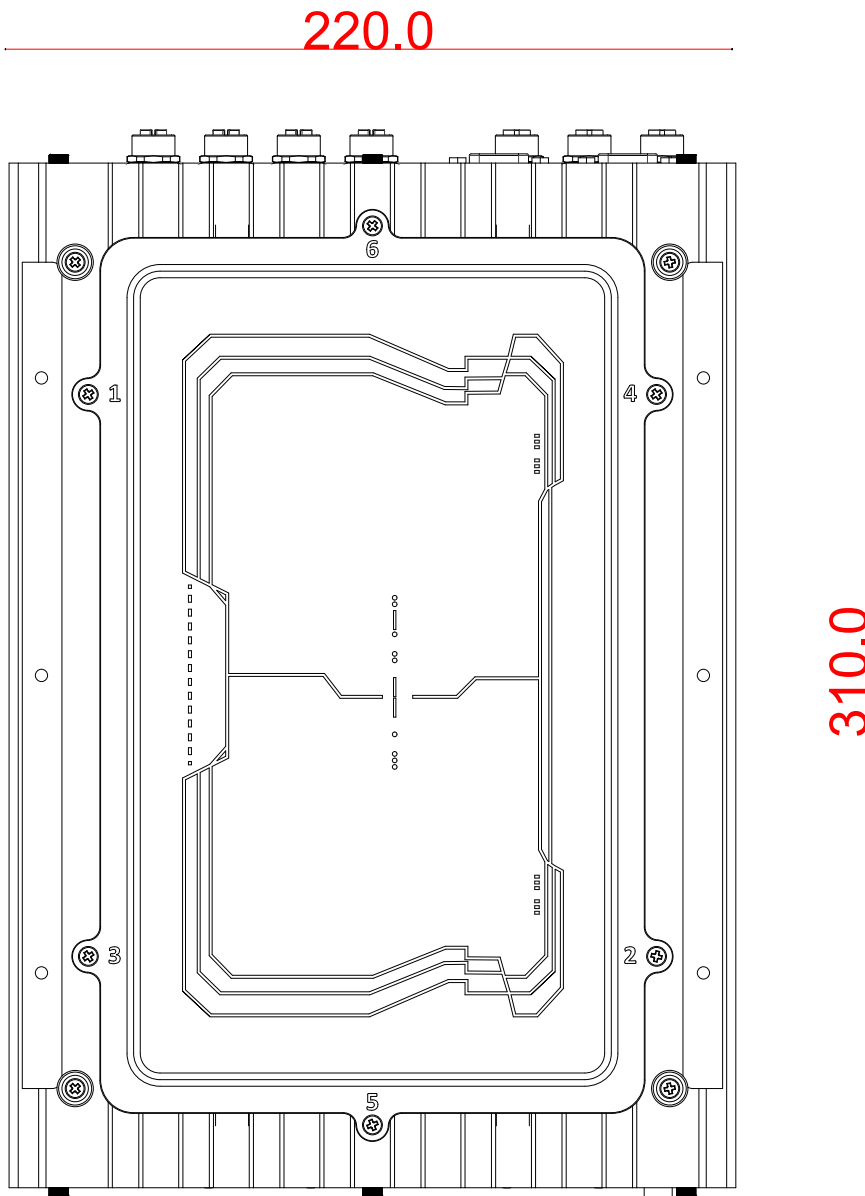

Antenna panel & opening measurements

1.5 Dimensions with Wall Mount Bracket



NOTE

All measurements are in millimeters (mm).

1.5.1 Front View

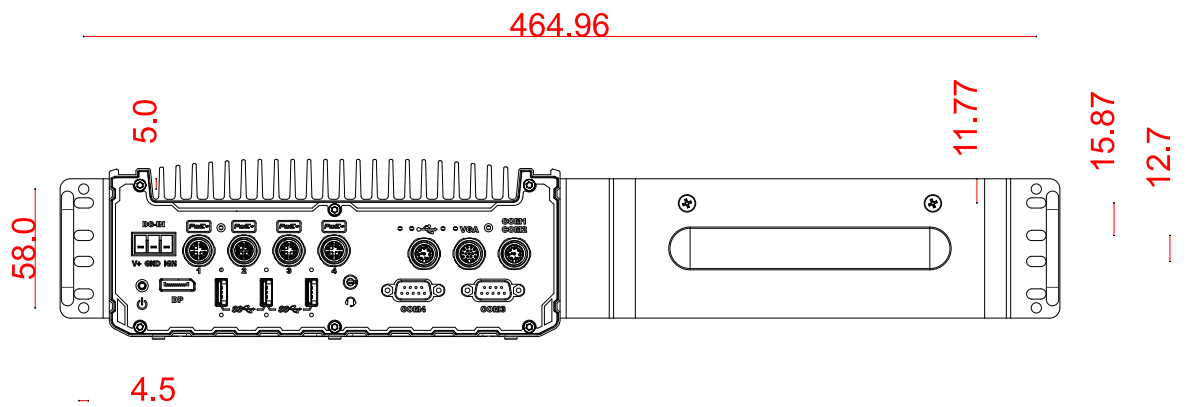

1.5.2 Bottom View

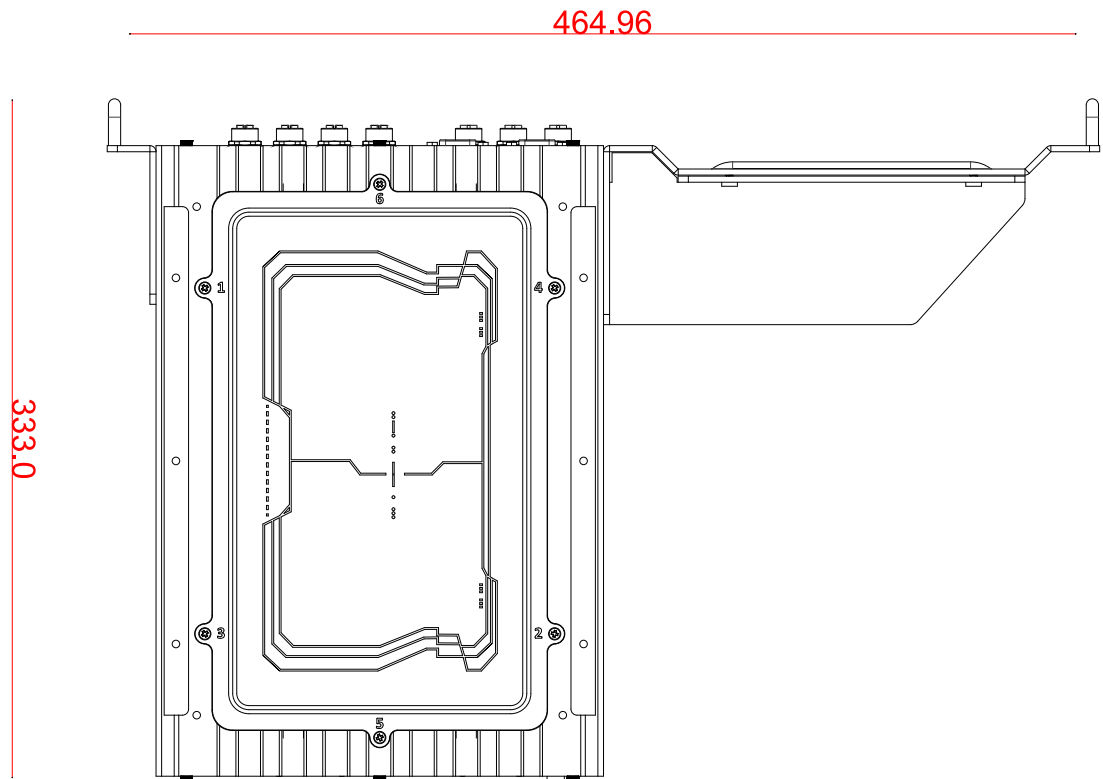

2 System Overview

Upon receiving and unpacking your system, please check immediately if the package contains all the items listed in the following table. If any item(s) are missing or damaged, please contact your local dealer or Neosys Technology.

2.1 SEMIL-1300 Packing List

System Pack	SEMIL-1300	Qty
1	SEMIL-1300 system (If you ordered graphics card/ CPU/ RAM/ HDD, please verify these items)	1
2	Accessory box, which contains Neosys Drivers & Utilities DVD Wall-mounting bracket	1 1 2

2.2 SEMIL-1300 Front Panel

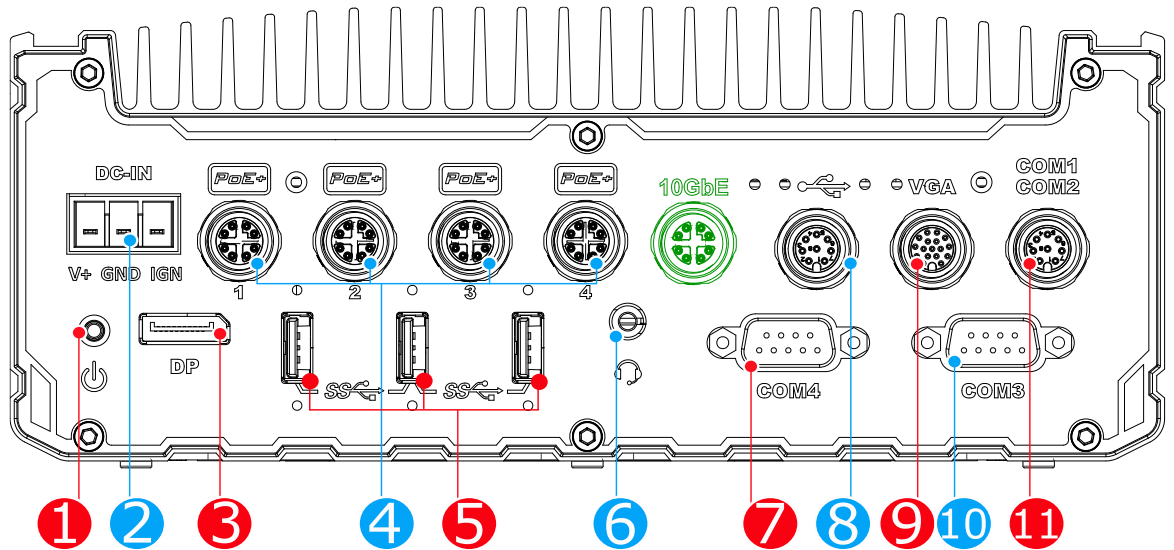

No.	Item	Description
1	Power button	Use this button to turn on or shutdown the system.
2	3-pin terminal block (DC/ ignition input)	Compatible with DC power input from 8~48V, the terminal block is also used for ignition signal input.
3	DisplayPort	Support display resolutions up to 4096 x 2304. Compatible with HDMI/ DVI via respective adapter cable (resolution may vary)
4	PoE+ GbE port	The M12 X-coded Power over Ethernet (PoE) ports provide both data connection and electric power to devices (eg. IP camera).
5	USB 3.1 Gen 1	USB3.1 Gen 1 offers up to 5Gbps of data-throughput performance
6	3.5mm 4-pole audio jack	The 4-pole 3.5mm jack accepts microphone voice input and headphone speaker sound output.
7	COM 4	A DB9 RS-232 COM port
8	USB 2.0	The M12 A-coded USB 2.0 port offers two USB 2.0 connection
9	VGA	VGA output supports resolution up to 1920x1200@60Hz
10	COM 3	A 3-wire DB9 software-programmable RS-232/ 422/ 485 port
11	COM 1 & 2	The M12 A-coded connector offers two RS-232 ports
	Optional 10Gb Ethernet	The optional 10GbE is backwards compatible with 5Gb, 2.5Gb, and GbE connections.

2.2.1 Power Button

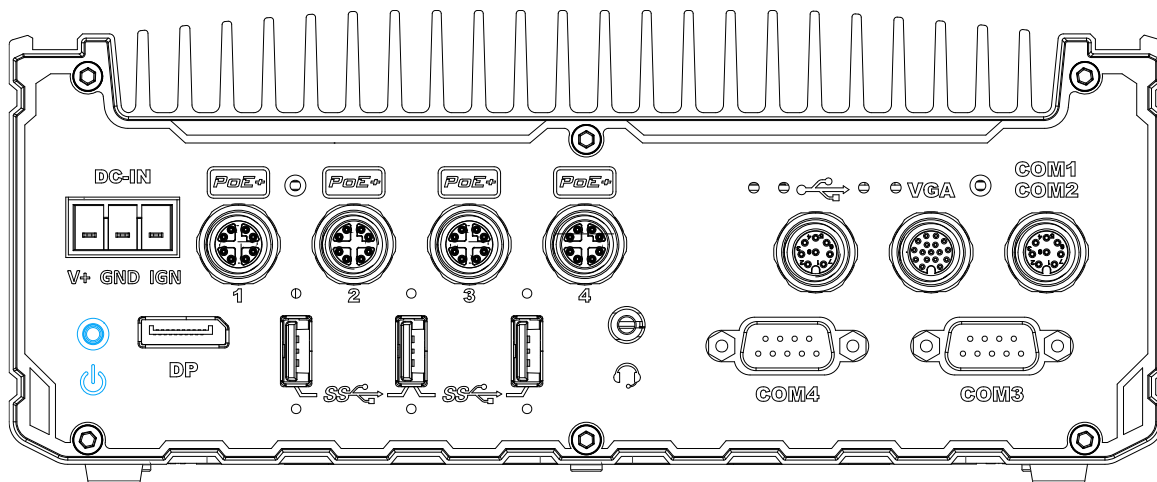

The power button is a non-latched switch for ATX mode on/off operation. To turn on the system, press the power button and the PWR LED should light-up green. To turn off the system, issuing a shutdown command in OS is preferred, or you can simply press the power button. To force shutdown when the system freezes, press and hold the power button for 5 seconds. Please note that there is a 5-second interval between on/off operations (i.e. once the system is turned off, there is a 5-second wait before you can power-on the system).

2.2.2 3-pin Terminal Block for DC and Ignition Input

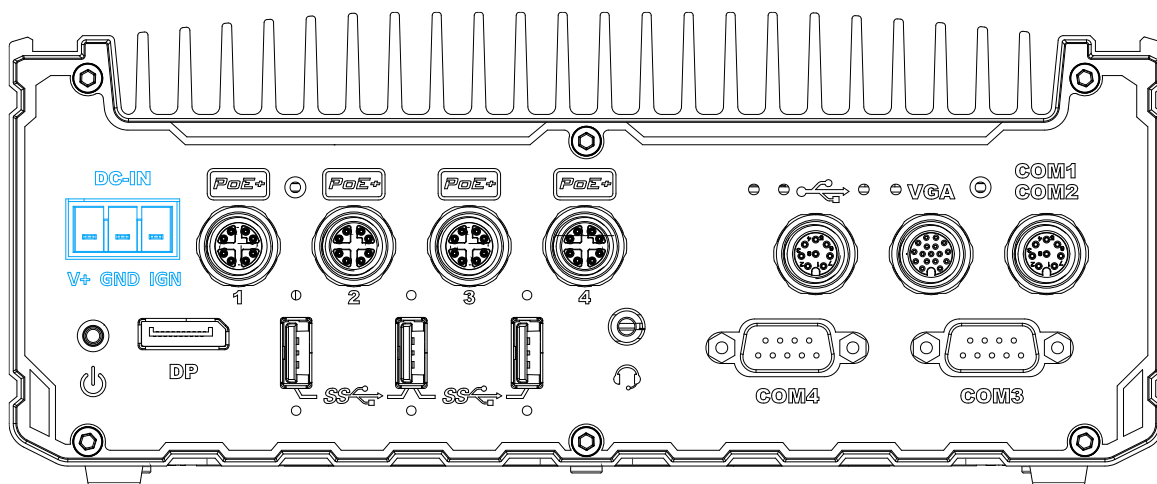

The system accepts a wide range of DC power input from 8 to 48V via a 3-pin pluggable terminal block, which is fit for field usage where DC power is usually provided. The terminal block can also accept ignition signal input (IGN) for in-vehicle applications.

WARNING

Please make sure the voltage of DC power is correct before you connect it to the system.
Supplying a voltage over 48V will damage the system.

2.2.3 DisplayPort

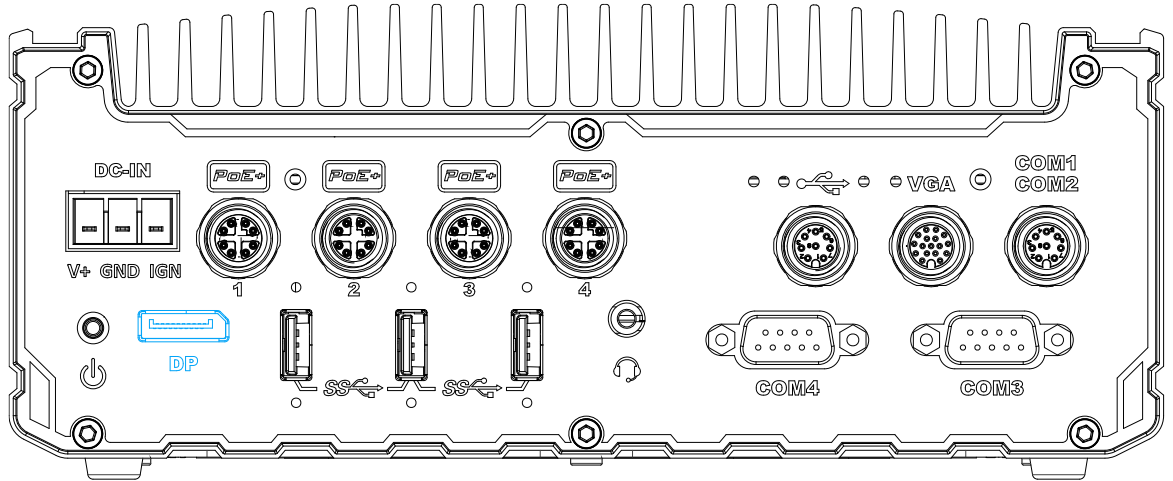

The system has a DisplayPort (DP) output which is a digital display interface that mainly connect video source and carry audio to a display device. When connecting a DisplayPort, it can deliver up to 4K UHD (4096 x 2304) in resolution. The system is designed to support passive DisplayPort adapter/ cable. You can connect to other display devices using DP-to-HDMI cable or DP-to-DVI cable.



DP-to-HDMI



DP-to-DVI

The system supports triple independent display outputs by connecting display devices to VGA, DVI and DisplayPort. To support multiple display outputs and achieve best DisplayPort output resolution in Windows, you need to install corresponding graphics drivers. Please refer to section [OS Support and Driver Installation](#) for details.

2.2.4 PoE+ Gigabit Ethernet Port

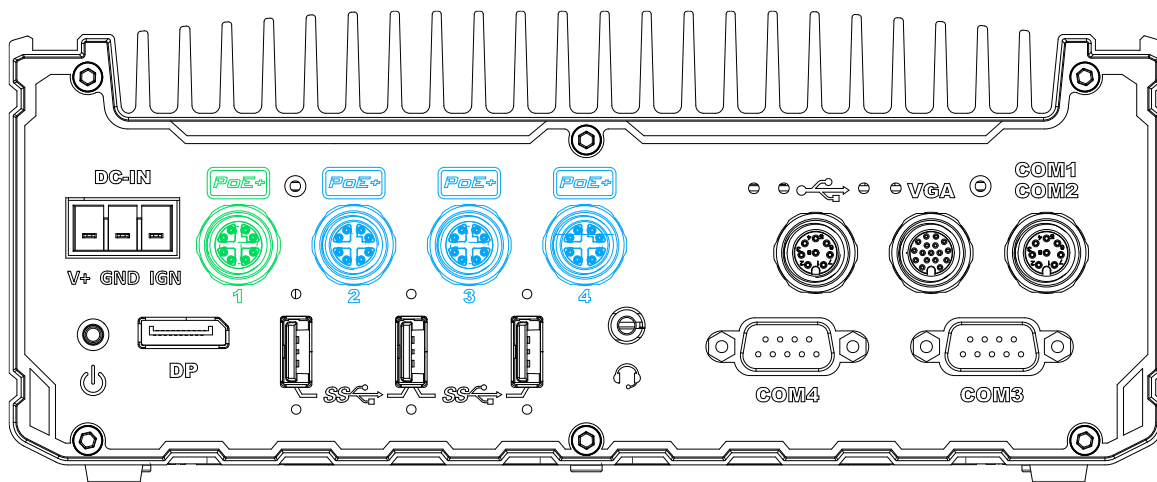

The system offers four PoE+ GbE ports via M12 X-coded connectors on the front panel. The port marked in **green** is implemented using Intel® I219-LM controller that supports Wake-on-LAN and is also compatible with [Intel® AMT \(Active Management Technology\)](#) to support advanced features such as remote SOL desktop and remote on/ off control. Power over Ethernet (PoE) supplies electrical power and data on a CAT-5/ CAT-6 Ethernet cable. Acting as a PoE PSE (Power Sourcing Equipment), compliant with IEEE 802.3at, each PoE port delivers up to 25.5W to a Powered Device (PD). PoE can automatically detect and determine if the connected device requires power or not, so it is compatible with standard Ethernet devices as well.

Each port has one dedicated PCI Express link for maximum network performance.

Connector Pin Definition

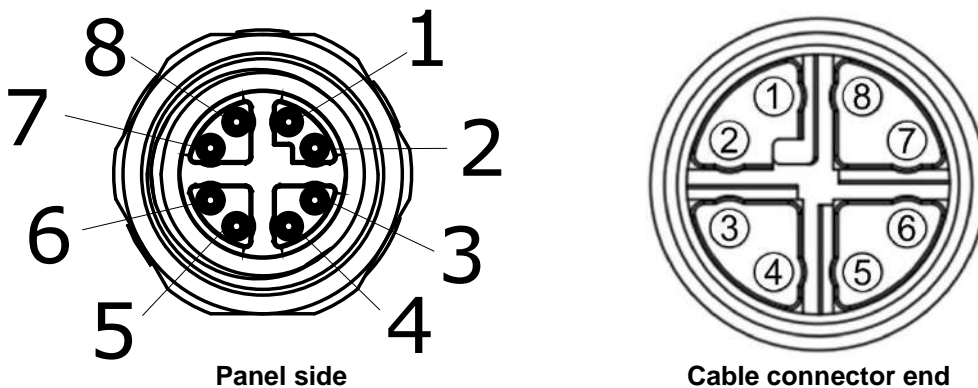

Signal	M12 panel side	M12 cable connector end	Wire color
LAN P0	1	1	Yellow
LAN N0	2	2	Yellow
LAN P1	3	3	Green
LAN N1	4	4	Green
LAN P3	5	5	Orange
LAN N3	6	6	Orange
LAN N2	7	7	Blue

LAN P2	8	8	
--------	---	---	--

2.2.5 USB3.1 Gen 1 Port

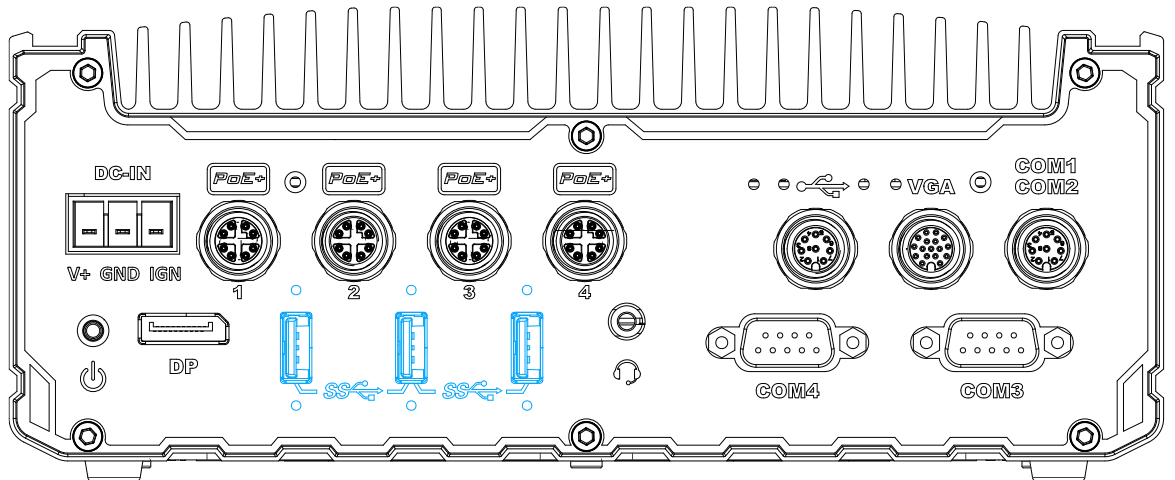

The system's USB 3.0 Gen 1 ports (5Gbps) come with screw-lock mechanisms and are implemented via native xHCI (eXtensible Host Controller Interface) controller. They are backward compatible with USB 2.0, USB 1.1 and USB 1.0 devices. Legacy USB is also supported so you can use USB keyboard/mouse in DOS environment

xHCI driver is supported natively in Windows 10, therefore you do not need to install xHCI driver in prior to utilize USB functions.

2.2.6 3.5mm 4-pole Audio Jack

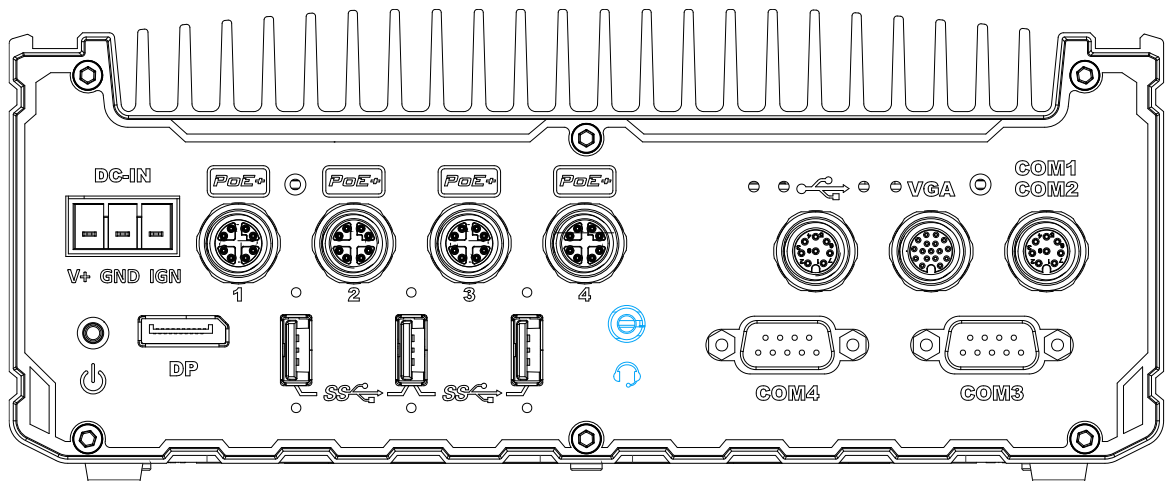

The system audio function uses high definition audio. There is a female 4-pole  audio jack for headphone (speaker) output and microphone input. To utilize the audio function in Windows, you need to install corresponding drivers for both motherboard chipset and audio.

2.2.7 COM Port 4

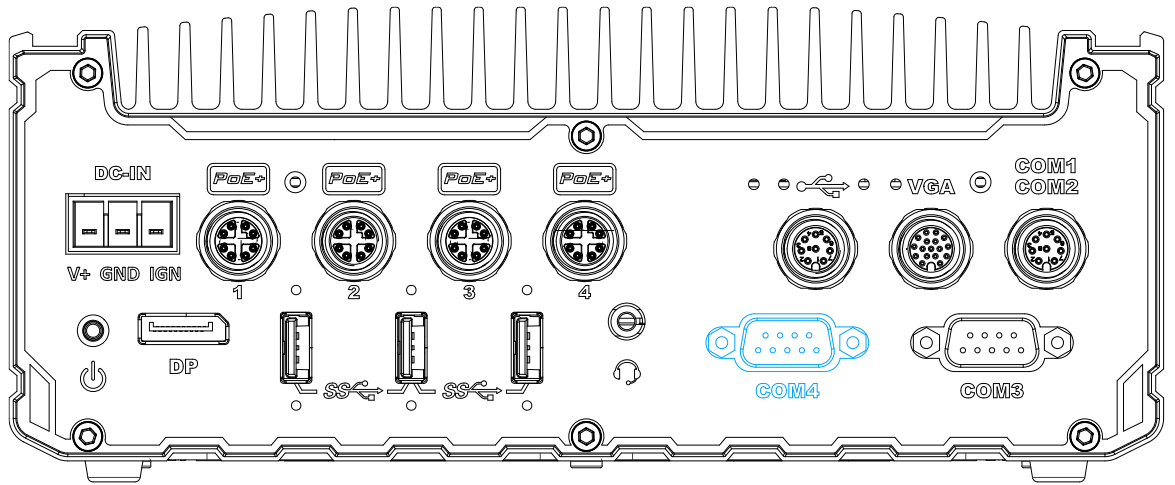

The COM 4 port is implemented using industrial-grade ITE8786 Super IO chip (-40 to 85°C) and provides up to 115200 bps baud rate.

COM Port Pin Definition

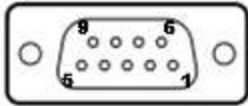

	COM4
Pin#	RS-232 Mode
1	DCD
2	RX
3	TX
4	DTR
5	GND
6	DSR
7	RTS
8	CTS
9	RI

2.2.8 USB2.0 Port

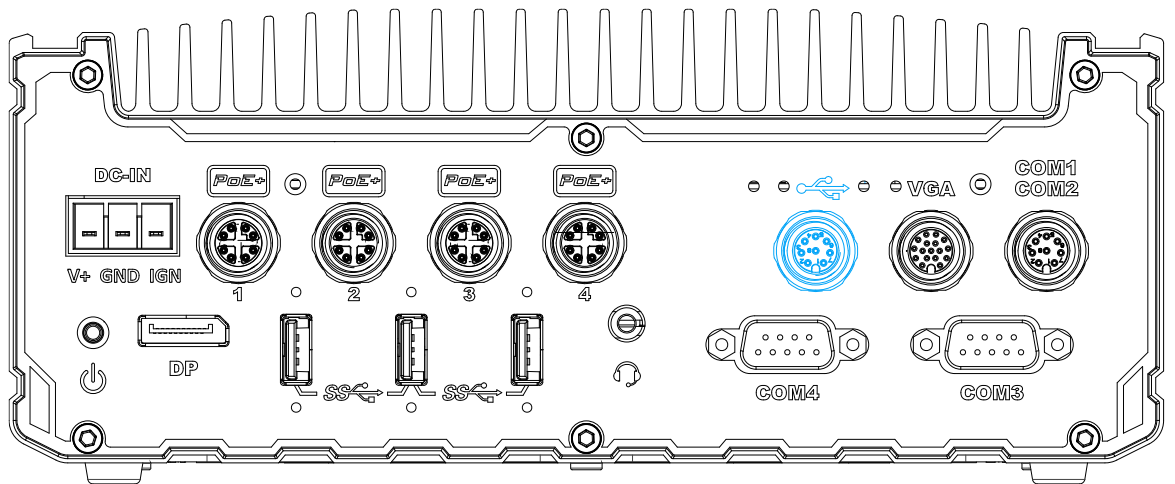

The M12 A-coded connector provides two USB2.0 connections and is implemented via native xHCI (eXtensible Host Controller Interface) controller. USB2.0 is backward compatible with USB 1.1 and USB 1.0 devices. Legacy USB support is also provided so you can use USB keyboard/ mouse in DOS environment.

Connector Pin Definition

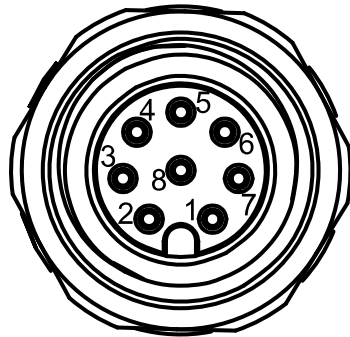

Panel side

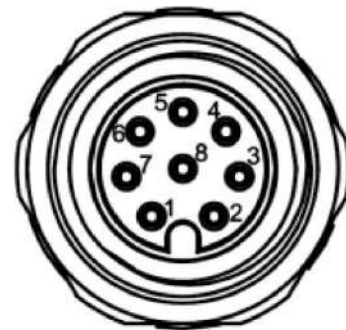

Cable connector end

Signal	M12 panel side	M12 cable connector end	Wire color
D1+	1	1	Green
D1-	2	2	White
VCC_USB	3	3	Red
GND	4	4	Black
GND	5	5	Black
VCC_USB	6	6	Red
D2-	7	7	White
D2+	8	8	Green



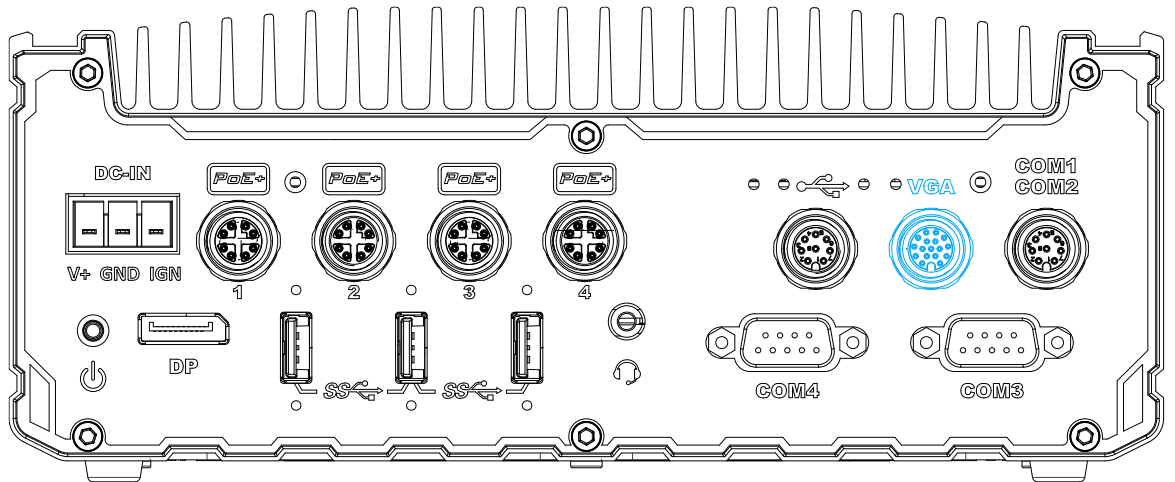





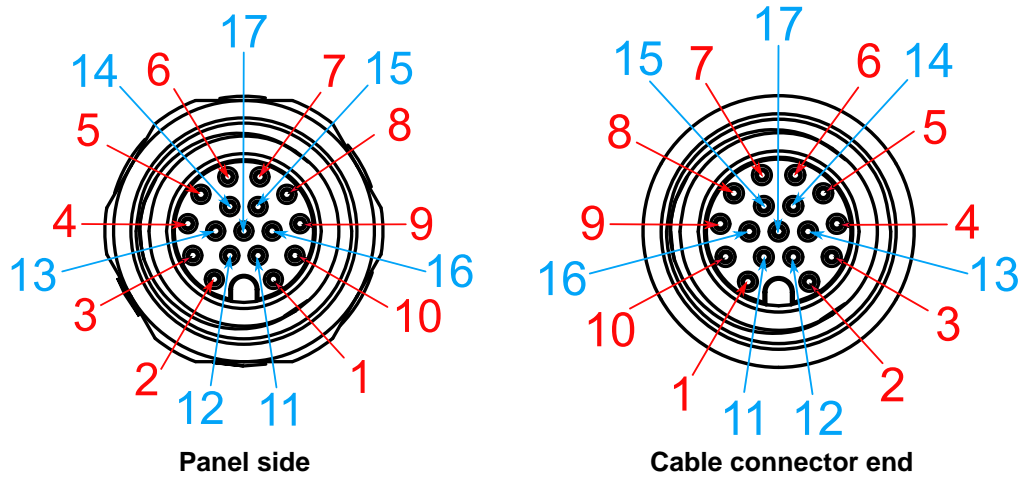

2.2.9 VGA Port

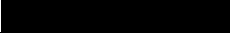

VGA connector is the most common video display connection. The VGA output supports up to 1920x1200@60Hz resolution. To support VGA display output and achieve best VGA output resolution in Windows, you need to install corresponding graphics drivers. Please refer to section [OS Support and Driver Installation](#) for details.

Connector Pin Definition



Signal	M12 panel side	M12 cable connector end	Wire color
Red	1	1	
GREEN	9	9	
BLUE	7	7	
GND	6	6	
GND	8	8	
GND	10	10	
GND	12	12	
GND	13	13	
GND	14	14	
GND	11	11	
GND	16	16	

GND	15	15		
P5V_VGA	17	17		
VGA_SDA	5	5		
HSYNC_CN	3	3		
VSYNC_CN	2	2		
VGA_SCL	4	4		



NOTE

Please make sure your VGA cable includes SDA and SCL (DDC clock and data) signals for correct communication with monitor to get resolution/timing information. A cable without SDA/ SCL can cause blank screen on your VGA monitor due to incorrect resolution/timing output.

2.2.10 COM Port 3

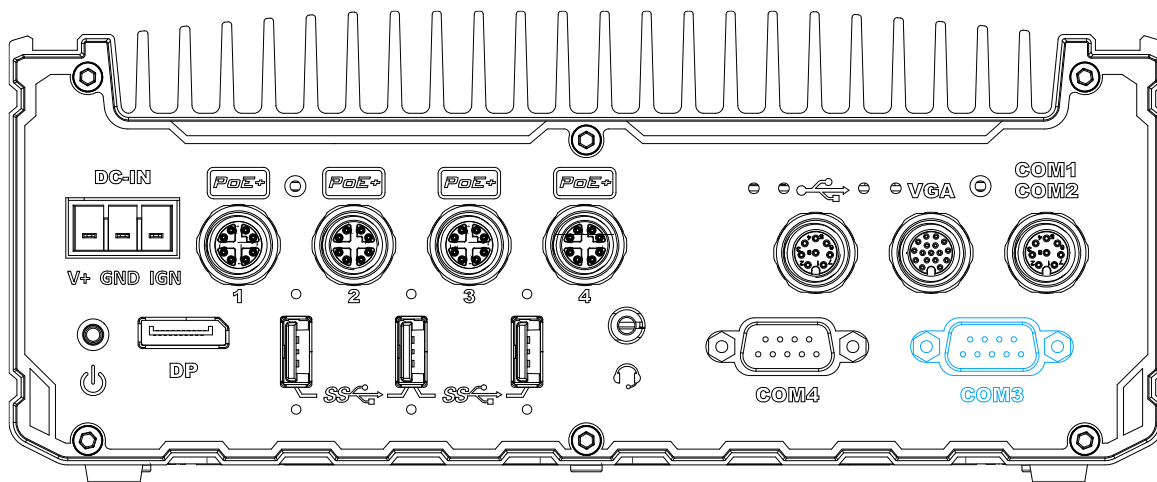

COM port 3 is implemented using industrial-grade ITE8786 Super IO chip (-40 to 85°C) and provide up to 115200 bps baud rate to communicate with external devices.

COM3 is a software-configurable RS-232/422/485 port. The operation mode can be set in BIOS setup utility. The following table describes the pin definition of the COM port.

COM Port Pin Definition

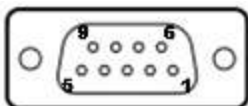

COM3			
Pin#	RS-232 Mode	RS-422 Mode	RS-485 Mode (Two-wire 485)
1	DCD		
2	RX	422 TXD+	485 TXD+/RXD+
3	TX	422 RXD+	
4	DTR	422 RXD-	
5	GND	GND	GND
6	DSR		
7	RTS		
8	CTS	422 TXD-	485 TXD-/RXD-
9	RI		

2.2.11 COM1/ COM2 Port

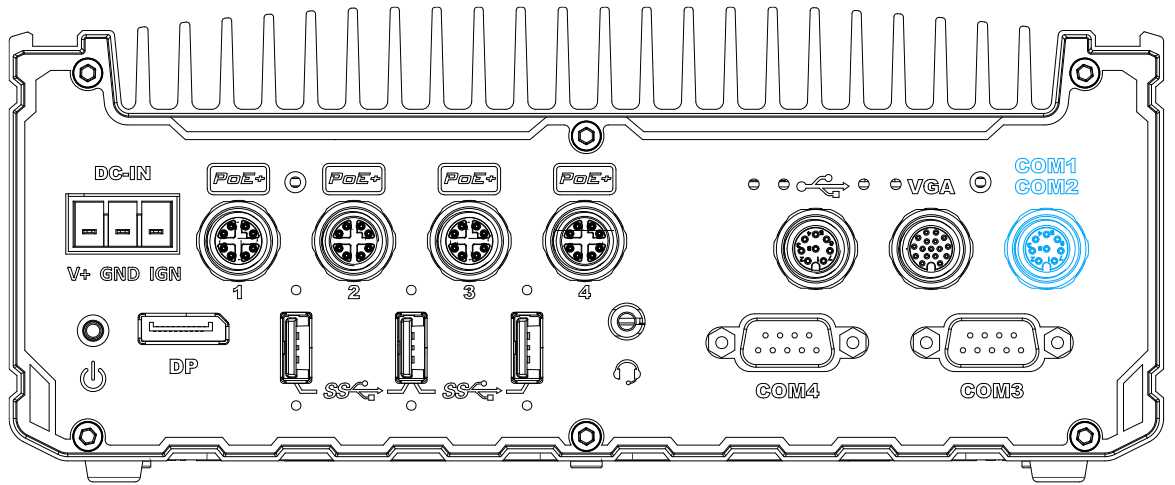

The system provides COM1 and COM2 ports via an M12 A-coded connector for communicating with external devices. These COM ports are 3-wire RS-232 specifications and provide up to 115200 bps baud rate.



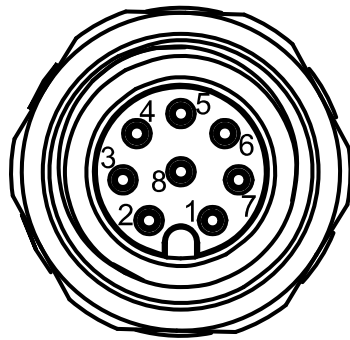

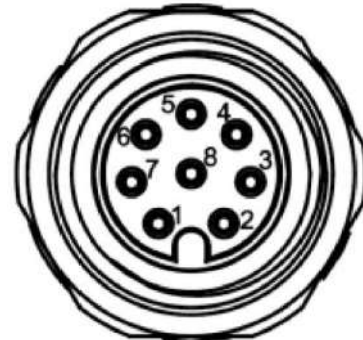

Connector Pin Definition



Panel side

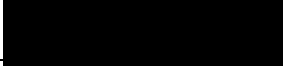

Cable connector end

Signal	M12 panel side	M12 cable connector end	Wire color
TXD1	1	1	
RXD1	2	2	
GND	3	3	
PWR_IGN	4	4	
GND	5	5	
GND	6	6	
RXD2	7	7	

TXD2	8	8	
------	---	---	--

2.2.12 Optional 10Gb Ethernet

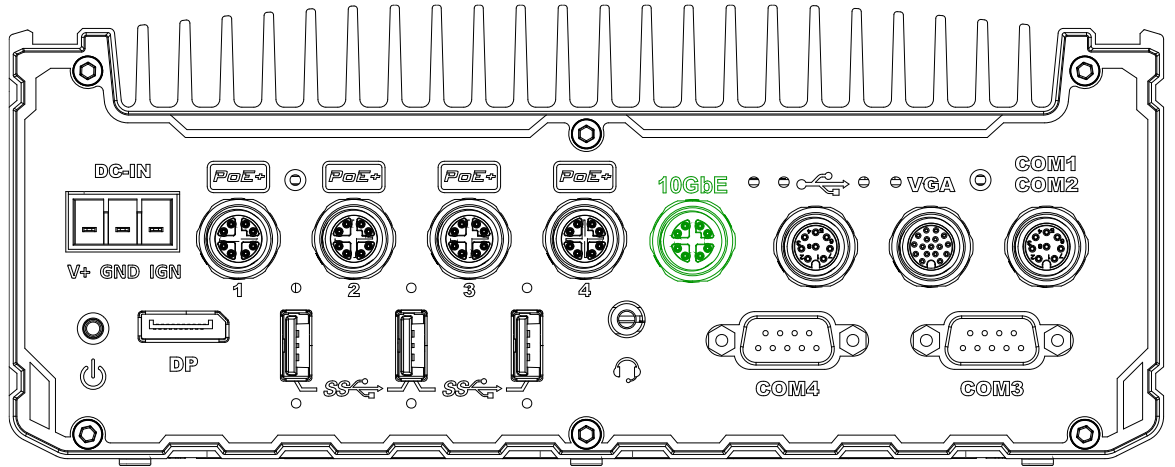

The system offers an optional 10Gb Ethernet via M12 X-coded connector (in green) implemented using Intel® X550AT controller on the front panel. The port is backwards compatible with 5Gb, 2.5Gb, and Gb Ethernet connections.

Connector Pin Definition

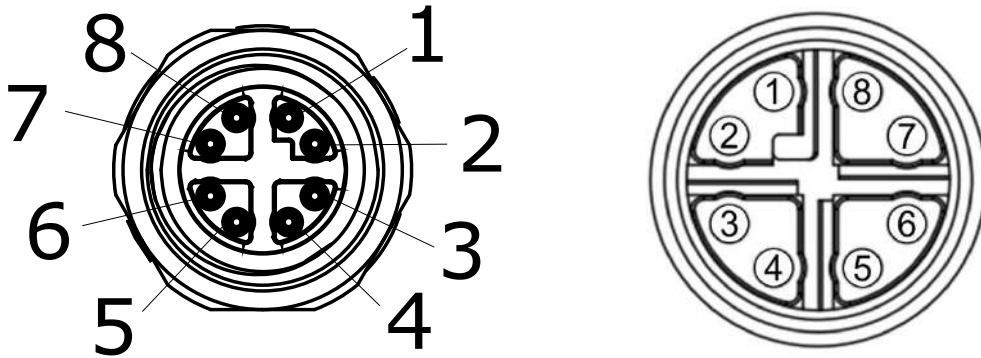

Signal	M12 panel side	M12 cable connector end	Wire color
LAN P0	1	1	Yellow
LAN N0	2	2	Yellow
LAN P1	3	3	Green
LAN N1	4	4	Green
LAN P3	5	5	Orange
LAN N3	6	6	Orange
LAN N2	7	7	Blue
LAN P2	8	8	Blue

2.3 Internal I/Os

In addition to connectors on the enclosure panel, the system also provides internal expansion slots such as for hard drives, mini-PCIe, M.2 modules and access to ignition control rotary switch.

2.3.1 M.2 3042/ 3052 B Key Module Expansion Slot & Corresponding SIM Slots



The system has an M.2 3042/ 3052 slot (indicated in **blue rectangle**) with dual SIM slots (indicated in **red rectangle**) supporting 5G/ 4G. A copper standoff is provided for you to secure onto the motherboard into the **red arrow** location for an M.2 3042 module, or into the **blue arrow** location for an M.2 3052 module. By installing a 5G or 4G M.2 module and SIM card, you can access the internet via the provider's network.

For wireless 5G/ 4G, SMA antenna apertures are located at the rear of the enclosure.

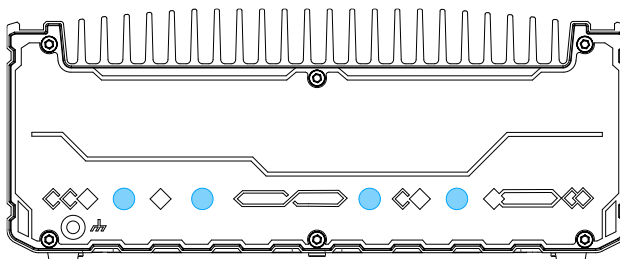

M.2 (B Key) Slot Pin Definition

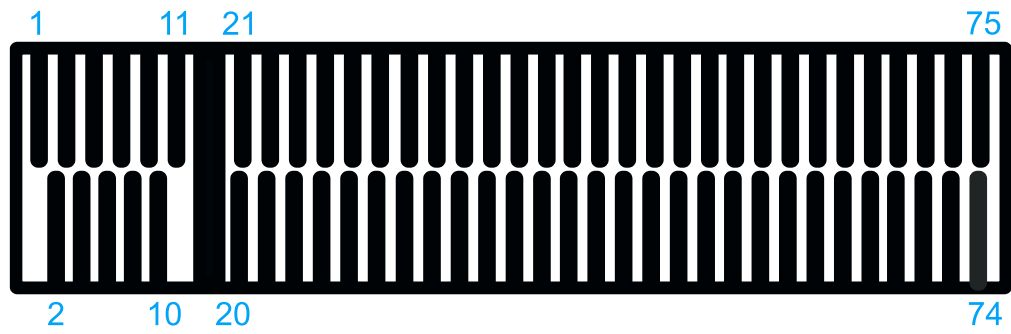

Pin #	Signal	Pin #	Signal
1	-	2	+3V3
3	GND	4	+3V3
5	GND	6	FULL_CARD_POWER_OFF_N
7	USB_D+	8	W_DISABLE_N
9	USB_D-	10	-
11	GND		
Mechanical Key			
21	-	20	-
23	-	22	-
25	-	24	-
27	GND	26	-
29	USB3.0-RX-	28	-
31	USB3.0-RX+	30	UIM1-RESET
33	GND	32	UIM1-CLK
35	USB3.0-TX-	34	UIM1-DATA
37	USB3.0-TX+	36	UIM1-PWR
39	GND	38	-
41	PERn0 / SATA-B+	40	UIM2-DET
43	PERp0 / SATA-B-	42	UIM2-DATA
45	GND	44	UIM2-CLK
47	PETn0 / SATA-A-	46	UIM2-RST
49	PETp0 / SATA-A+	48	UIM2-PWR
51	GND	50	PERST_N
53	REFCLKN	52	-
55	REFCLKP	54	-
57	GND	56	-
59	-	58	-
61	-	60	-
63	-	62	-
65	-	64	-
67	RESET_N	66	UIM1_DETECT
69	CONFIG_1	68	-
71	GND	70	+3V3
73	GND	72	+3V3
75	-	74	+3V3

2.3.2 M.2 2242 E Key Module Expansion Slot



The system has an M.2 2230 E key socket for WiFi module installation.

For SMA antenna installation, there are openings located at the rear of the chassis.

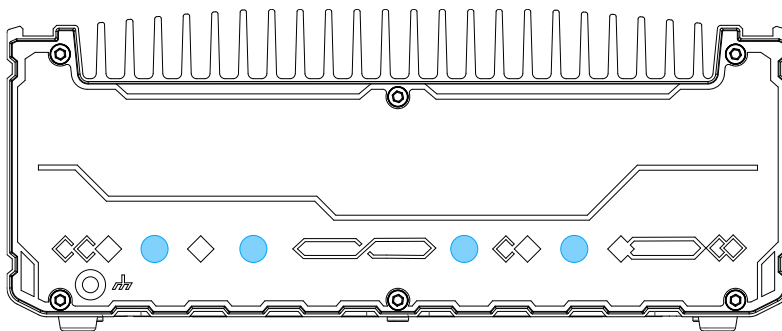

M.2 2230 E Key Pin Definition

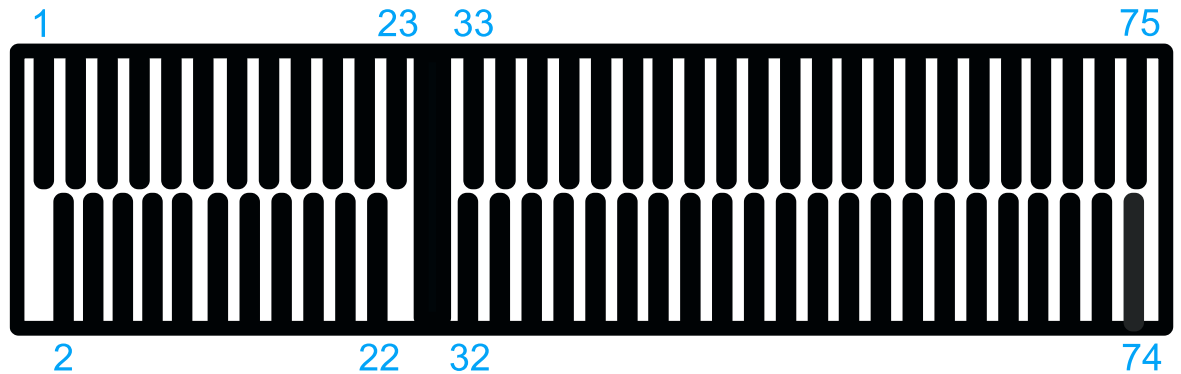

Pin #	Signal	Pin #	Signal
1	GND	2	+3V3
3	USB_D+	4	+3V3
5	USB_D-	6	
7	GND	8	
9		10	-
11		12	
13		14	
15		16	
17		18	GND
19		20	
21	-	22	-
23	-		
Mechanical Key			
33	GND	32	
35	PETP0	34	
37	PETN0	36	
39	GND	38	
41	PER P0	40	
43	PER N0	42	
45	GND	44	
47	REFCLK_P0	46	
49	REFCLK_N0	48	
51	GND	50	
53	CLKREQ#	52	PERST#
55		54	
57	GND	56	W_DISABLE#
59		58	
61		60	
63	GND	62	
65		64	
67		66	
69	GND	68	
71		70	
73		72	+3V3

75	GND	74	+3V3
----	-----	----	------

2.3.3 mini-PCIe Expansion Slot (mux with mSATA)



The system has two mini-PCIe sockets mux with mSATA and there are plenty of off-the-shelf mini-PCIe modules with versatile capabilities. By installing a mini-PCIe module, your system can have expanded features such as 5G/4G, WIFI, GPS, CAN bus, analog frame grabber, etc.

For SMA antenna installation, there are dedicated openings at the rear of the chassis.

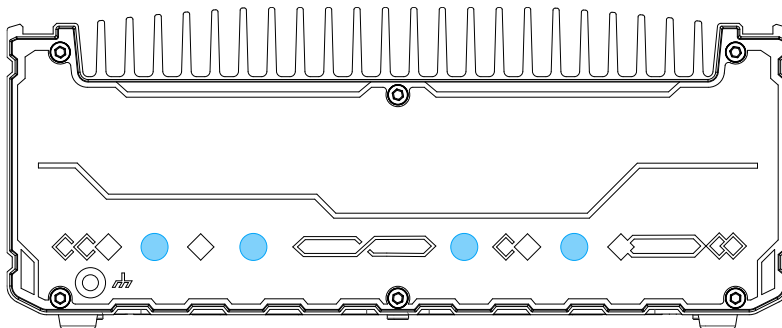

mini-PCle slot definition

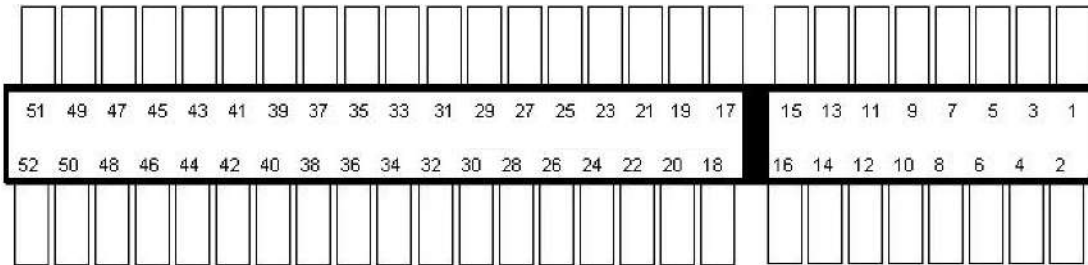

Pin #	Signal	Pin #	Signal
1	WAKE#	2	+3.3Vaux
3	COEX1	4	GND
5	COEX2	6	+1.5V
7	CLKREQ#	8	UIM_PWR
9	GND	10	UIM_DATA
11	REFCLK-	12	UIM_CLK
13	REFCLK+	14	UIM_RESET
15	GND	16	UIM_VPP
Mechanical Key			
17	Reserved* (UIM_C8)	18	GND
19	Reserved* (UIM_C4)	20	W_DISABLE#
21	GND	22	PERST#
23	PERn0	24	+3.3Vaux
25	PERp0	26	GND
27	GND	28	+1.5V
29	GND	30	SMB_CLK
31	PETn0	32	SMB_DATA
33	PETp0	34	GND
35	GND	36	USB_D-
37	GND	38	USB_D+
39	+3.3Vaux	40	GND
41	+3.3Vaux	42	LED_WWAN#
43	GND	44	LED_WLAN#
45	Reserved	46	LED_WPAN#
47	Reserved	48	+1.5V
49	Reserved	50	GND
51	Reserved	52	+3.3Vaux

2.3.4 Ignition Control Rotary Switch



The ignition power control switch features multiple modes for pre and post ignition settings. Please refer to the section [Ignition Power Control](#) for details.

3 Installation

3.1 M.2 Module & SIM card Installation

The system comes with an E key M.2 2242/ 2252 and an B key M.2 3042/ 3052 expansion slot. To install or replace M.2 modules in the system, please refer to the following instructions:

1. Disconnect all cable connections and shut down the system.
2. Turn the system upside-down and place it on a flat sturdy surface.
3. Unscrew the indicated screws in descending order.

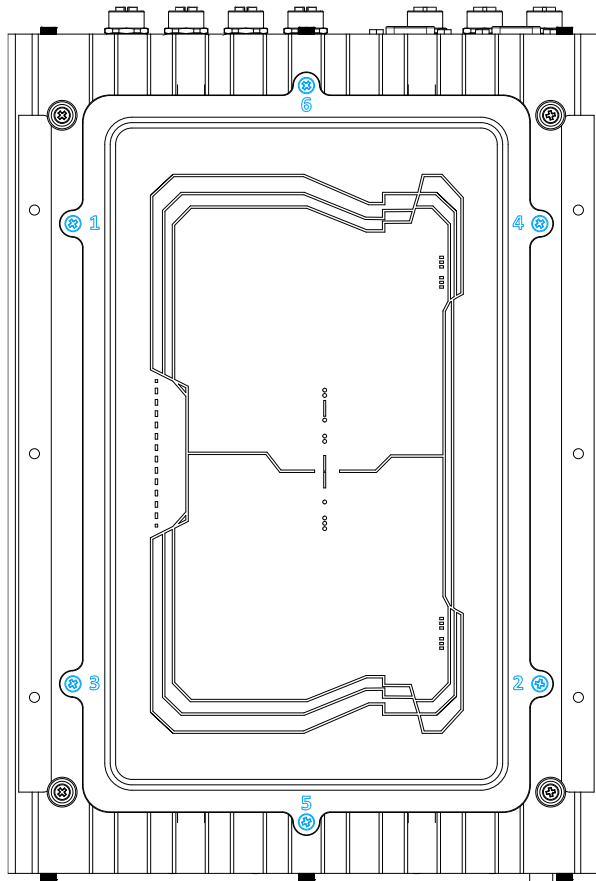

- Gently lift the panel and you will see the internal components.

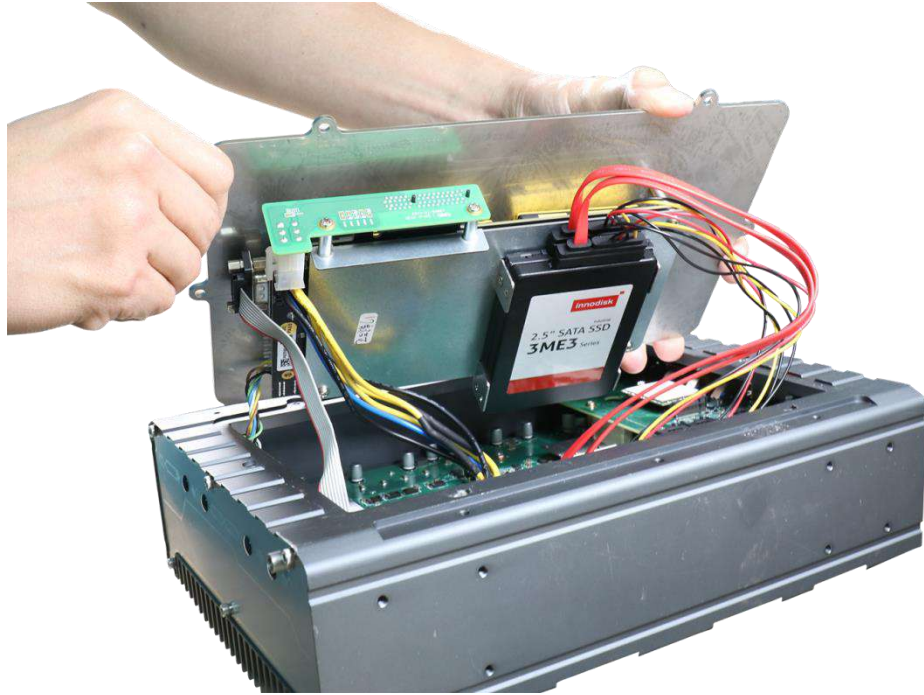

- It is recommended that you disconnect the cables to better access and install components.

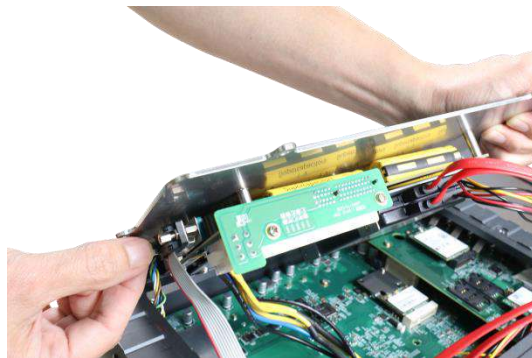

Unplug the DB9 connection to the PB unit

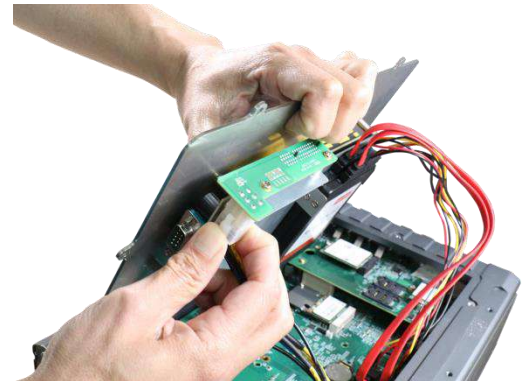

Unplug the 4-pin ATX connector



Disconnect the 4-pin power connector



Disconnect from the motherboard side

6. If hard drives are installed, disconnect the SATA/ power connector. Pull using the connector body, **DO NOT** pull on the cable!

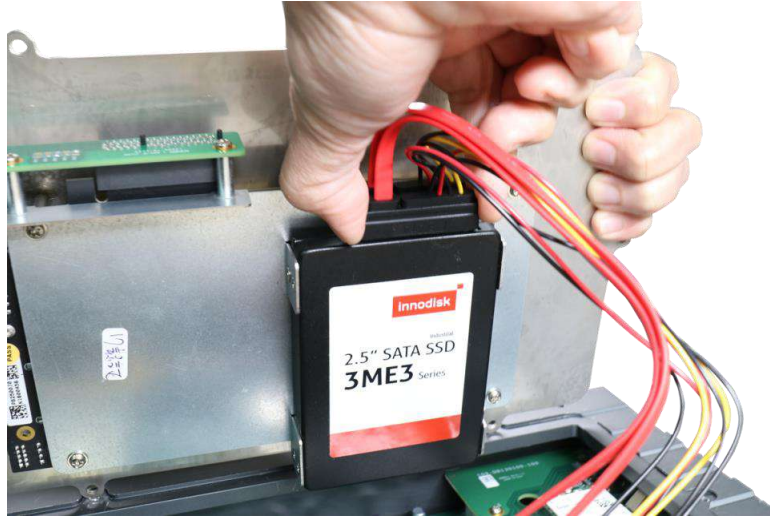

7. Identify the slot locations of the M.2 slots.



The **red rectangle** is an M.2 2242 slot, **blue rectangle** is an M.2 3042/ 3052 slot, the two **green rectangles** are SIM card slots accessible by the module installed into the M.2 3042/ 3052 slot, the **red arrow** indicates the position for installing an M.2 3042 module's copper standoff, and the **blue arrow** indicates the position for installing an M.2 3052 module's copper standoff.

8. To install an M.2 module, simply insert the module into the slot on a 45 degree angle, press down and secure with a screw.



Insert into slot on a 45 degree angle



Secure the module with a screw

9. Refer to the module's manual and connect the antenna (IPEX-to-SMA cable).
10. Remove an antenna hole on the enclosure and secure the antenna connector body.

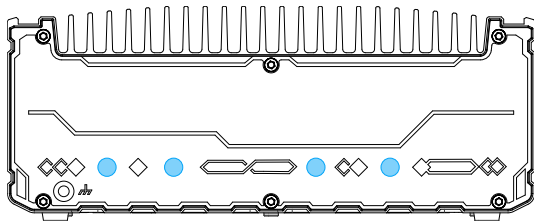

Antenna holes on enclosure

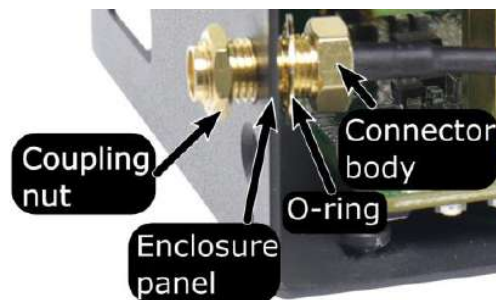

Secure the connector body, coupling nut onto a antenna opening on the enclosure panel

11. Insert the corresponding SIM card before you install the mini-PCIe module.

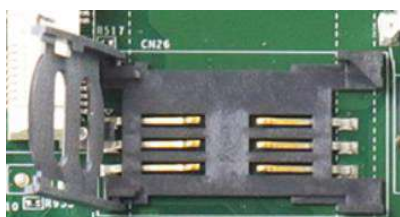

Slide and lift SIM card holder



Insert SIM card with pins facing up



Secure the SIM card by sliding the holder

12. Reconnect the cables for the PB module.

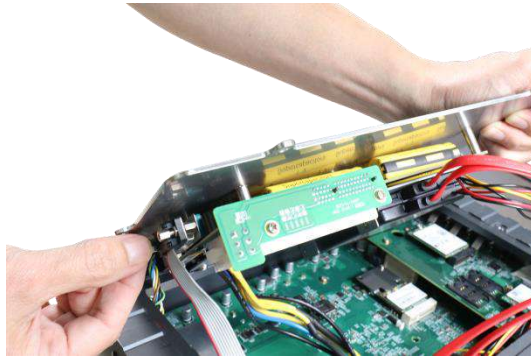

Connect the DB9 connection

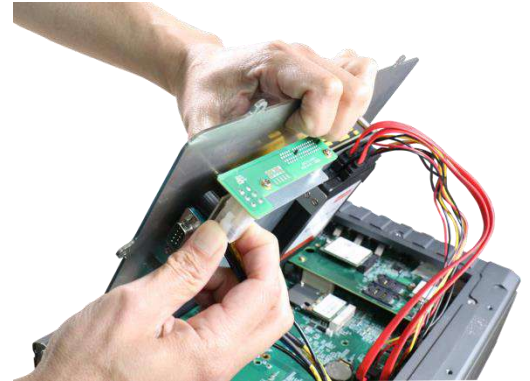

Plug in the 4-pin ATX connector



Connect the 4-pin power connector



Connect from the motherboard side

13. Gently tug all the cables into the enclosure and shut the bottom panel back on.

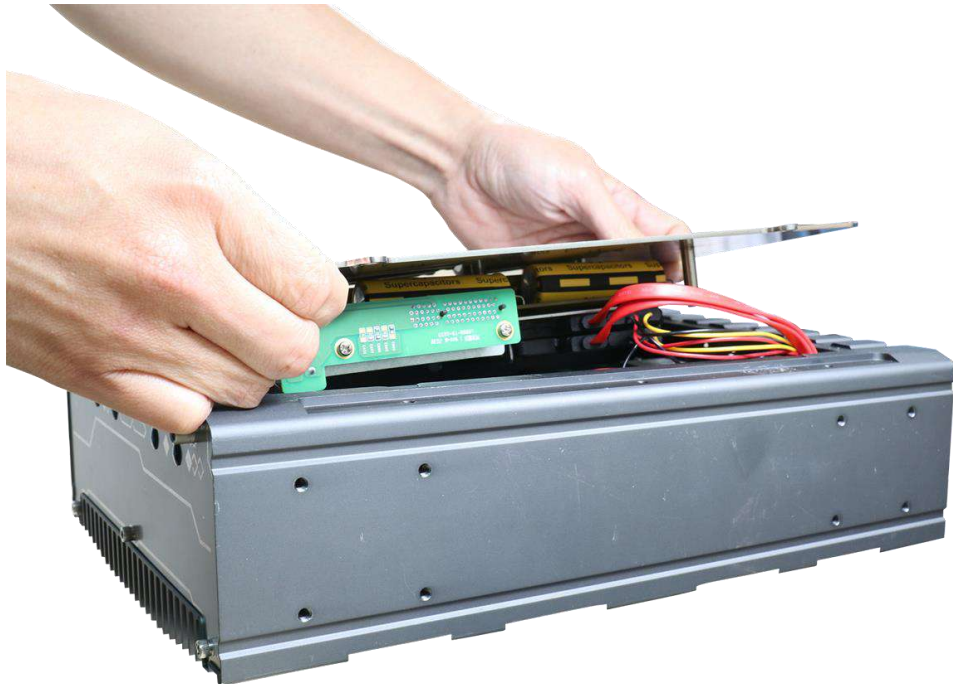

3.2 mini-PCIe Module Installation

To install or replace mini-PCIe modules in the system, please refer to the following instructions:

1. Disconnect all cable connections and shut down the system.
2. Turn the system upside-down and place it on a flat sturdy surface.
3. Unscrew the indicated screws in descending order.

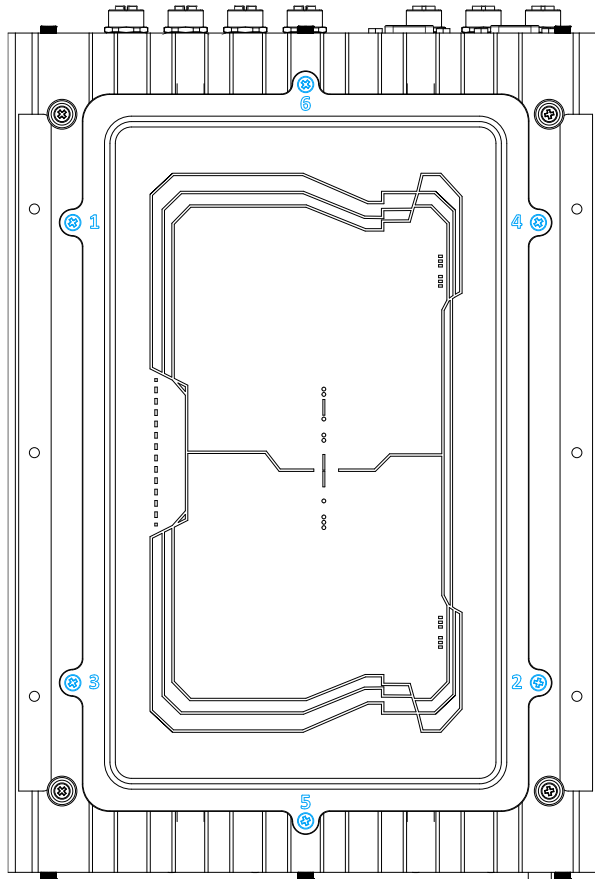

4. Gently lift the panel and you will see the internal components.

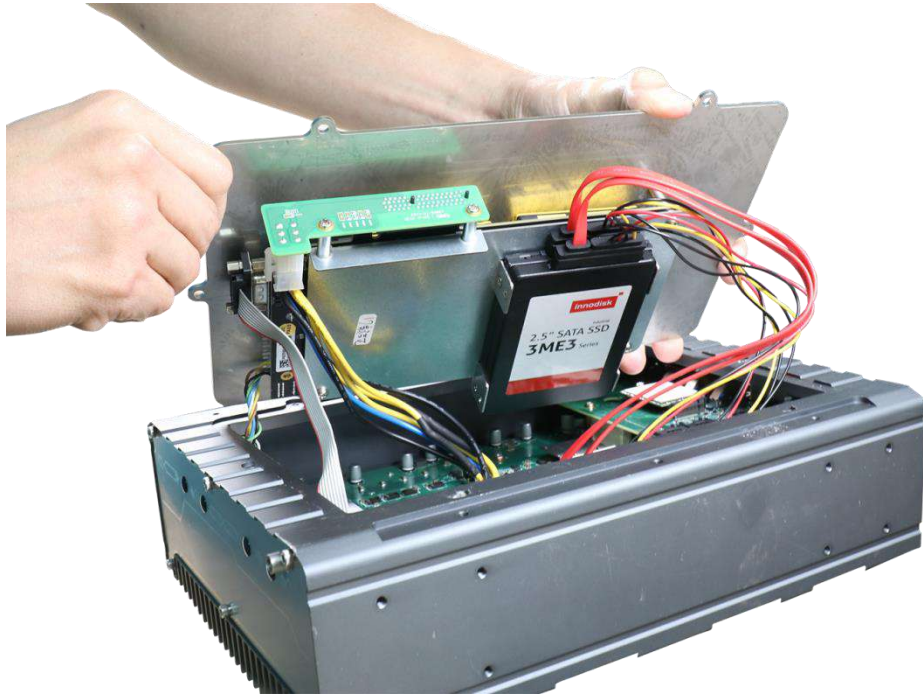

5. It is recommended that you disconnect the cables to better access and install components.

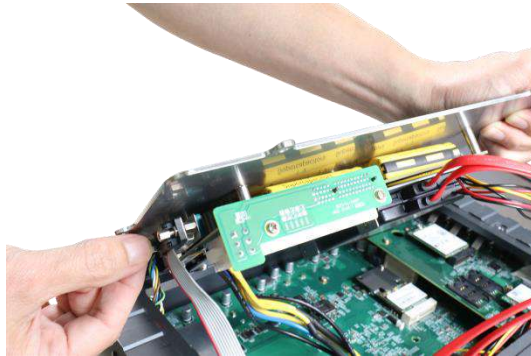

Unplug the DB9 connection to the PB unit

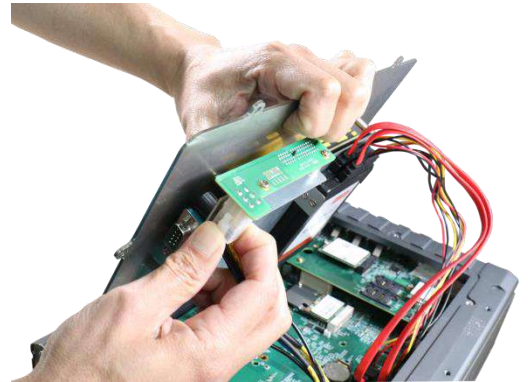

Unplug the 4-pin ATX connector



Disconnect the 4-pin power connector **Disconnect from the motherboard side**

6. If hard drives are installed, disconnect the SATA/ power connector. Pull using the connector body, **DO NOT** pull on the cable!

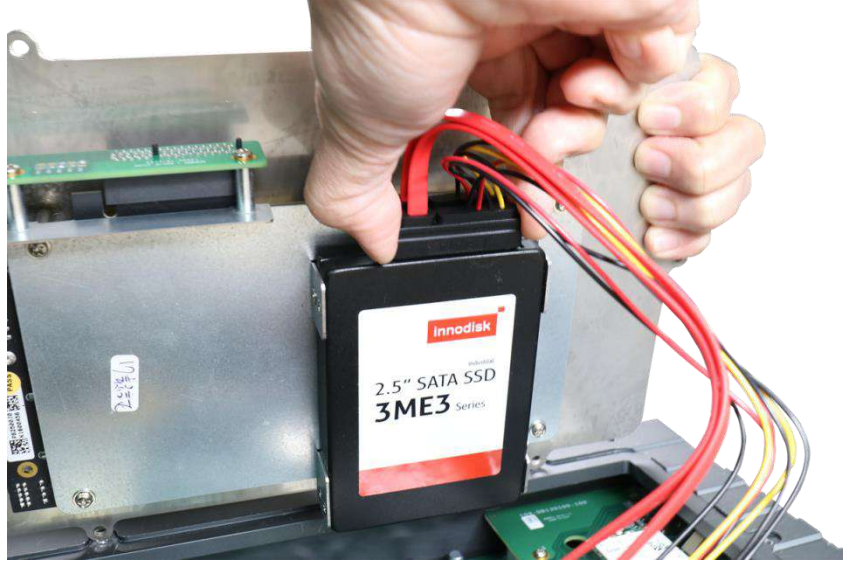

7. Identify the slot locations of the mini-PCIe/ M.2 slots and their respective SIM slots.



8. If you are installing 5G/ 4G mini-PCle modules, please install the respective SIM cards first.

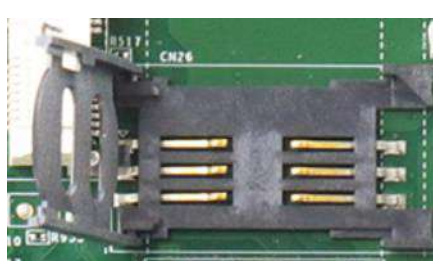

Slide and lift SIM card holder



Insert SIM card with pins facing up



Secure the SIM card by sliding the holder

9. To install mini-PCIe/ M.2 module, simply insert the module into the slot on a 45 degree angle, press down and secure with a screw.



Insert into slot on a 45 degree angle



Secure the module with a screw

10. Refer to the module's manual and connect the antenna.



11. Remove an antenna hole on the enclosure and secure the antenna connector body.

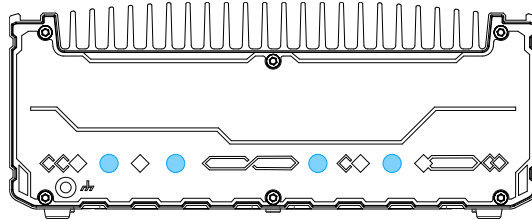

Antenna holes on enclosure

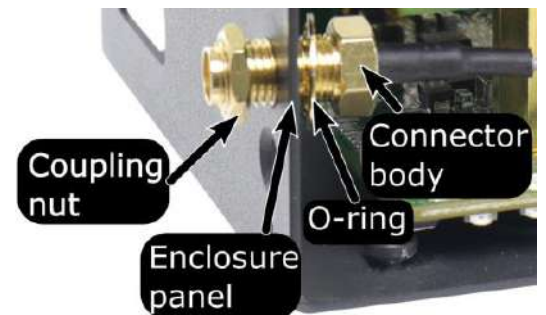

Secure the connector body, coupling nut onto a antenna opening on the enclosure panel

12. Reconnect the cables for the PB module.

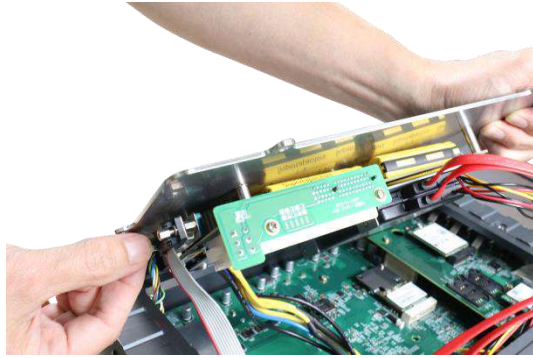

Connect the DB9 connection

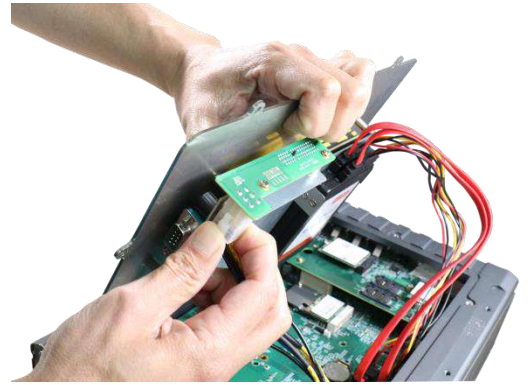

Plug in the 4-pin ATX connector



Connect the 4-pin power connector



Connect from the motherboard side

13. Gently tug all the cables into the enclosure and shut the bottom panel back on.

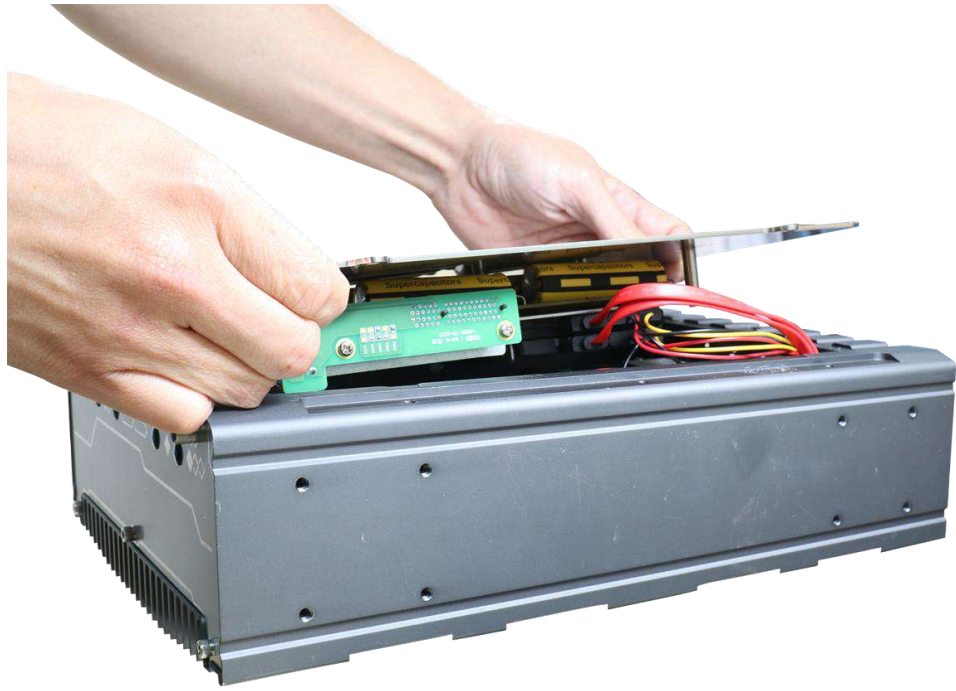

14. Secure the indicated screws in ascending order to complete the HDD installation procedure.

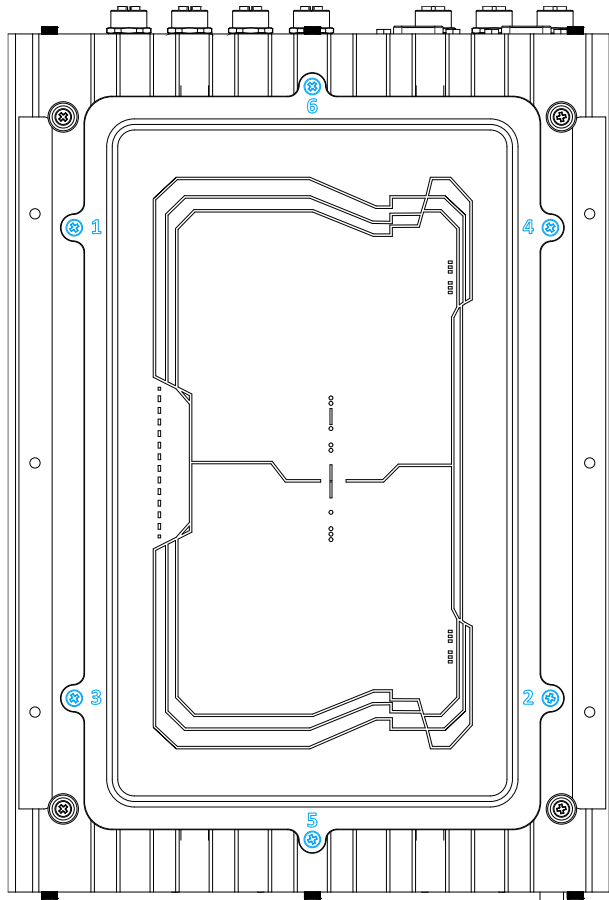

3.3 Hard Drive Installation

To install or replace hard drives in the system, please refer to the following instructions:

1. Disconnect all cable connections and shut down the system.
2. Turn the system upside-down and place it on a flat sturdy surface.
3. Unscrew the indicated screws in descending order.

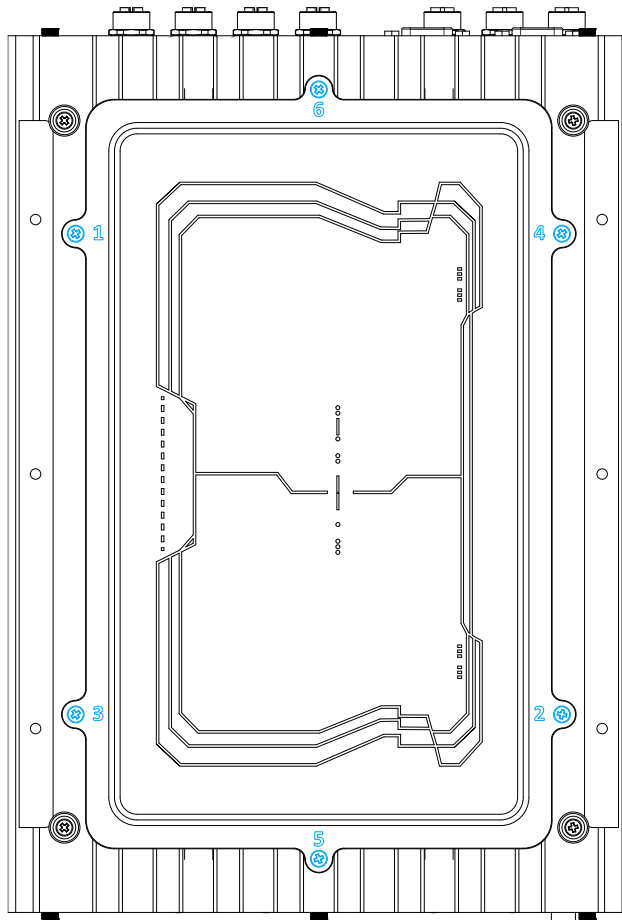

4. Gently lift the panel and you will see the internal components.

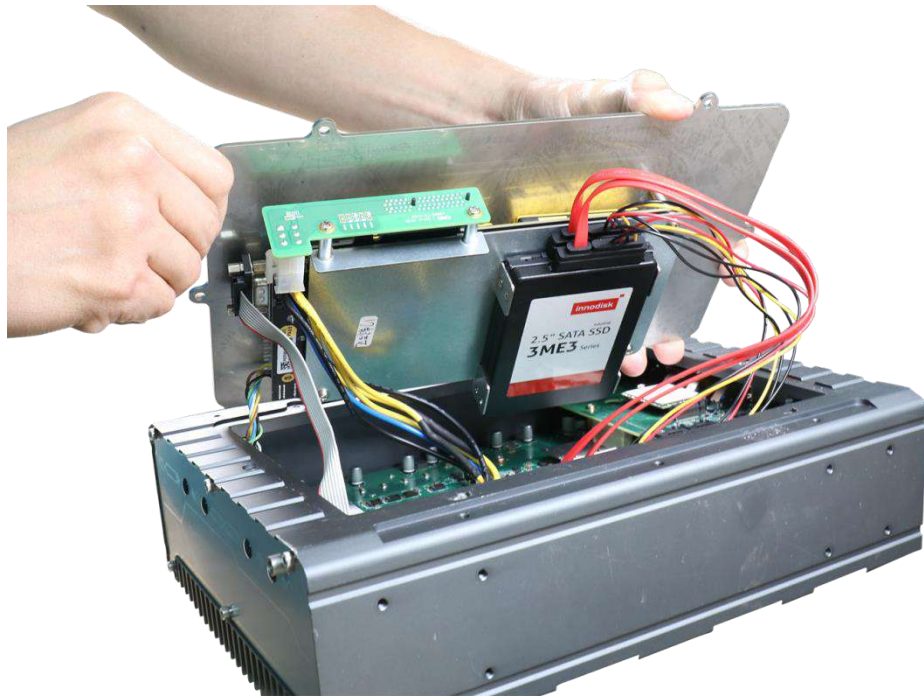

5. It is recommended that you disconnect the cables to better access and install components.

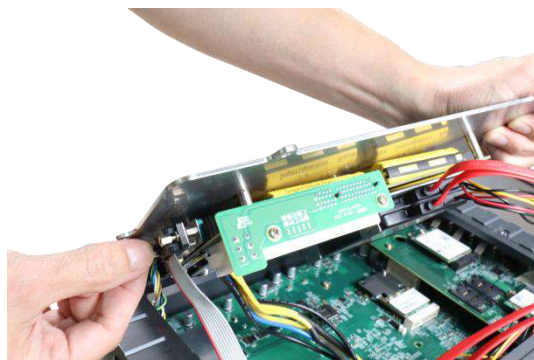

Unplug the DB9 connection to the PB unit

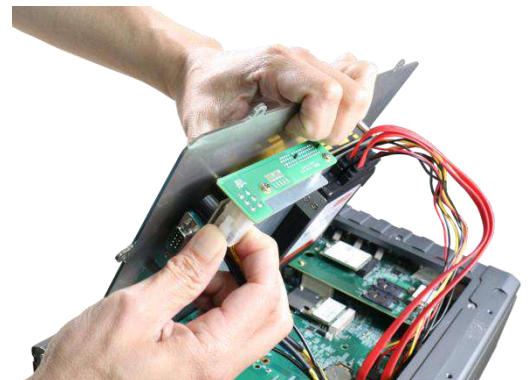

Unplug the 4-pin ATX connector



Disconnect the 4-pin power connector



Disconnect from the motherboard side

- If you are replacing existing HDD, disconnect the SATA/ power connector. Pull using the connector body, **DO NOT** pull on the cable!



Disconnect the SATA/ power connector



Remove screws on both sides of the hard drive

- Place the hard drive in between the brackets and secure with screws on both sides. Repeat this step if you are installing a second HDD.



Place hard drive in between brackets



Secure hard drive with screws on both sides

- Connect the SATA/ power cable onto the HDDs.



Connect the bottom hard drive first



Then connect the hard drive on top (if installed)

9. Reconnect the cables for the PB module.

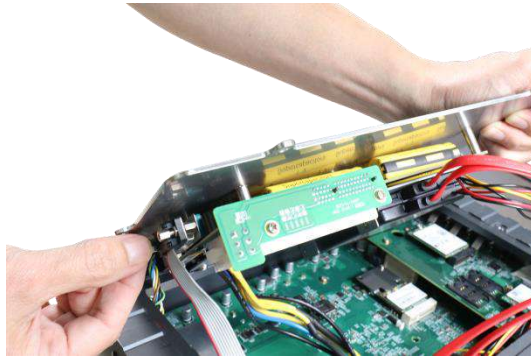

Connect the DB9 connection

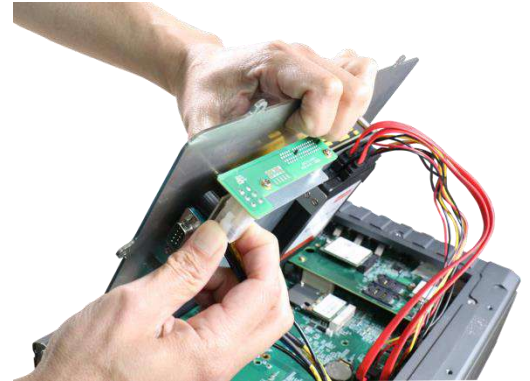

Plug in the 4-pin ATX connector



Connect the 4-pin power connector

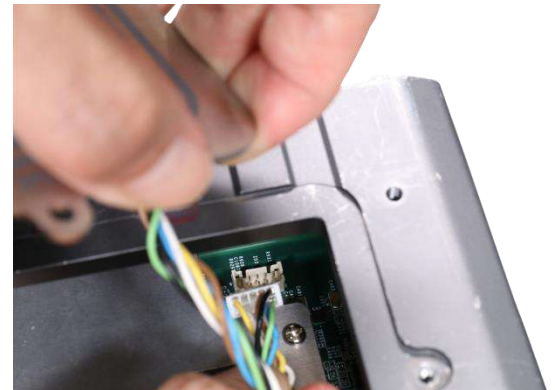

Connect from the motherboard side

10. Gently tug all the cables into the enclosure and shut the bottom panel back on.

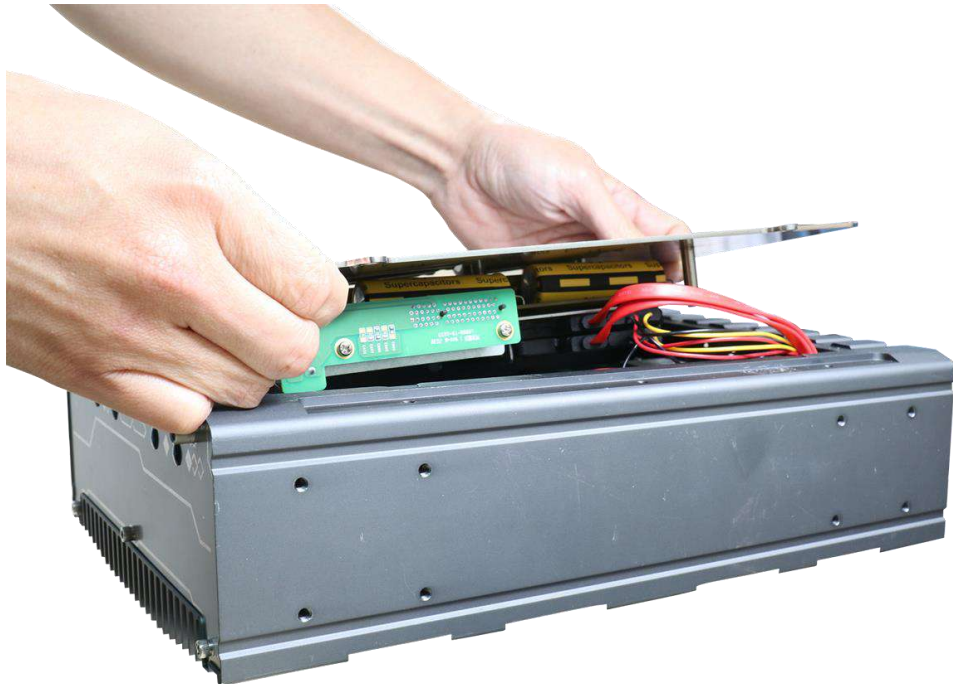

11. Secure the indicated screws in ascending order to complete the HDD installation procedure.

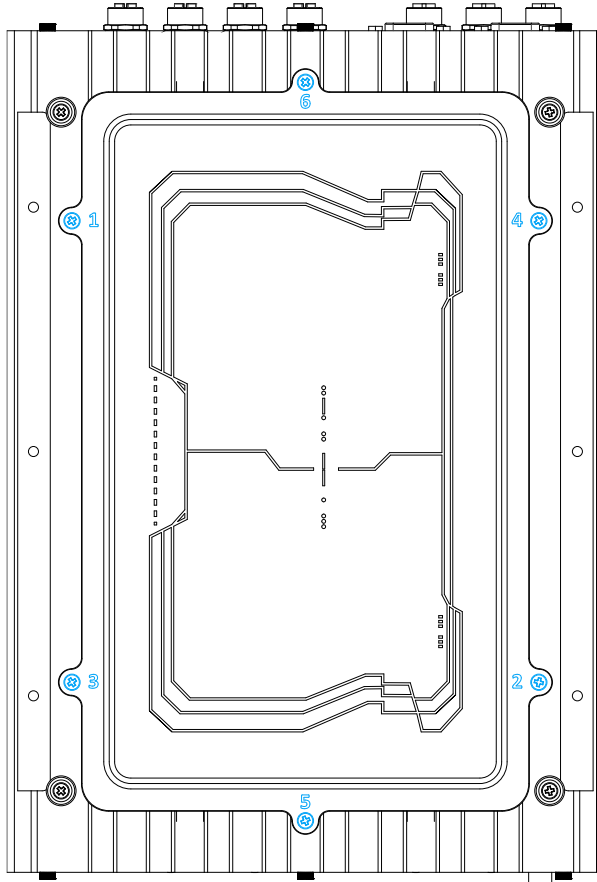

3.4 Wall-mount Bracket Installation

The system comes with four wall-mount installation brackets. The four brackets are interchangeable and can be installed on any of the four locations designated for bracket installation. Please follow the procedures below to install the brackets.

1. Remove the four brackets and sixteen screws from the accessory box.
2. To install the bracket (in **red**), simply secure it using the screws (in **blue**) provided.

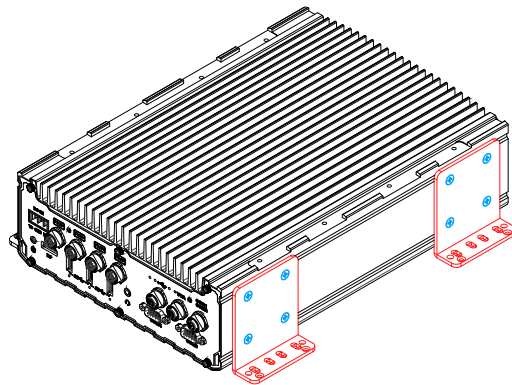

Left side bracket

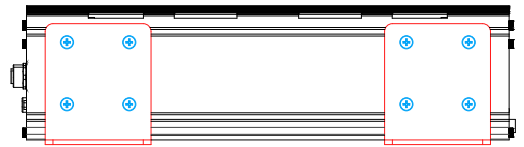

Left side view

3. Repeat the same bracket installation on the other side of the enclosure.

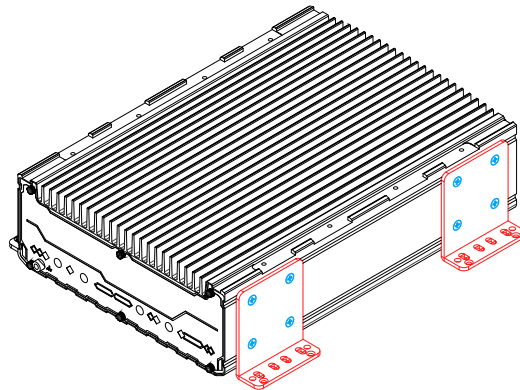

Rear 45 degree view

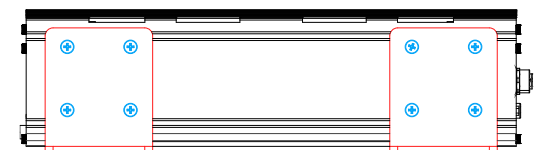

Right side view

3.5 Rack-mount Bracket Installation (Optional Accessory)

The system comes with optional rack-mount brackets. The two brackets can be installed so the system can be mounted into a standard 19" server cabinet. Please follow the procedures below to install the brackets.

1. There are two brackets and eight screws for this kit.
2. The larger-sized bracket (in red) is to be installed on the left side (next to the COM port side) of the enclosure with the screws (in blue) supplied.

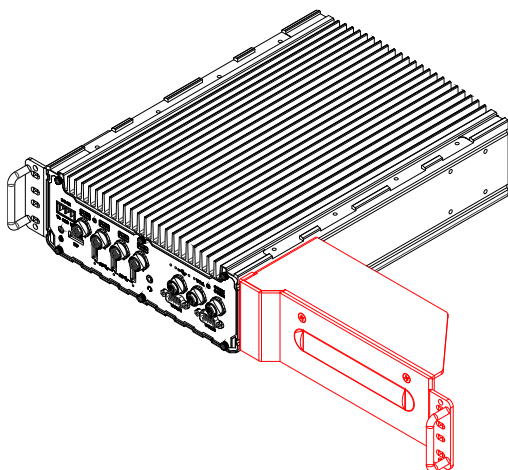

Left side bracket



Screws securing the bracket

3. The smaller bracket (in red) with the four screws (in blue) supplied

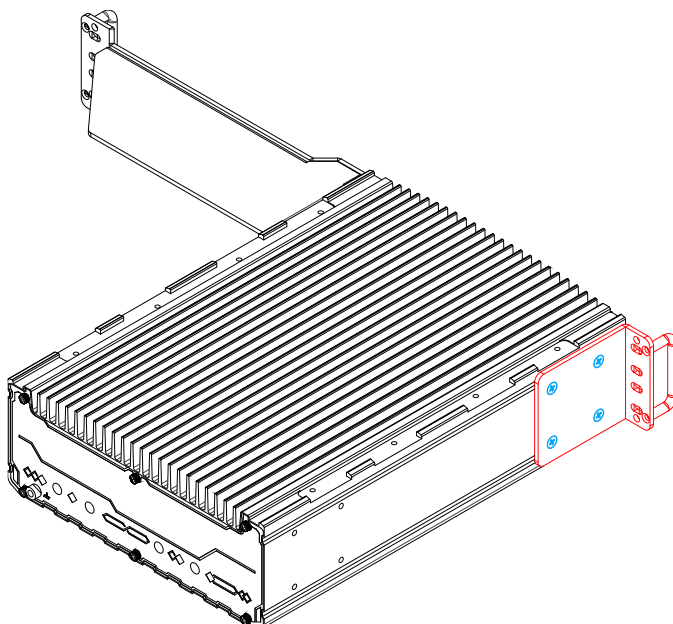

Right side bracket

3.6 Ignition Power Control

The ignition power control module for in-vehicle applications is a MCU-based implementation that monitors the ignition signal and reacts to turn on/off the system according to predefined on/off delay. Its built-in algorithm supports other features such as ultra-low power standby, battery-low protection, system hard-off, etc. In this section, we'll illustrate the principle of ignition power control and operation modes.

3.6.1 Principles of Ignition Power Control

The basic concept of ignition power control module is to control the timing correlation between ignition signal and system power status. A typical timing correlation is described in following diagram.

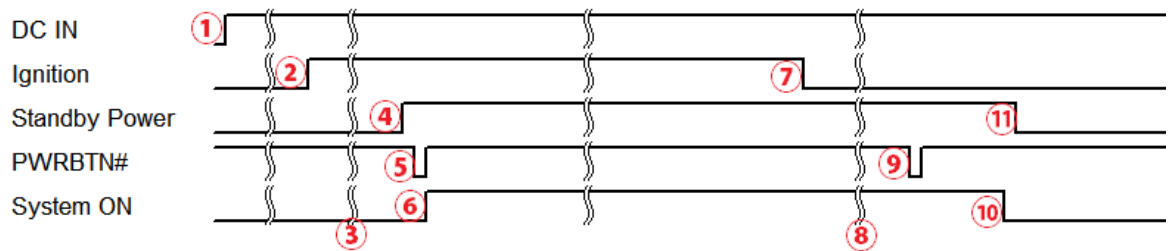

1. When DC power is supplied to the system, MCU starts to periodically detect ignition signal. Note that only MCU is working at this moment and the overall power consumption is less than 2 mW.
2. Ignition signal is active (both 12VDC and 24VDC ignition signals are accepted).
3. MCU starts to count a pre-defined power-on delay.
4. Once power-on delay expired, MCU turns on necessary standby power for the system (3.3VSB & 5VSB).
5. A PWRBTN# pulse is then issued to turn on the system (equivalent to one pressing the power button on the front panel).
6. The system is booting and becomes operational.
7. After a period of time, the ignition signal becomes inactive.
8. MCU starts to count a pre-defined power-off delay.
9. Once power-off delay expired, another PWRBTN# pulse is issued to perform a soft-off for the system (ex. a normal shutdown process for Windows system).
10. The system is completely shut down.
11. As MCU detects system is off, it turns off the standby power for the system, and operates in low power mode again (< 2mW power consumption).

3.6.2 Additional Features of Ignition Power Control

In addition to the typical timing correlation, the ignition power control module offers additional features to provide additional reliability for in-vehicle applications.

1. Low battery detection

The ignition power control module continuously monitors the voltage of DC input when the system is operational. If input voltage is less than 11V (for 12VDC input) or less than 22V (for 24VDC input) over a 60-second duration, it will shut down the system automatically.

2. Guarded power-on/ power-off delay duration

If ignition signal goes inactive during the power-on delay duration, the ignition power control module will cancel the power-on delay process and go back to idle status. Likewise if ignition signal goes active during the power-off delay duration, the ignition power control module will cancel the power-off delay process and keep the system running.

3. System hard-off

In some cases, system may fail to shutdown via a soft-off operation due to system/ application halts. The ignition power control module offers a mechanism called “hard-off” to handle this unexpected condition. By detecting the system status, it can determine whether the system is shutting down normally. If not, the ignition power control module will force cut-off the system power 10 minutes after the power-off delay duration.

4. Smart off-delay

The ignition power control module offers two modes (mode 13 & mode 14) which have very long power-off delay duration for applications require additional off-line time to process after the vehicle has stopped. In these two modes, the ignition power control module will automatically detect the system status during the power-off delay duration. If the system has shutdown (by the application software) prior to power-off delay expiring, it will cut off the system power immediately to prevent further battery consumption.

3.6.3 Wiring Ignition Signal

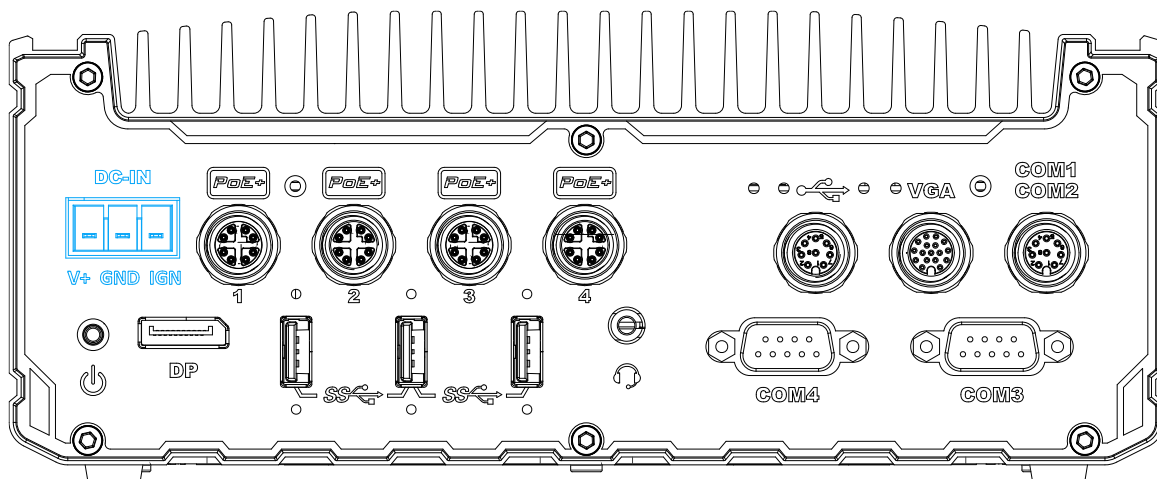

To have ignition power control for in-vehicle usage, you need to supply IGN signal to the system. The IGN input is located on the 3-pin pluggable terminal block (shared with DC power input). Below is the typical wiring configuration for in-vehicle applications.

1. Connect car Battery+ line (12V for sedan, 24V for bus/truck) to V+.
2. Connect car Batter-/ GND line to GND.
3. Connect ACC line to IGN.

 **WARNING**

Please make sure your DC power source and IGN signal share the same ground.

IGN input accepts 8-48VDC. Supply a voltage higher than 48VDC may damage the system.

3.6.4 Configure your Windows system for Ignition Control

When applying ignition power control to your system, please make sure you've configured your Windows system to initiate a shutdown process when pressing the power button. By default, Windows 7/ 8/ 10 goes to sleep (S3) mode when power button is pressed. As sleep (S3) is not a complete shutdown behavior, the ignition control function does not recognize the finish of a normal shut down process and thus users will encounter a system hard-off (power cut-off after 10 minutes). Please configure "When I press the power button" to "Shut down" in your Windows system settings.

Power button settings

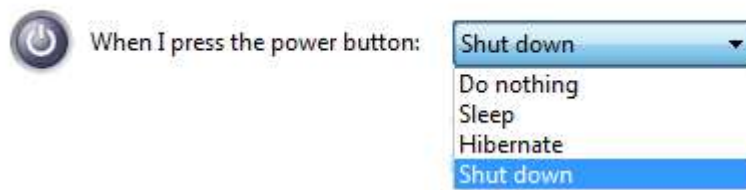

3.7 Accessing the Rotary Switch

To access the rotary switch, please refer to the section Disassembling the System.

1. Please power off the system and disconnect all cables connected to the system. Place the system upside-down on a steady surface. Remove the ten (10) screws indicated, and safe keep for later use. Please separate the backplate from the system's enclosure.



2. The ignition control rotary switch can be located on the motherboard, shown below.

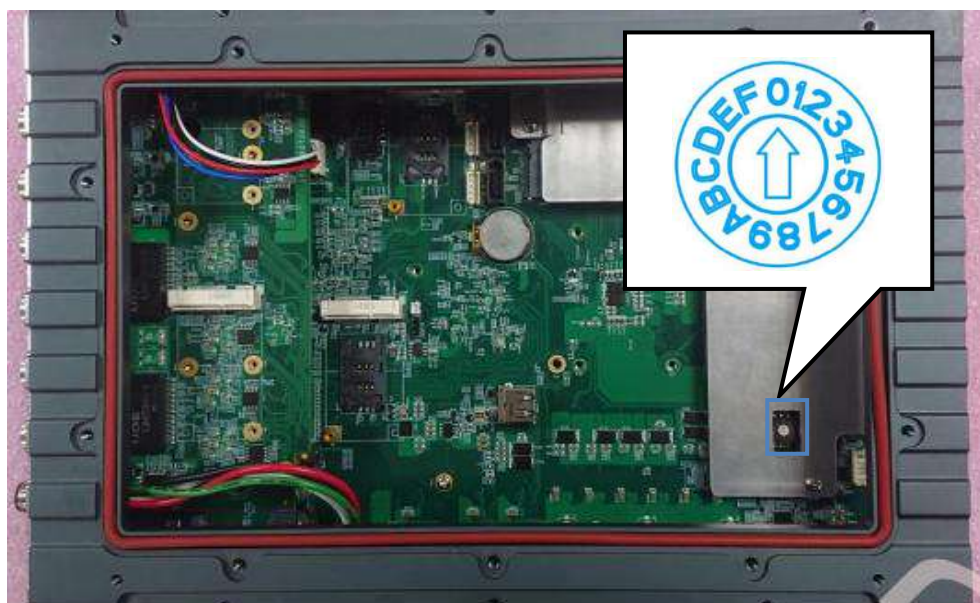

3.8 Operation Modes of Ignition Power Control

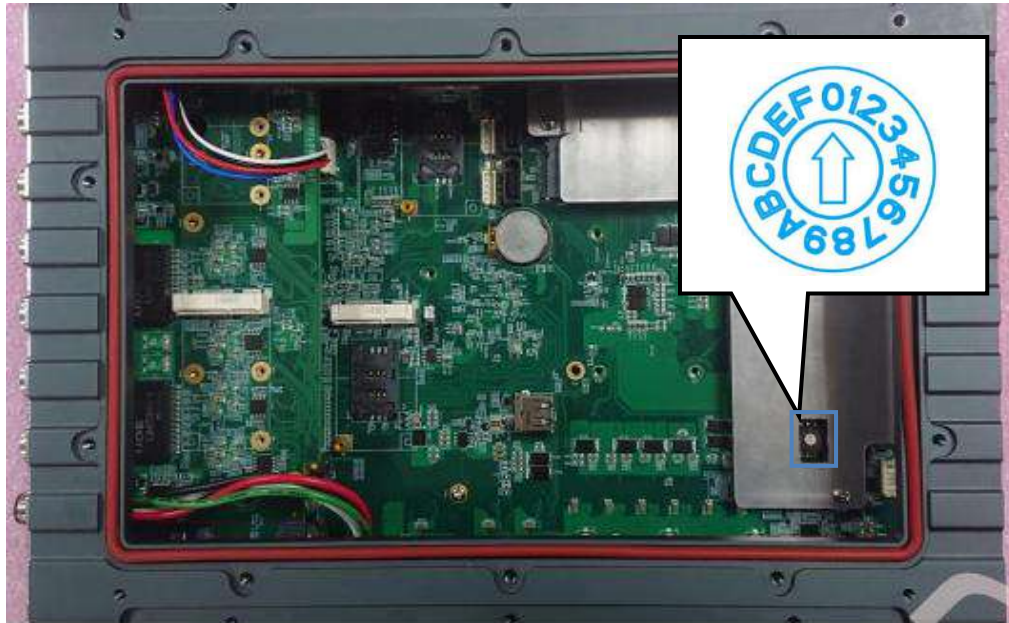

You can use the rotary switch to configure the operation mode. The system offers 16 (0~15) operation modes with different power-on/power-off delay configurations.

- **Mode 0**

Mode 0 is the ATX mode without power-on and power-off delay. User can only use the power button on the front panel to turn on or turn off the system.

Mode	Power-on Delay	Power-off Delay	Hard-off Timeout
0	N/A	N/A	N/A

- **Mode 1**

Mode 1 is AT mode without power-on and power-off delay. The system automatically turns on when DC power is applied. A retry mechanism is designed to repeat the power-on cycle if the system fails to boot up.

Mode	Power-on Delay	Power-off Delay	Hard-off Timeout
1	N/A	N/A	N/A

- **Mode 2**

Mode 2 is designed to have a very minor power on/ off delay of 160ms for applications that requires the system to start up almost at the same as the rest of the equipment it is working in collaboration with.

Mode	Power-on Delay	Power-off Delay	Hard-off Timeout
2	160ms	160ms	10 minutes

- **Mode 3 ~ Mode 12**

Mode 3 ~ Mode 12 have various power-on delay and power-off delay. Each mode supports a hard-off timeout of 10 minutes.

Mode	Power-on Delay	Power-off Delay	Hard-off Timeout
3	10 seconds	10 seconds	10 minutes
4	10 seconds	1 minute	10 minutes
5	10 seconds	5 minutes	10 minutes
6	30 seconds	1 minute	10 minutes
7	30 seconds	5 minutes	10 minutes
8	30 seconds	10 minutes	10 minutes
9	3 minutes	1 minute	10 minutes
10 (A)	3 minutes	10 minutes	10 minutes
11 (B)	3 minutes	30 minutes	10 minutes
12 (C)	10 minutes	30 minutes	10 minutes

- **Mode 13 (D) / Mode 14 (E)**

Mode 13 and Mode 14 are ignition power control modes with very long power-off delay. Both modes support the feature of “smart off-delay”, which automatically detect system status during power-off delay duration and cut off system power if system is off in prior to power-off delay expired.

Mode	Power-on Delay	Power-off Delay	Hard-off Timeout
13 (D)	30 seconds	2 hours	10 minutes
14 (E)	3 minutes	2 hours	10 minutes
15 (F)	Reserved		

3.9 Reinstalling the Backplate

1. Once you have configured the ignition rotary switch, you are ready to re-secure the backplate.
2. Before doing so, please make sure the O-ring is properly seated in the groove around the chassis edges.
3. Please attached the backplate, and secure the plate using the original ten screws in the following incremental order, and at the torque force specified.



NOTE

The recommended torque range for screws is 6.3 to 7.7 kgf-cm



O-ring seated properly in the groove



Attach the backplate, incremental screw order, and at a specified torque range (6.3 to 7.7 kgf-cm)

3.10 Ignition Control Setup

The following procedure demonstrates how to remove the backplate of a SEMIL-17XX series to gain access to the ignition control rotary switch.

3. Please power off the system and disconnect all cables connected to the system. Place the system upside-down on a steady surface. Remove the ten (10) screws indicated, and safe keep for later use. Please separate the backplate from the system's enclosure.

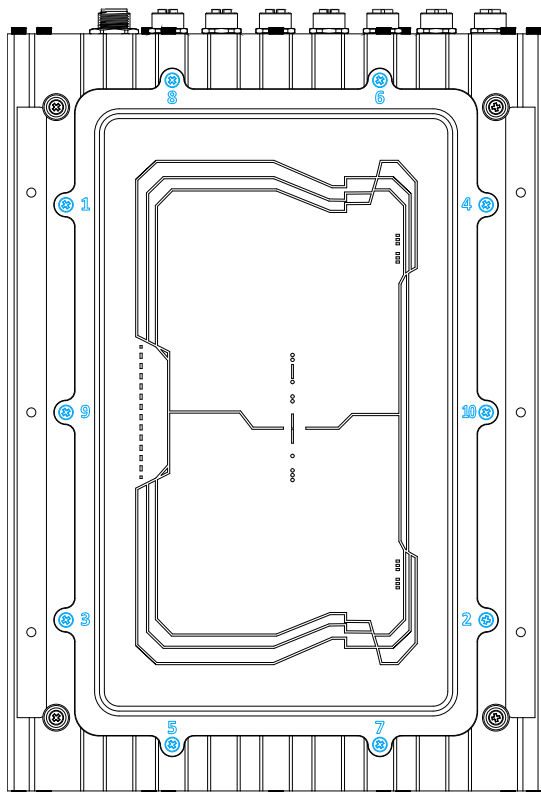

4. The ignition control rotary switch can be located on the motherboard, shown below.

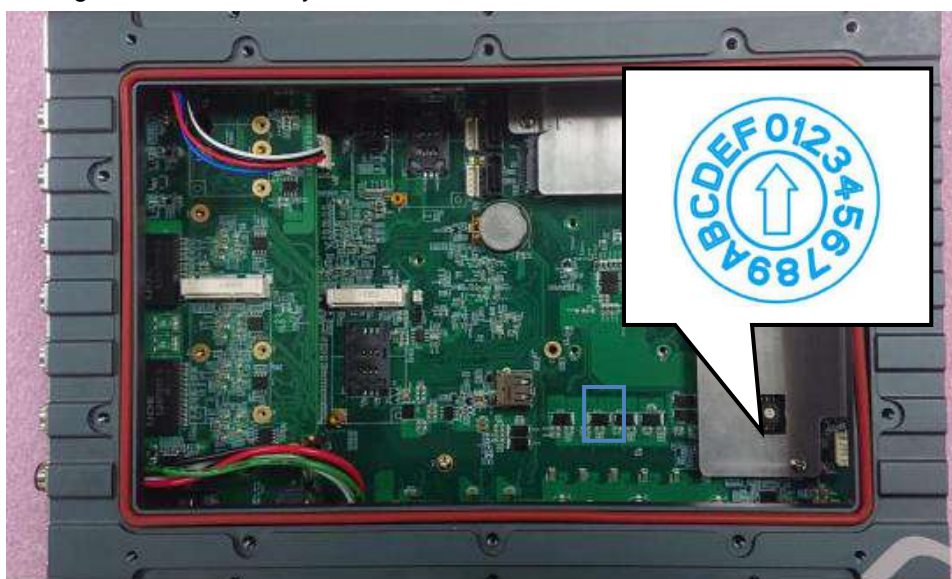

5. Operation Modes of Ignition Control

You can use the rotary switch to configure the operation mode. The system offers 16 (0~15) operation modes with different power-on/power-off delay configurations.

Mode 0

Mode 0 is the ATX mode without power-on and power-off delay. Users can only use the power button on the front panel to turn on or turn off the system.

Mode	Power-on Delay	Power-off Delay	Hard-off Timeout
0	N/A	N/A	N/A

Mode 1

Mode 1 is AT mode without power-on and power-off delay. The system automatically turns on when DC power is applied. A retry mechanism is designed to repeat the power-on cycle if the system fails to boot up.

Mode	Power-on Delay	Power-off Delay	Hard-off Timeout
1	N/A	N/A	N/A

Mode 2

Mode 2 is designed to have a very minor power on/ off delay of 160ms for applications that require the system to start-up almost at the same as the rest of the equipment it is working in collaboration with.

Mode	Power-on Delay	Power-off Delay	Hard-off Timeout
2	160ms	160ms	10 minutes

Mode 3 ~ Mode 12

Mode 3 ~ Mode 12 have various power-on delays and power-off delays. Each mode supports a hard-off timeout of 10 minutes.

Mode	Power-on Delay	Power-off Delay	Hard-off Timeout
3	10 seconds	10 seconds	10 minutes
4	10 seconds	1 minute	10 minutes
5	10 seconds	5 minutes	10 minutes
6	30 seconds	1 minute	10 minutes
7	30 seconds	5 minutes	10 minutes
8	30 seconds	10 minutes	10 minutes
9	3 minutes	1 minute	10 minutes
10 (A)	3 minutes	10 minutes	10 minutes
11 (B)	3 minutes	30 minutes	10 minutes
12 (C)	10 minutes	30 minutes	10 minutes

Mode 13 (D) / Mode 14 (E)

Mode 13 and Mode 14 are ignition power control modes with very long power-off delays. Both modes support the feature of “smart off-delay”, which automatically

detect system status during power-off delay duration and cut off system power if the system is off before the power-off delay expires.

Mode	Power-on Delay	Power-off Delay	Hard-off Timeout
13 (D)	30 seconds	2 hours	10 minutes
14 (E)	3 minutes	2 hours	10 minutes

Mode 15 (F)

Reserved

6. Once you have configured the ignition rotary switch, you are ready to re-secure the backplate.
7. Before doing so, please make sure the O-ring is properly seated in the groove around the chassis edges.
8. Please attached the backplate, and secure the plate using the original ten screws in the following incremental order, and at the torque force specified.



NOTE

The recommended torque range for screws is 6.3 to 7.7 kgf-cm



O-ring seated properly in the groove

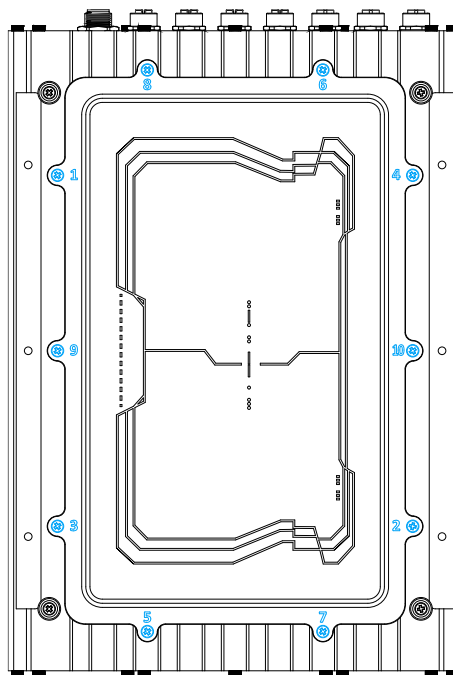

Attach the backplate, incremental screw order, and at a specified torque range (6.3 to 7.7 kgf-cm)

4.1.1 COM Port Configuration

The system's [COM1/COM2](#) ports support RS-232 (full-duplex) mode.

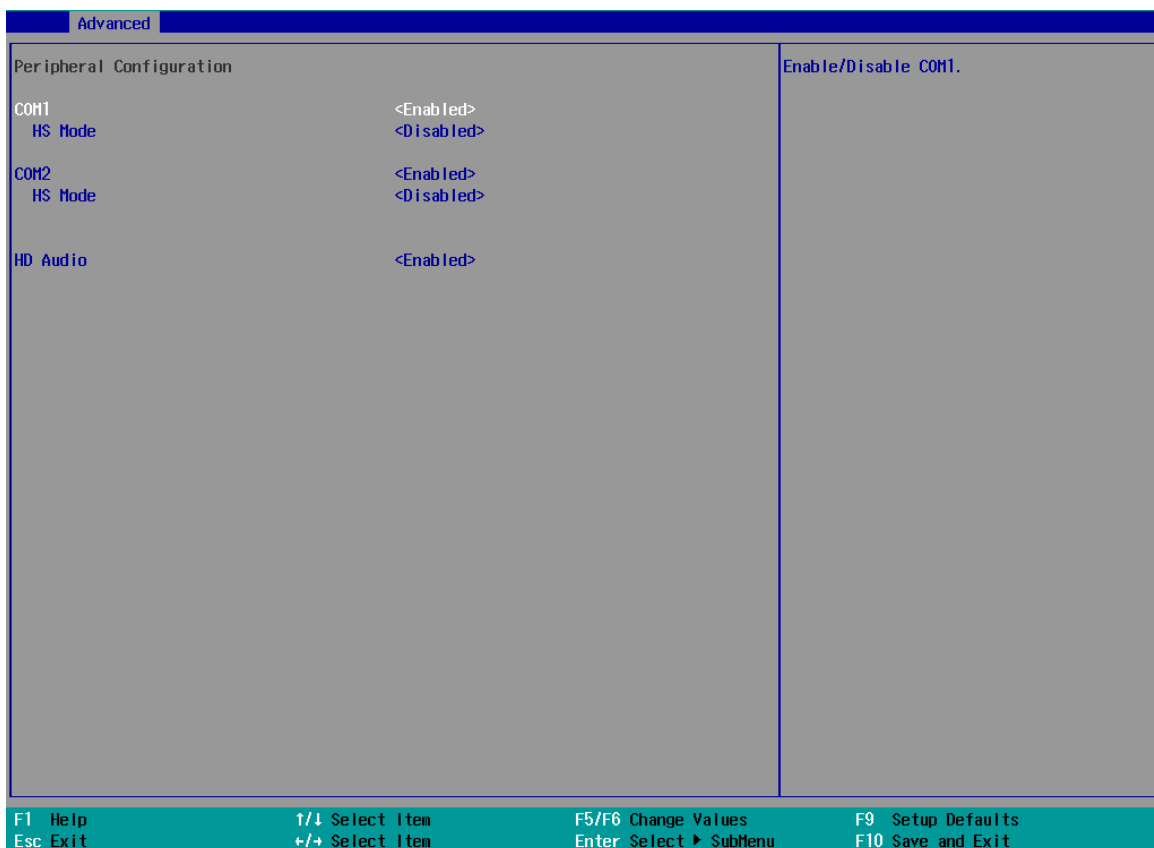

To set COM port operating mode:

1. Press **F2** when the system boots up to enter the BIOS setup utility.
2. Go to **[Advanced]** → **[Peripheral Configuration]**.
3. Highlight the COM port and select **[Enable]** or **[Disable]**, press ENTER to confirm selection.
4. Once set, press **F10** to save setting and exit.

4.1.2 COM Port High Speed Mode

The high speed mode of each COM port effectively allows for the port's baud rate generator to operate at 8x the speed with an effective baud rate of 921,600 bps (115,200 x 8). Please refer to the following instructions on how to enable the high speed mode for your COM port (COM1 used as an example).

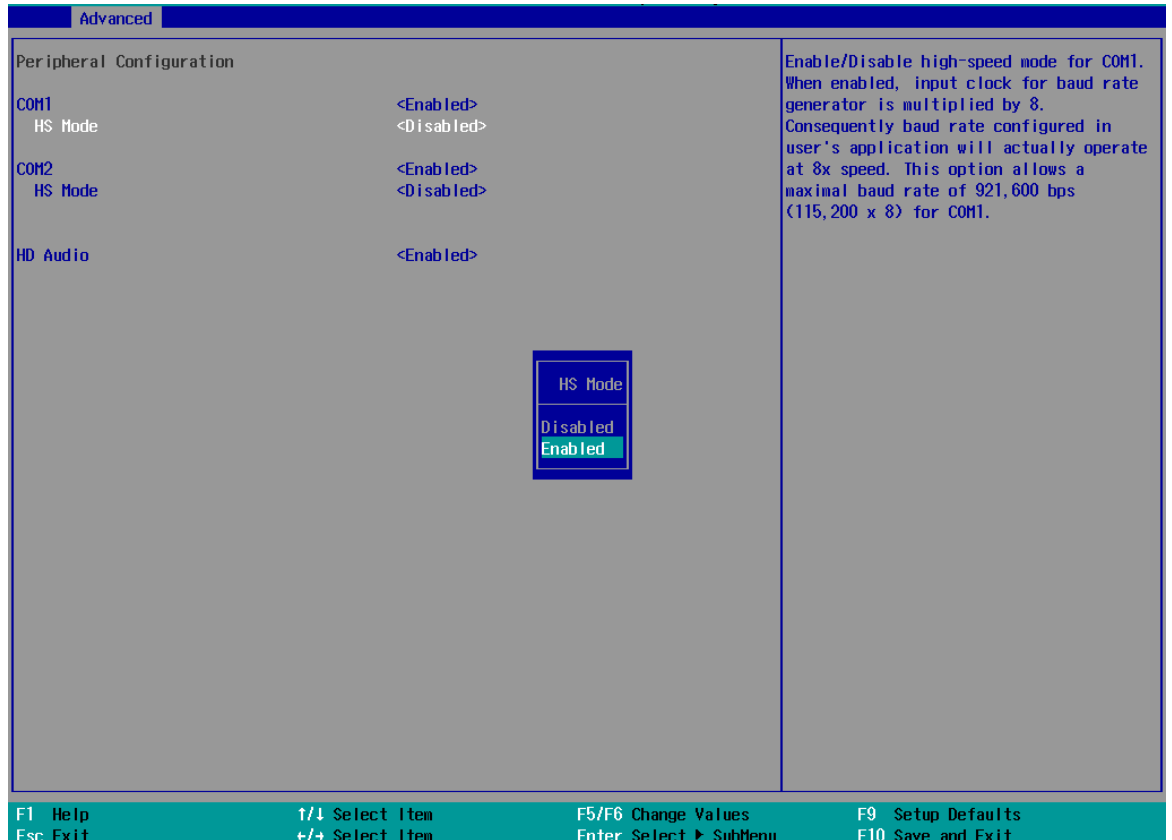

To set COM port high speed mode:

1. Press **F2** when the system boots up to enter the BIOS setup utility.
2. Go to **[Advanced] > [Peripheral Configuration]**.
3. Highlight **[HS Mode]** and press ENTER to bring up options, select **[Enable]** or **[Disable]**, and press ENTER to make your selection.
4. Once set, press **F10** to save setting and exit.

4.1.3 SATA Configuration

The SATA controller of your system supports two (2) operating modes: **AHCI** and **Intel RST Premium With Intel Optane System Acceleration mode**. The **AHCI** mode, which exposes SATA's advanced capabilities such as hot swapping and native command queuing, is supported in several later version of operating systems. The **Intel RST Premium With Intel Optane System Acceleration** mode allows the user to greatly accelerate SATA hard drive read/ write speeds by installing an Optane memory into the M.2 slot. Please refer to the section “**Intel RST Premium With Intel Optane System Acceleration**” for details.

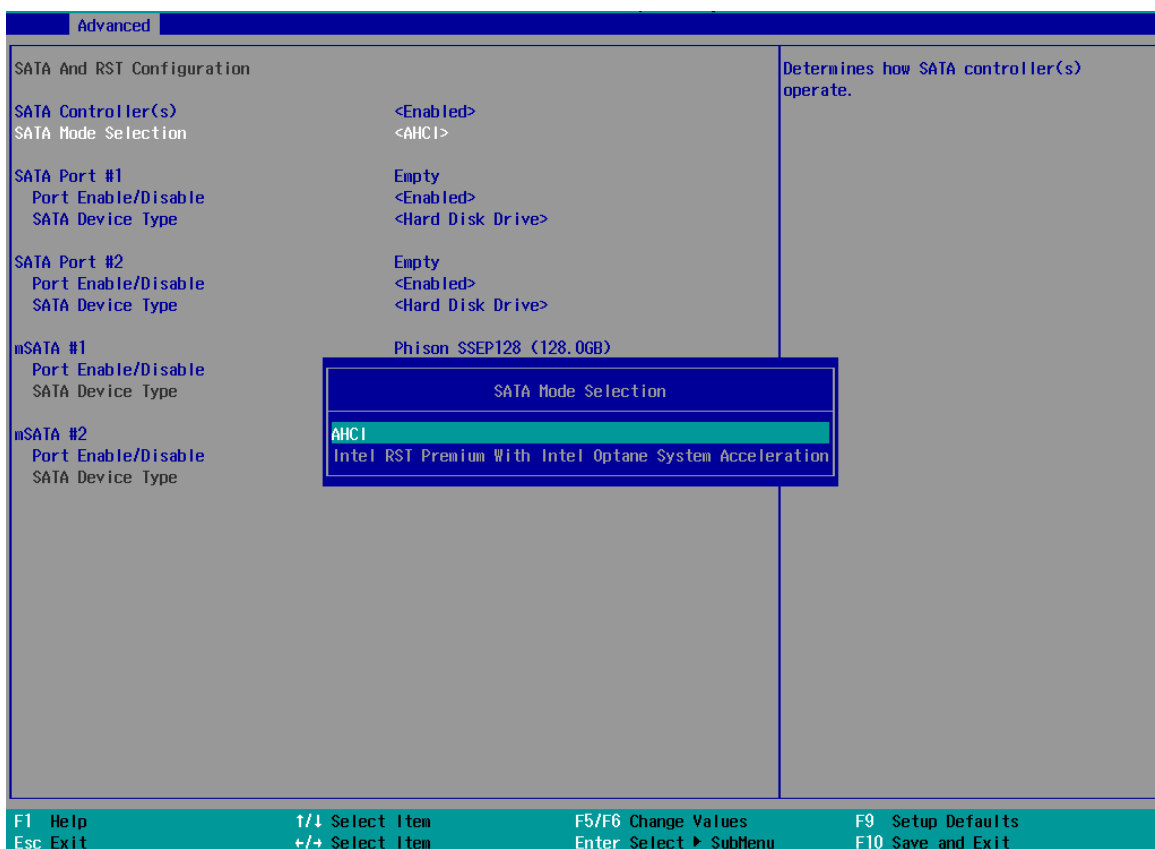

Recommended SATA controller mode settings:

- If you're using Windows 10, or Linux with kernel 4.15.18 or later, you can select **AHCI** mode for better performance.
- If you are looking for faster hard drive read/ write performance, please install an SSD (M.2, mPCIe, SATA) or install an Intel® Optane™ memory for hard drive acceleration.

To set SATA controller mode:

1. When system boots up, press F2 to enter BIOS setup utility.
2. Go to **[Advanced] > [SATA Configuration]**.
3. Highlight the SATA, mSATA or M.2 port you wish to set and press ENTER to bring up setting options. Scroll to and highlight the setting you wish to set and press ENTER.



4. Repeat step 3 to set other SATA ports.
5. Press F10 to "Exit Saving Changes".

4.1.4 TPM Availability

Trusted Platform Module (TPM) is a hardware-based cryptoprocessor to secure hardware by integrating cryptographic keys into devices. The system is designed with on-board TPM 2.0 module. As TPM 2.0 requires 64-bit Windows 10 with UEFI boot mode, it is enabled in BIOS by default.

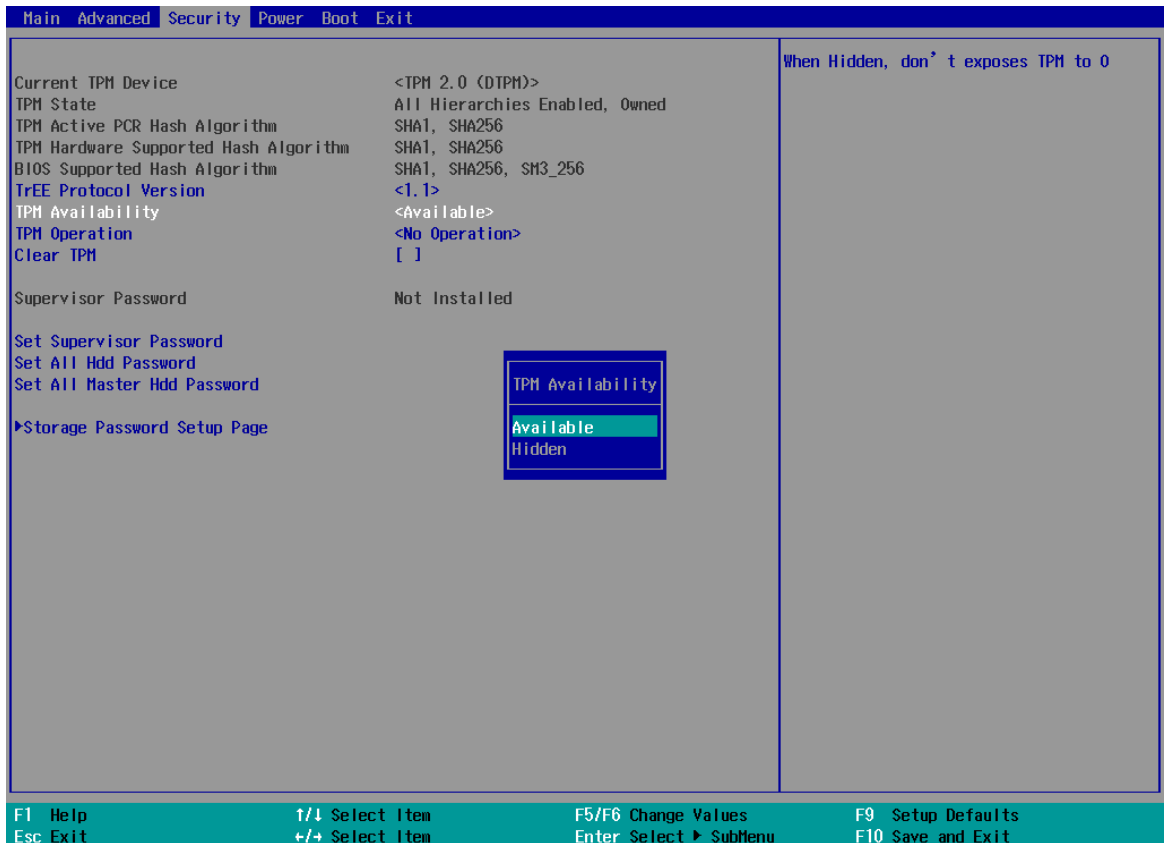

To enable TPM availability:

1. When system boots up, press F2 to enter BIOS setup utility.
2. Go to **[Security] > [TPM Availability]**, press Enter to bring up Options, Available/Hidden.
3. Highlight your selection, press Enter and press F10 to "Exit Saving Changes".

4.1.5 Auto Wake on S5

When the system is set to operate in S5 state, the user can specify a time to turn on the system, daily or monthly.



Value	Option	Description
Auto Wake on S5	Disabled	The system does not turn on when operating in state S5.
	By Every Day	The system turns on each day when operating in state S5. Specify the time of day.
	By Day of Month	The system turns on each month when operating in state S5. Specify the day and time.

Highlight your selection, press ENTER and press F10 to “Exit Saving Changes”.

4.1.6 Power On After Power Failure Option

This option defines the behavior of system series when DC power is supplied.

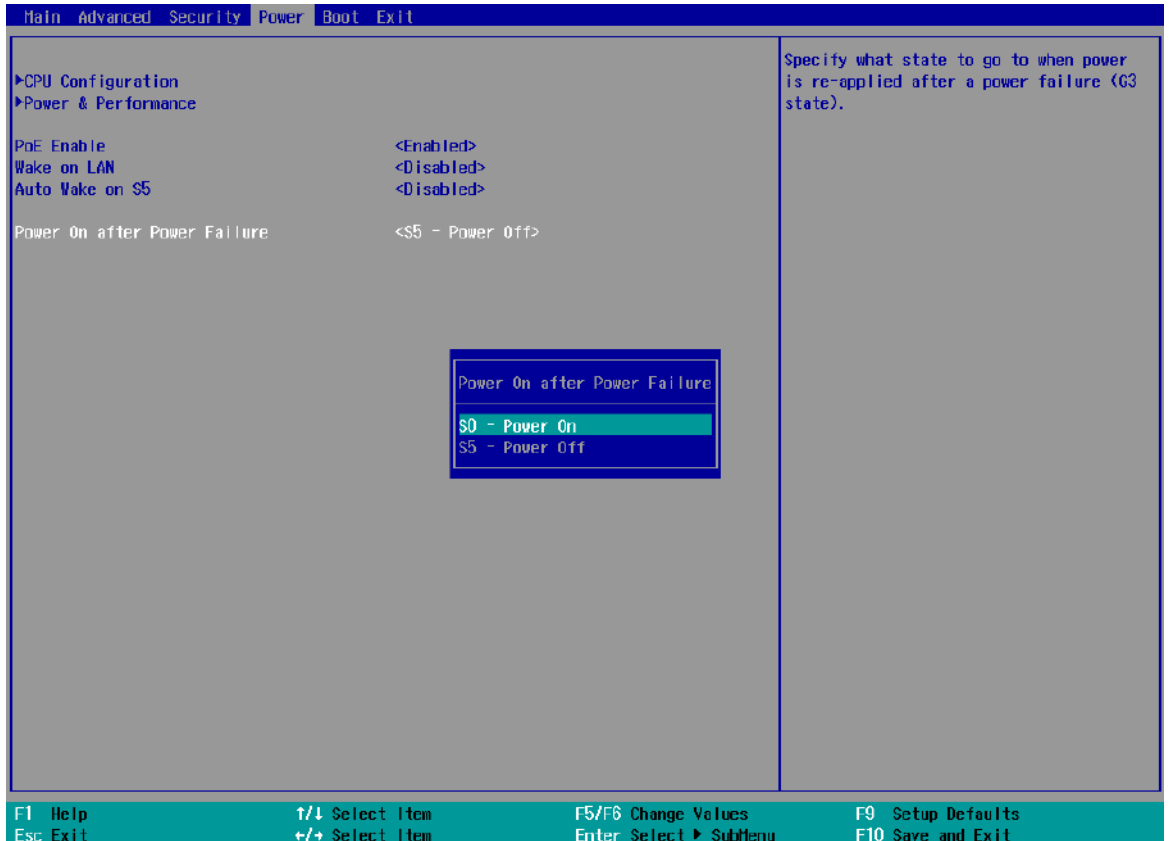

Value	Description
S0 – Power On	System is powered on when DC power is supplied.
S5 – Power Off	System is kept in off state when DC power is supplied.

To set “Power On after Power Failure” option:

1. When system boots up, press F2 to enter BIOS setup utility.
2. Go to **[Power] > [Power On after Power Failure]**.
3. Scroll down to highlight **[Power On after Power Failure]**, press ENTER to bring up setting options, S0 – Power On or S5 – Power Off, and press ENTER to select the setting.
4. Press F10 to “Exit Saving Changes”.

4.1.7 Power & Performance (CPU SKU Power Configuration)

The system supports various 9th/ 8th-Gen Coffee Lake LGA1151 CPUs. A unique feature, “**SKU Power Config**” is implemented in BIOS to allow users to specify user-defined SKU power limit. Although the system is designed to have best thermal performance with CPUs of 35W TDP, you can install a 65W CPU and limit its SKU power (to 35W) to obtain more computing power. This feature gives you the flexibility of CPU selection and great balance between computing power and operating temperature range.

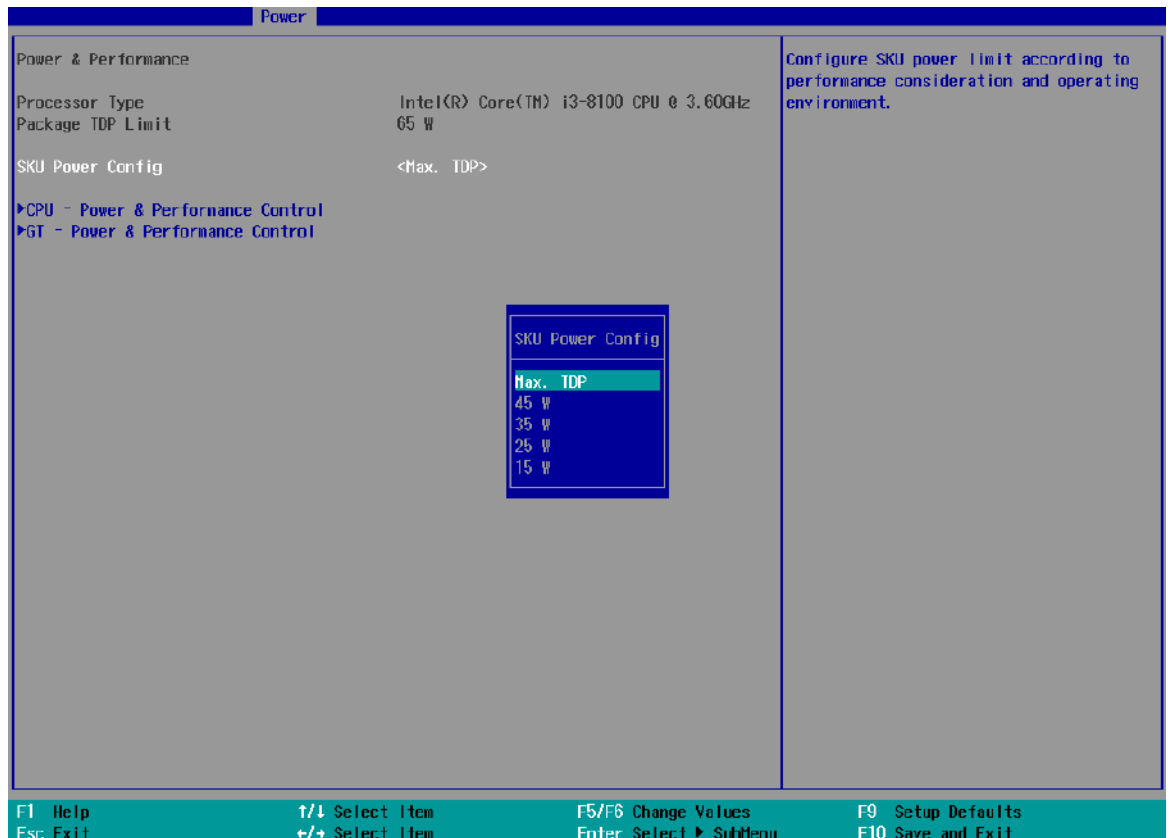

To configure the CPU SKU power limit:

1. When the system boots up, press F2 to enter BIOS setup utility.
2. Go to **[Power]** → **[Power & Performance]**.
3. Select a proper value of SKU power limit for **[SKU Power Config]** option.
4. Press F10 to "Exit Saving Changes".

4.1.8 Wake on LAN Option

Wake-on-LAN (WOL) is a mechanism which allows you to turn on your System series via Ethernet connection. To utilize Wake-on-LAN function, you have to enable this option first in BIOS settings. Please refer "[Powering On Using Wake-on-LAN](#)" to set up the system.



To enable/disable "Wake on LAN" option:

1. When system boots up, press F2 to enter BIOS setup utility.
2. Go to **[Power] > [Wake on LAN]**.
3. Press Enter to bring up setting options, scroll to the setting you desire and press Enter to set.
4. Press F10 to "Exit Saving Changes."

4.1.9 Boot Menu

The Boot menu in BIOS allows you to specify the system’s boot characteristics by setting bootable device components (boot media) and method. Or, you may press F12 upon system start up and select a device you wish boot from.

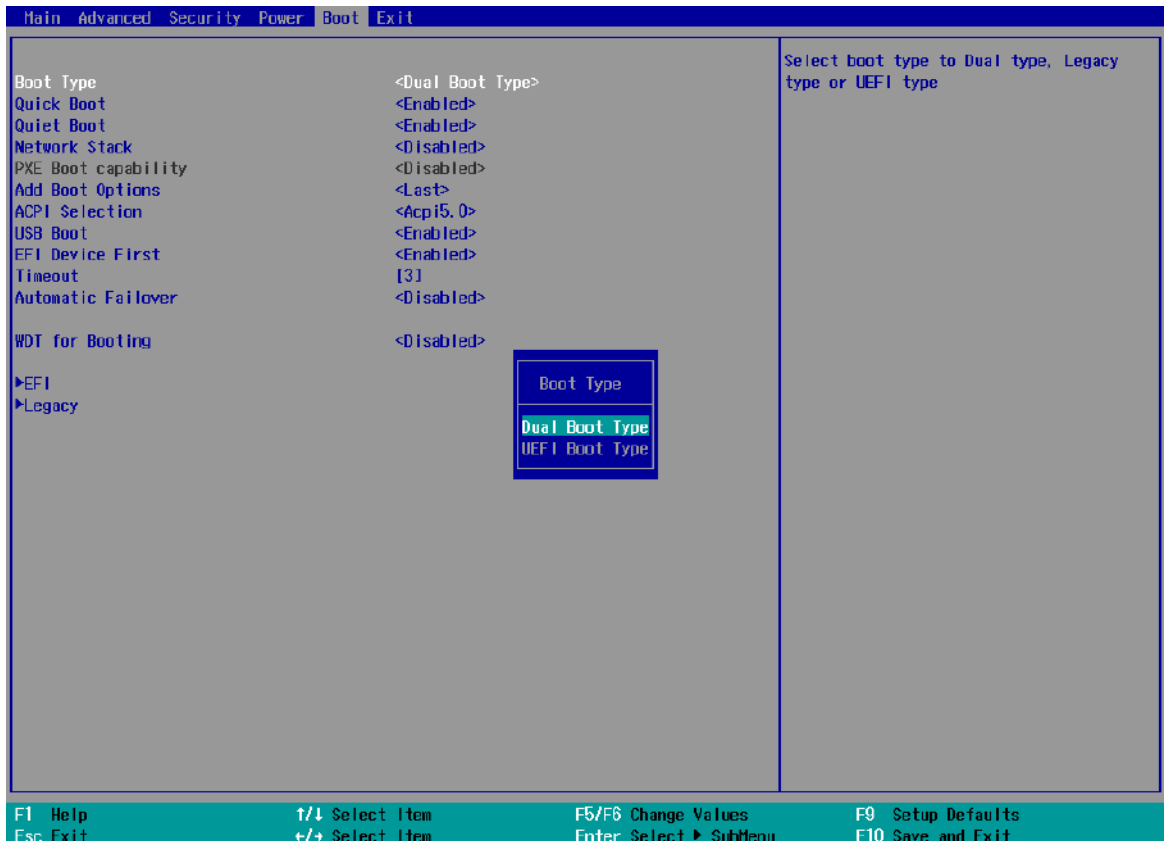



Value	Option	Description
Boot Type	Dual Boot Type	Both legacy and EFI boot media listed are approved as boot media.
	Legacy Boot Type	Only legacy boot media listed are approved as boot media.
	UEFI Boot Type	Only UEFI boot media listed are approved as boot media.
Quick Boot	Enabled	The system starts up faster because BIOS skips various hardware function tests
	Disabled	The system starts up slower because BIOS goes through various hardware functions tests
Network Stack	Enabled	The system is available for network access using UEFI.
	Disabled	The system is not available for network access

		using UEFI.
PXE Boot capability	Disabled	Only UEFI Network Stack is supported: Preboot eXecution Environment (PXE) is not supported
	Enabled	By enabling the PXE boot, one can choose to boot via I219 Only/ I210 Only or All NICs .
Add Boot Options	First	Newly detected boot media are placed at the top of the boot order.
	Last	Newly detected boot media are placed at the bottom of the boot order.
ACPI Selection	1.0B/ 3.0/ 4.0/ 5.0/ 6.0	Advanced Configuration and Power Interface allows the operating system to control system power management
USB Boot	Enabled	Allow boot from bootable USB devices.
	Disabled	Does not allow boot from bootable USB devices
EFI Device First	Enabled	Set to boot bootable EFI media first.
	Disabled	Will not boot bootable EFI media first.
Timeout	1, 2, 3, etc (in seconds)	Boot delay time in seconds to give the user time to activate the hotkey to access the BIOS
Automatic Failover	Enabled	Automatically checks for the next bootable device when the set default device fails.
	Disabled	Will only boot from the designated device.
WDT for booting	Disabled, 1, 3, 5, 10 (minutes)	WDT ensures a successful system boot by specifying a timeout value

4.1.10 Boot Type (Legacy/ UEFI)

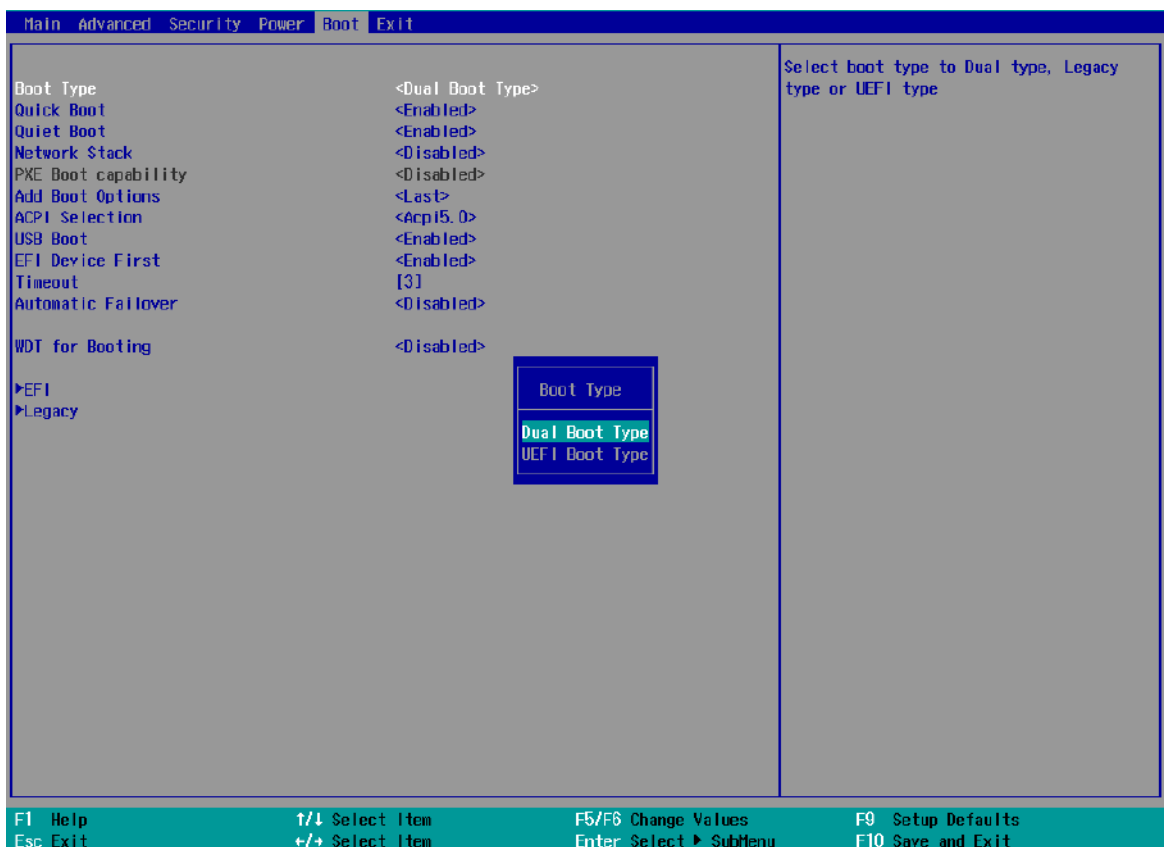
The system supports both Legacy and Unified Extensible Firmware Interface (UEFI) boot modes. UEFI is a specification proposed by Intel to define a software interface between operating system and platform firmware. Most modern operating systems, such as Windows 7/ 8/ 10 and Linux support both Legacy and UEFI boot modes. The Legacy boot mode uses MBR partition for disk and VBIOS for video initialization, the UEFI boot mode uses GPT partition which supports greater than 2TB partition size and GOP driver for faster video initialization.



 **NOTE**

If you choose Legacy mode, you will not be able to create disk partitions greater than 2TB or use TPM 2.0 function.

To configure Boot Type:

1. When system boots up, press F2 to enter BIOS setup utility.
2. Go to **[Boot]>[Boot Type]**, press Enter to bring up options, Dual Boot (Legacy+UEFI), Legacy Boot Type, UEFI Boot Type.
3. Highlight your selection and press Enter.

4. Press F10 to "Exit Saving Changes".

5.

4.1.11 Boot Option for Newly Added Device

The “Add Boot Options” allow you to determine whether a newly added device (eg. USB flash disk) is to boot as the first device to boot or the last in the boot sequence.

To set the newly-installed boot device as the first or last boot device:

1. Press **F2** when the system boots up to enter the BIOS setup utility.
2. Go to **[Boot] > [Add Boot Options]** menu.
3. Select **[First]** or **[Last]** for your newly-added boot device and press ENTER.

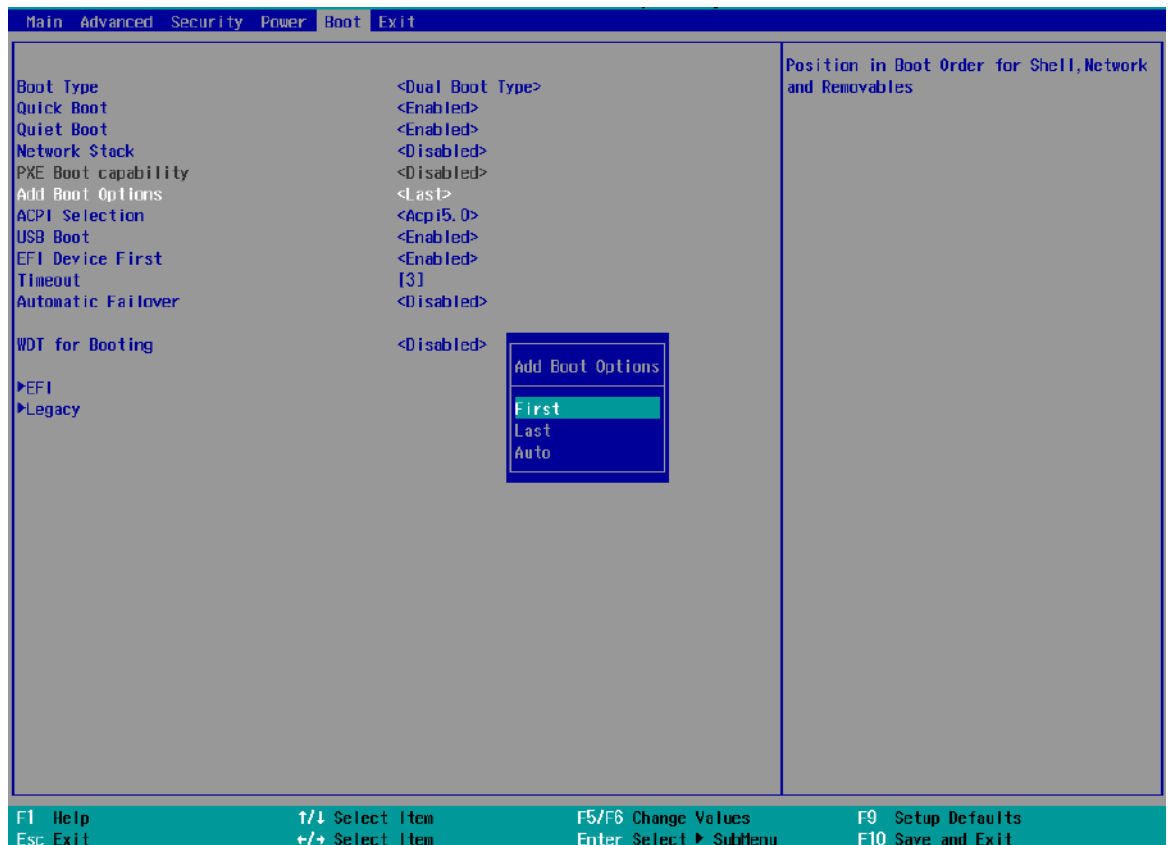

4. Highlight your selection and press Enter, press F10 to “Exist Saving Changes”.

4.1.12 Watchdog Timer for Booting

The watchdog timer secures the boot process by means of a timer. Once the timer expires, a reset command is issued to initiate another booting process. There are two options in BIOS menu, “*Automatically after POST*” and “*Manually after Entering OS*”. When “*Automatically after POST*” is selected, the BIOS automatically stops the watchdog timer after POST (Power-On Self Test) OK. When “*Manually after Entering OS*” is selected, the user must stop the watchdog timer once booted into the OS. This guarantees the system can always boot into the OS, otherwise another booting process will be initiated. For information about programming watchdog timer, please refer to [Watchdog Timer & Isolated DIO](#).

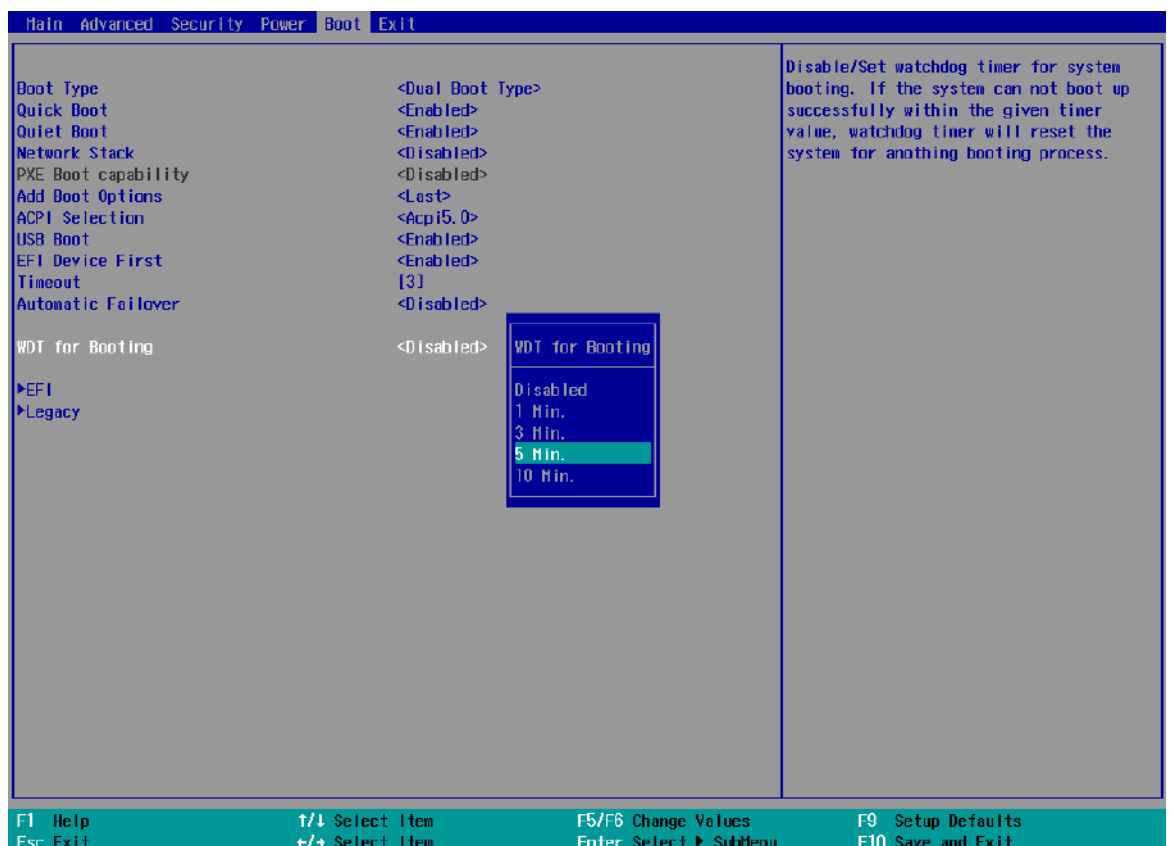

To set the watchdog timer for boot in BIOS:

1. When system boots up, press F2 to enter BIOS setup utility.
2. Go to **[Boot]** menu.
3. Disable or select timeout value for **[WDT for Booting]** option.
4. Once you give a timeout value, the **[WDT Stop Option]** option appears. You can select “*Automatically after POST*” or “*Manually after Entering OS*”.

5. Press F10 to “Exit Saving Changes.

4.1.13 Selecting Legacy/ UEFI Boot Device

When you wish to set a designated boot device, you may set it as the first device to boot in Legacy or UEFI Boot Device setting. Or if you wish to manually select a boot device, you may do so by pressing F12 when the system boots up

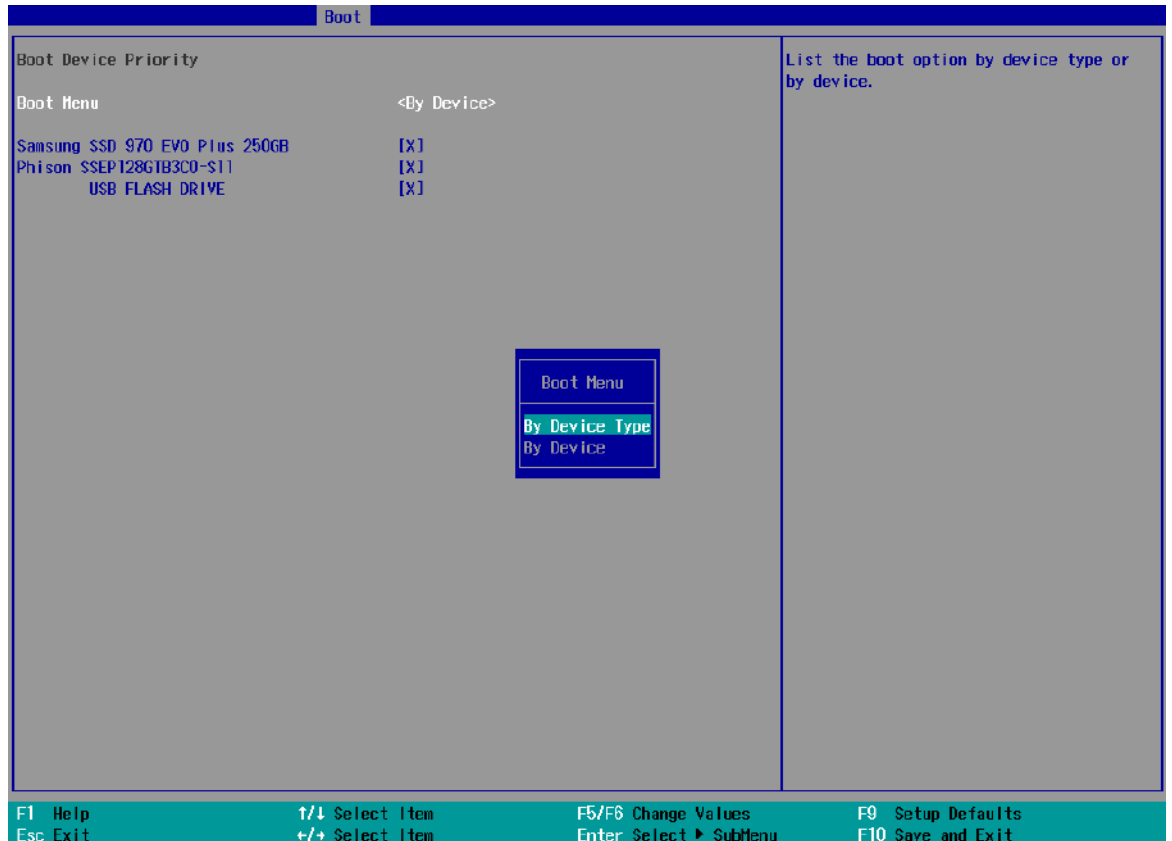

To set boot order for devices in UEFI Boot Device:

1. When system boots up, press F2 to enter BIOS setup utility
2. Go to **[Boot] > [UEFI Boot Device]**
3. Highlight the device you wish to make boot order changes to and press F5/ F6 or +/- to change device boot order.

To select boot order for devices in Legacy Boot Device:

1. When system boots up, press F2 to enter BIOS setup utility
2. Go to **[Boot] > [Legacy Boot Device]**, you can choose the type of device to boot list by selecting “**By Device**” or “**By Device Type**”.
3. Highlight the device or device category you wish to make boot order changes to and press F5/ F6 or +/- to change device boot order.

4.2 AMT Configuration

Intel® AMT (Active Management Technology) is a hardware-based technology for remotely managing target PCs via Ethernet connection. The system supports AMT function via its Ethernet port implemented with Intel I219-LM. Prior to using AMT to remotely control the system, you need to configure AMT password and network settings.

1. Connected Ethernet cable to I219-LM port (indicated in blue).

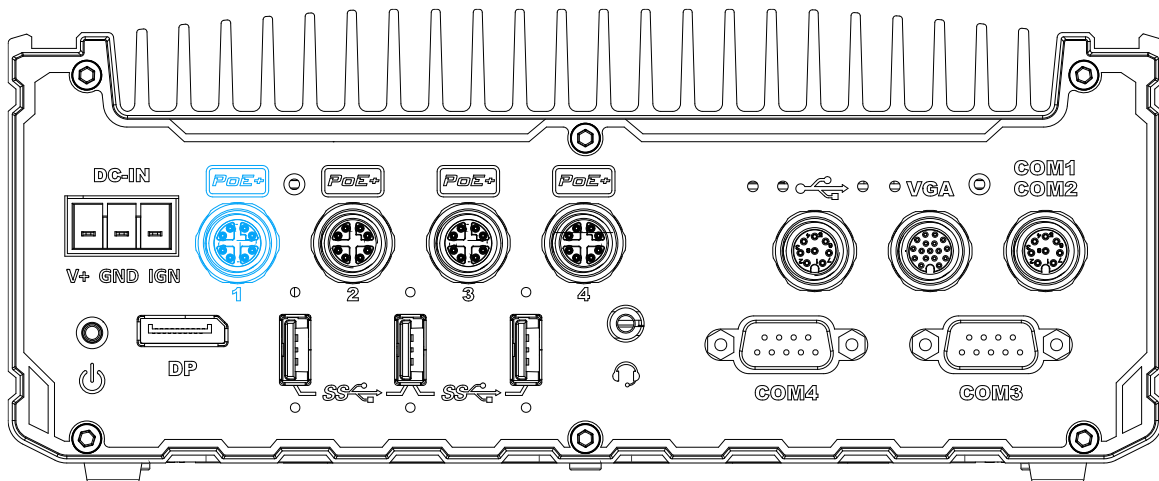

2. When the system boots up, press F10 to enter the MEBx configuration menu.

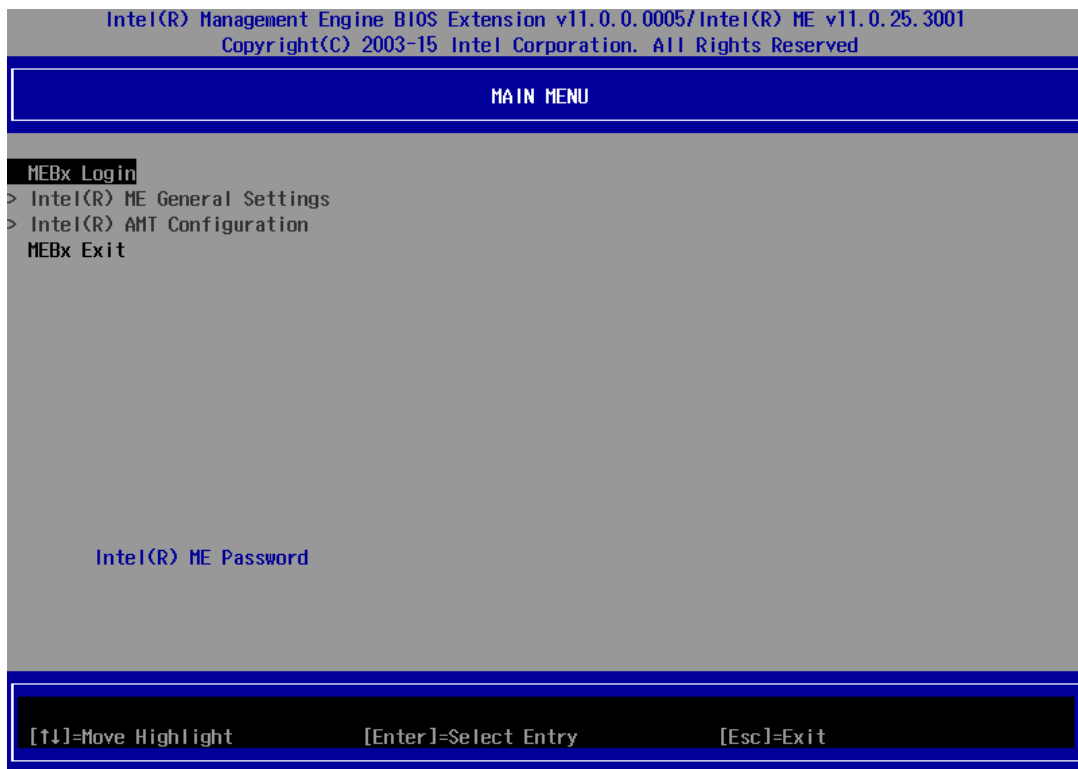

3. Highlight MEBx Login and press Enter, a prompt will appear asking for password. The default password is “admin”. For further MEBx configuration details, please

refer to [Intel® MEBX User Guide](#).

4.3 RAID Volume Configuration

To set up a RAID 0 or 1 volume in Legacy or UEFI mode, you need to have at least two hard drives or SSDs installed. The system supports RAID configurations in RAID 0 (striping) or RAID 1 (mirror) mode. Users can select the configuration that best suit their needs with RAID 0 (striping) mode offering better hard drive read/ write performances while RAID 1 (mirror) offers better data security.



WARNING

Please back up hard drive data before you create or modify RAID volume(s) as the process may cause irreversible data deletion. When creating a RAID volume, it is also recommended to use hard drives from the same batch (same brand, model, capacity, rpm rate, etc.) to avoid performance or capacity allocation issues.

4.3.1 Legacy Mode RAID Configuration

To set up RAID configuration, you need to pre-configure the SATA mode setting in the BIOS. Please refer to the following steps:

1. When system boots up, press **F2** to enter BIOS setup utility.
2. Go to **[Advanced] > [SATA And RST Configuration] > [SATA Mode Selection] >** highlight **[Intel RST Premium With Intel Optane System Acceleration]** and press ENTER.

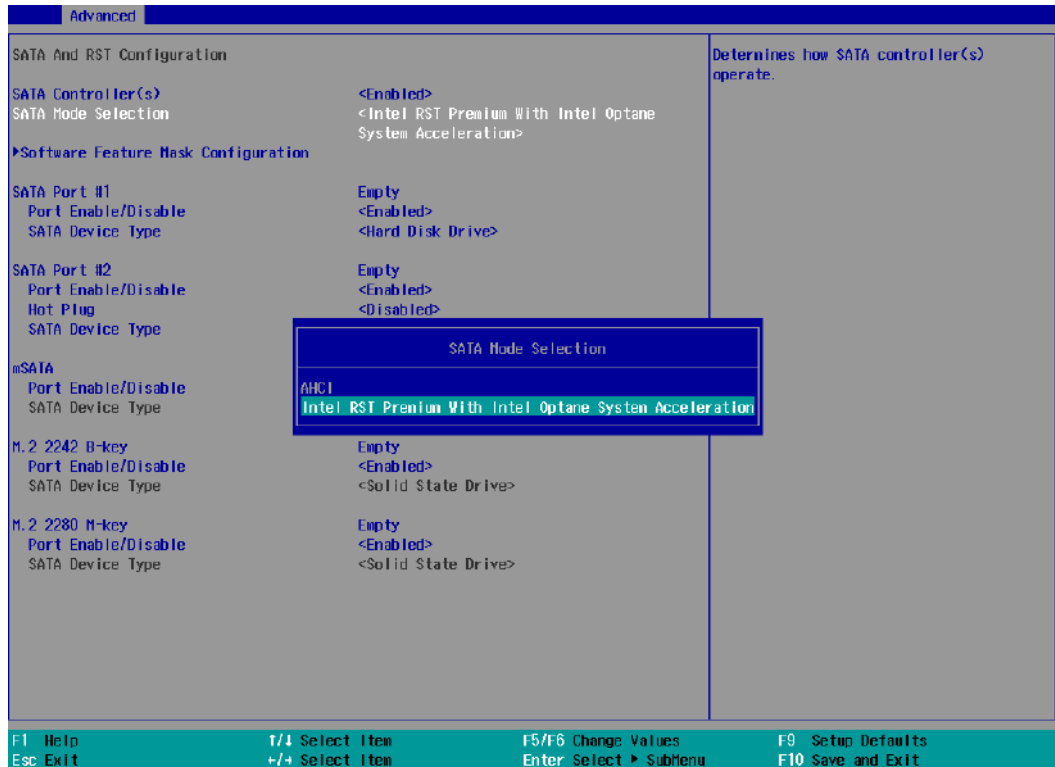

3. Go to [Boot] > highlight [**Legacy Boot Type**] and press ENTER to set boot type.

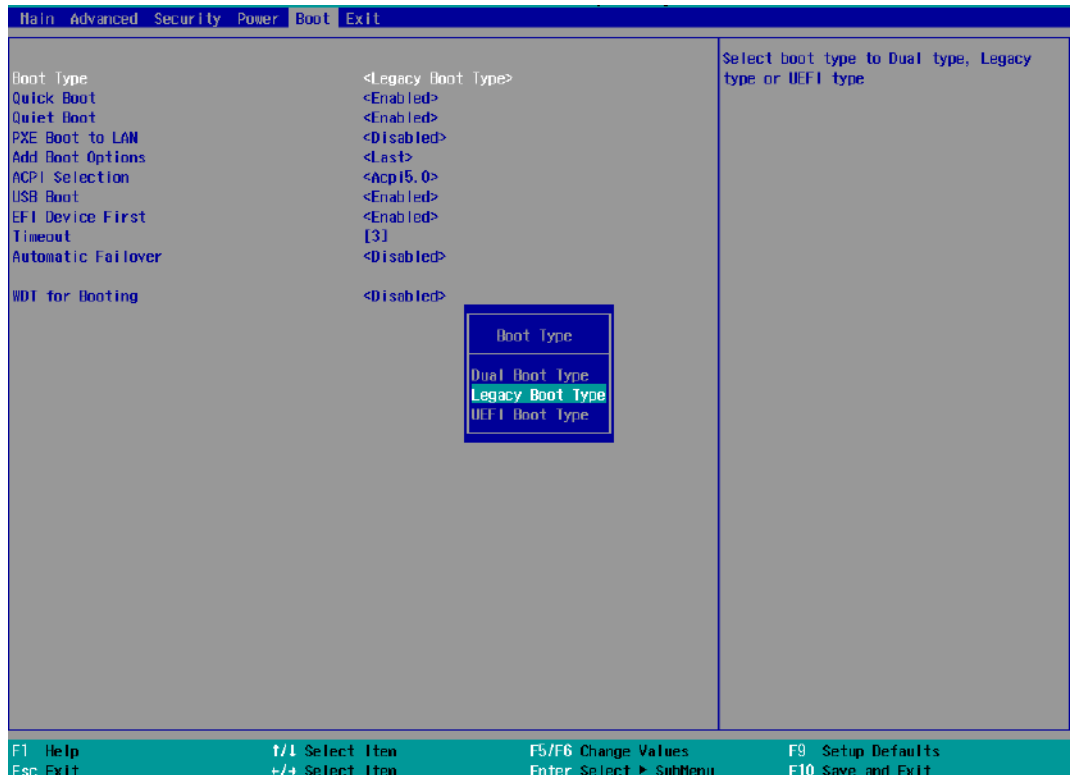

4. Press F10 to "Exit Saving Changes" and reboot the system.
5. When the system reboots, press [**Ctrl + I**] to enter the RAID configuration utility.

- Once you're in the Configuration Utility, highlight **[Create RAID Volume]** and press ENTER.



- The following screen allows you to enter the **Name** of the RAID volume you wish to create. Enter a name and press ENTER to access the **RAID Level** setting.



- For **RAID Level**, use the up and down arrow key to select between **RAID0 (Stripe)** or **RAID1 (Mirror)** settings. Select a RAID mode and press ENTER to access **Stripe Size** setting (not applicable to Mirror mode).

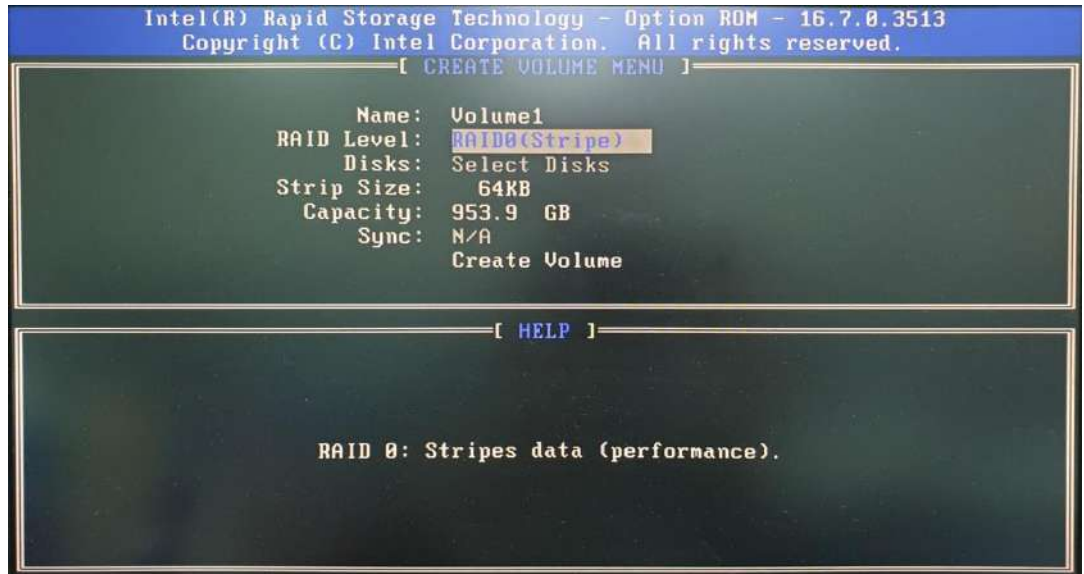

- For **Stripe Size**, use the up and down arrow key to select between 4KB, 8KB, 16KB, 32KB, 64KB, 128KB for your RAID volume stripe size and press ENTER to access the **Capacity** setting.

*RAID1(Mirror) does not offer Stripe Size options.

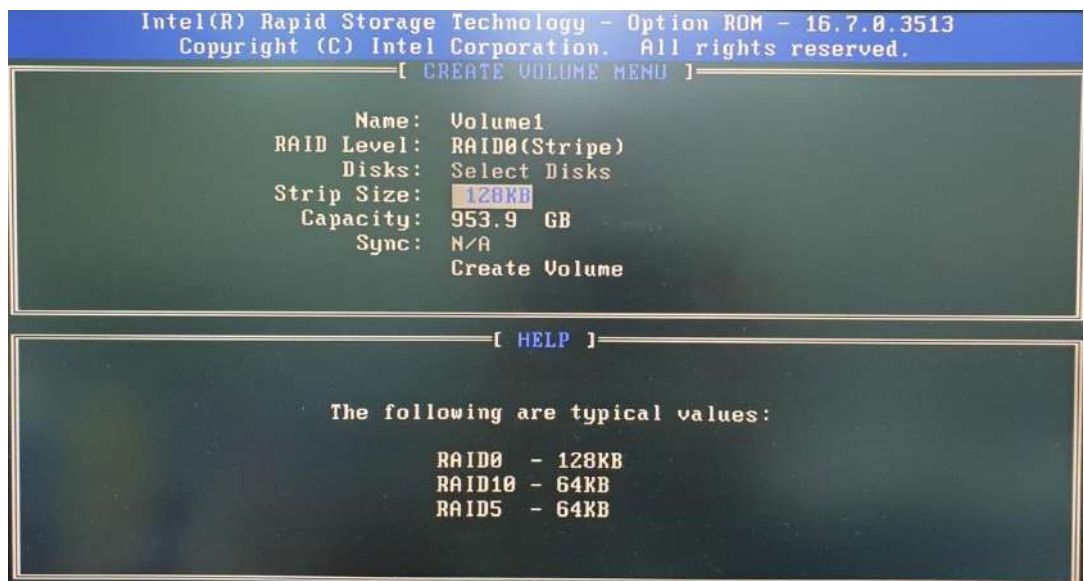

10. You may enter the RAID volume capacity you wish to create at this step and press the Enter key to complete your RAID settings. By default, the maximum capacity will be applied. Once you have entered a capacity, press ENTER to confirm.



11. Reviewed your settings and if you wish to change any setting(s), you will need to press [ESC] and start again from **Step 5**. If all settings are correct and you wish to continue, with “**Create Volume**” highlighted, press ENTER to begin creating the RAID volume.

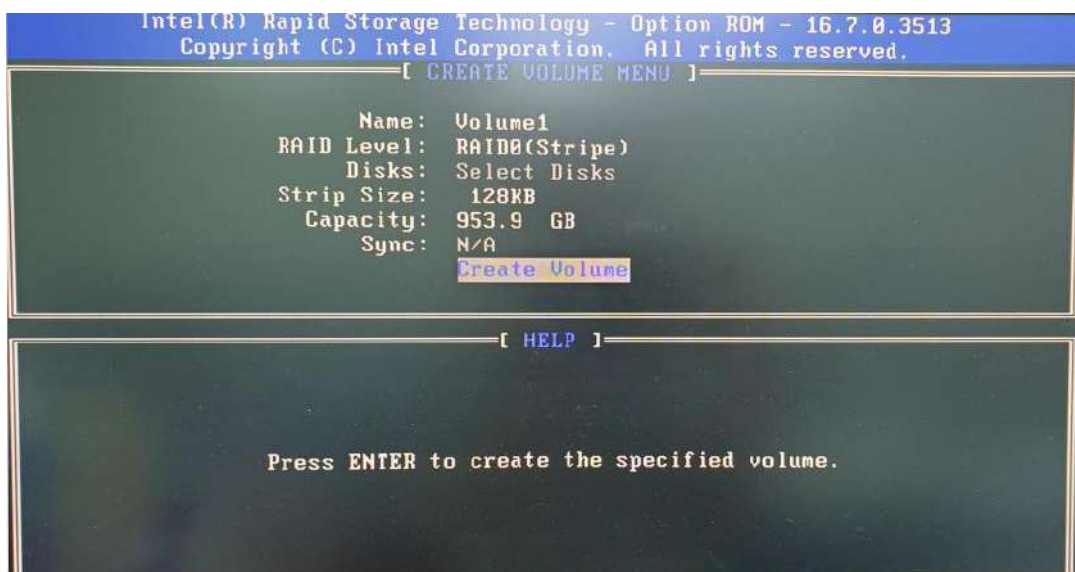

12. A data deletion warning will appear, enter “Y” to continue and “N” to stop the volume creation process.

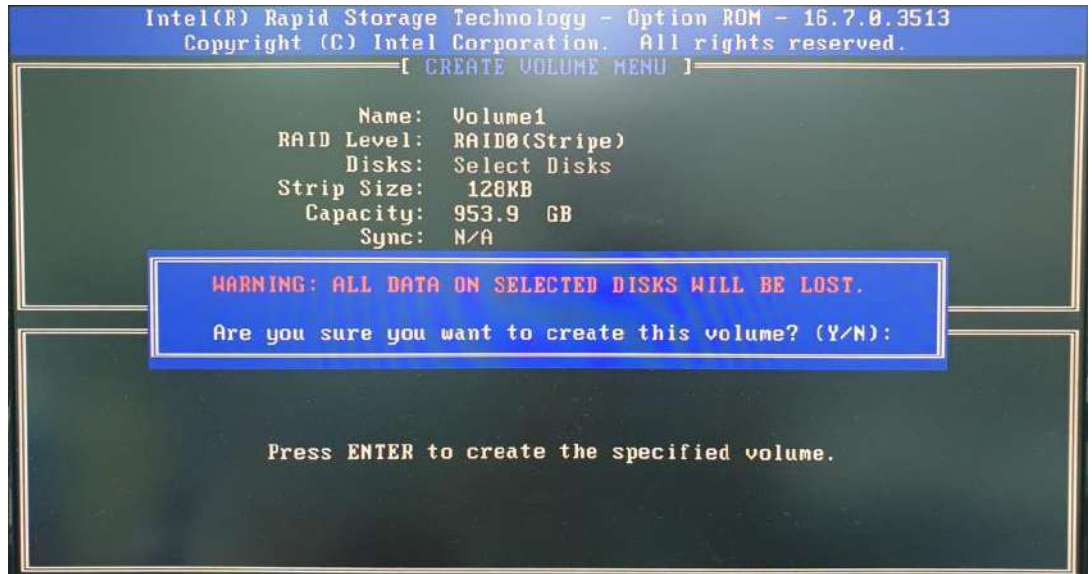

13. Once the RAID volume has been created, the configuration utility will bring you back to the main screen showing the RAID volume and their member disks.

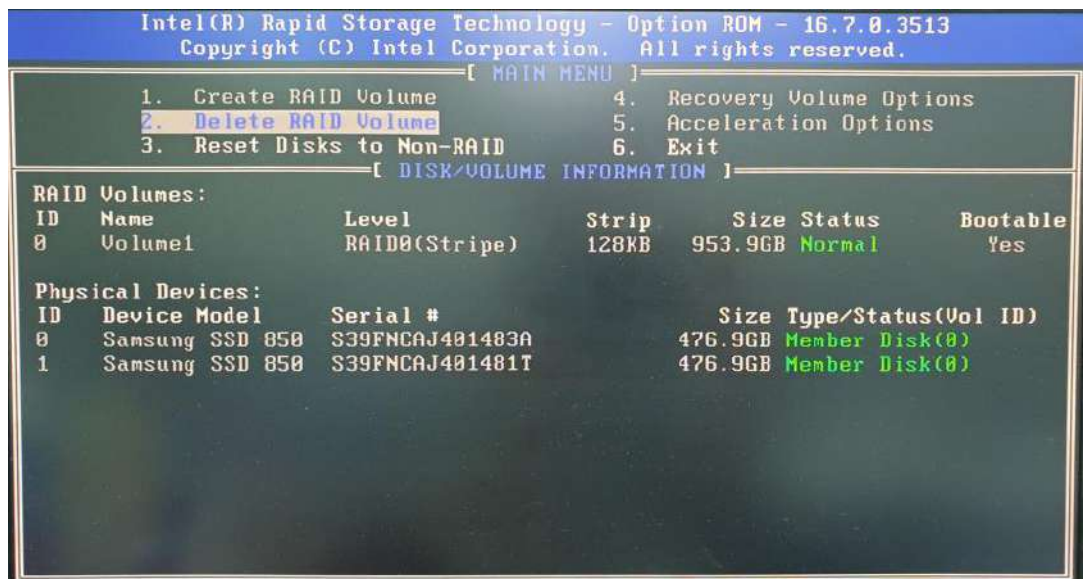

14. The above process was to create a RAID-0 volume. If you wish to create a RAID-1 volume, please perform steps 5 to 13 in this section and select RAID-1 during step 8.

4.3.2 UEFI Mode RAID Configuration

To enable RAID functionality in UEFI mode:

1. When system boots up, press F2 to enter BIOS setup utility.
2. Go to **[Advanced] > [SATA And RST Configuration] > [SATA Mode Selection] >** highlight **[Intel RST Premium With Intel Optane System Acceleration]** and press ENTER.

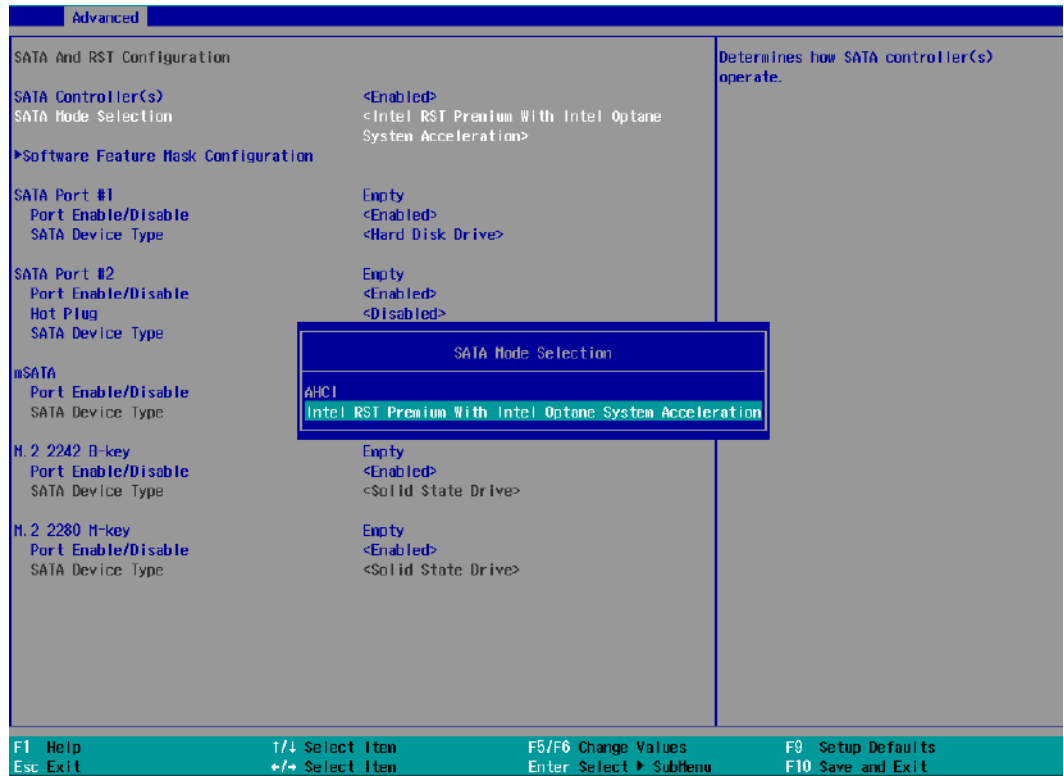

3. Go to **[Boot]**, highlight **[UEFI Boot Type]** and press ENTER to set boot type.

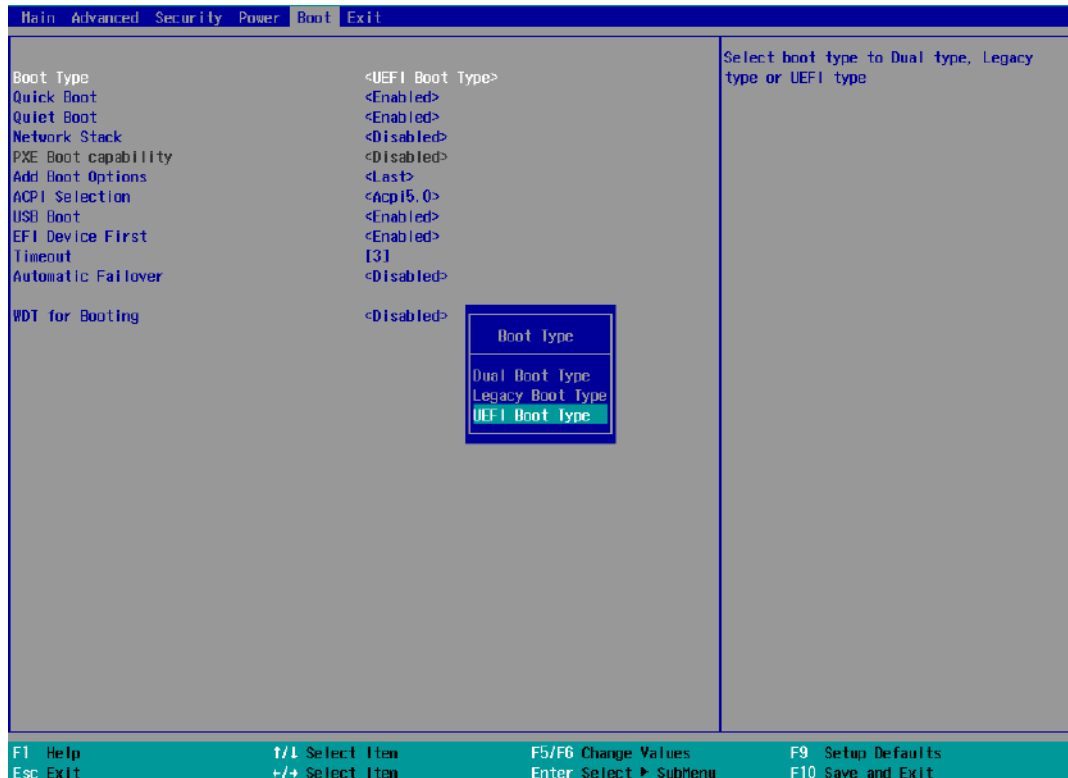

4. Press F10 to “Exit Saving Changes” and reboot the system.
5. When the system reboots, press **[F3]** to enter the Configuration Utility.
6. Once you’re in the Configuration Utility, highlight **[Intel® Rapid Storage Technology]** and press ENTER.



7. The following screen shows Non-RAID physical disks and the option “**Create RAID Volume**”. Highlight “**Create RAID Volume**” and press ENTER to begin creating your RAID volume.

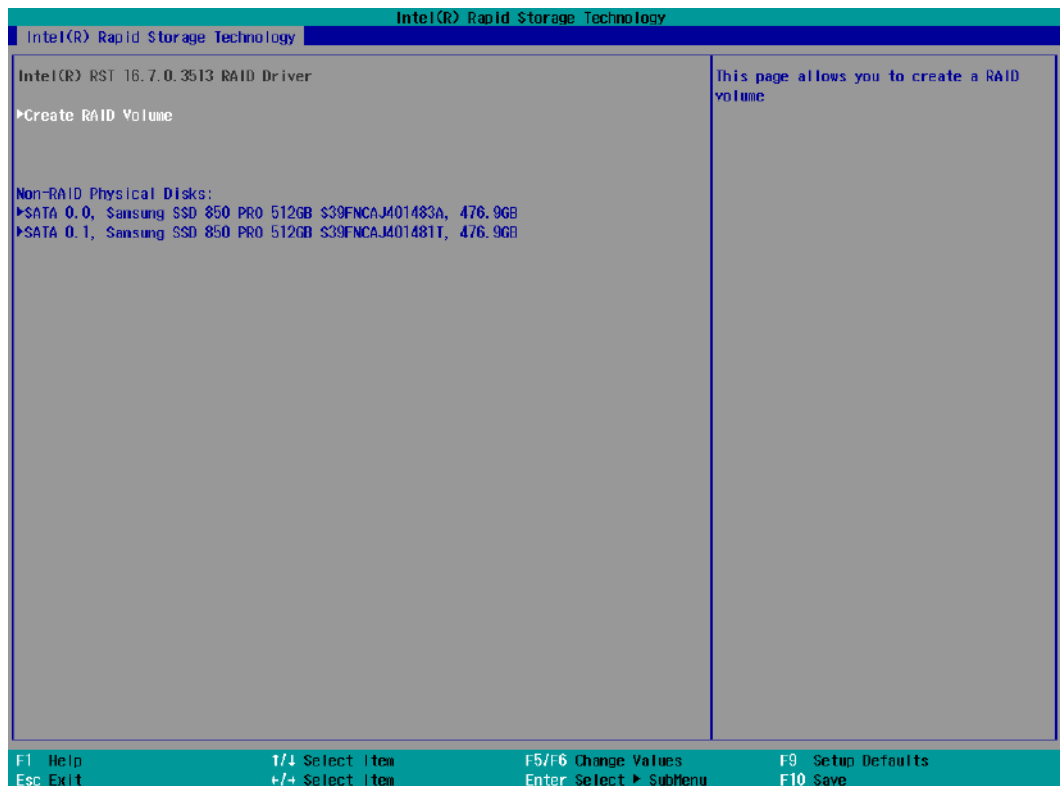

8. The Name option allows you to name your RAID volume. Press ENTER when ready to go to the next option.

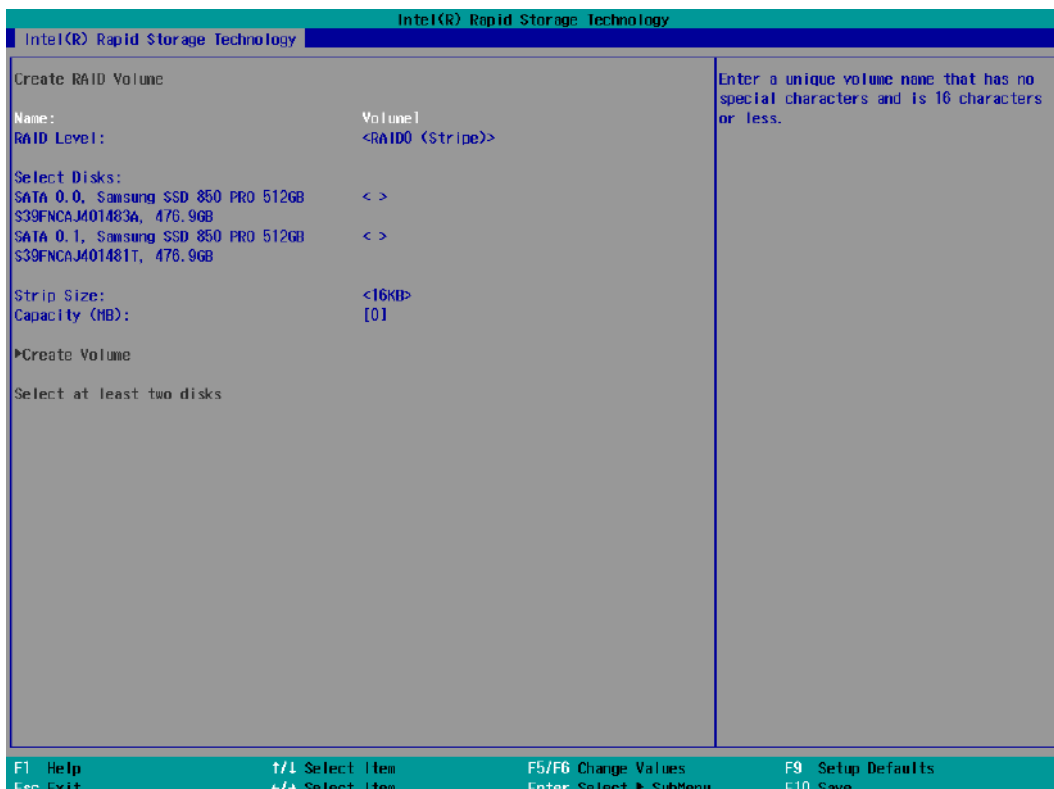

9. The RAID Level option allows you to select RAID-0 (striping) or RAID-1 (mirror) for your RAID volume. Press ENTER when ready.

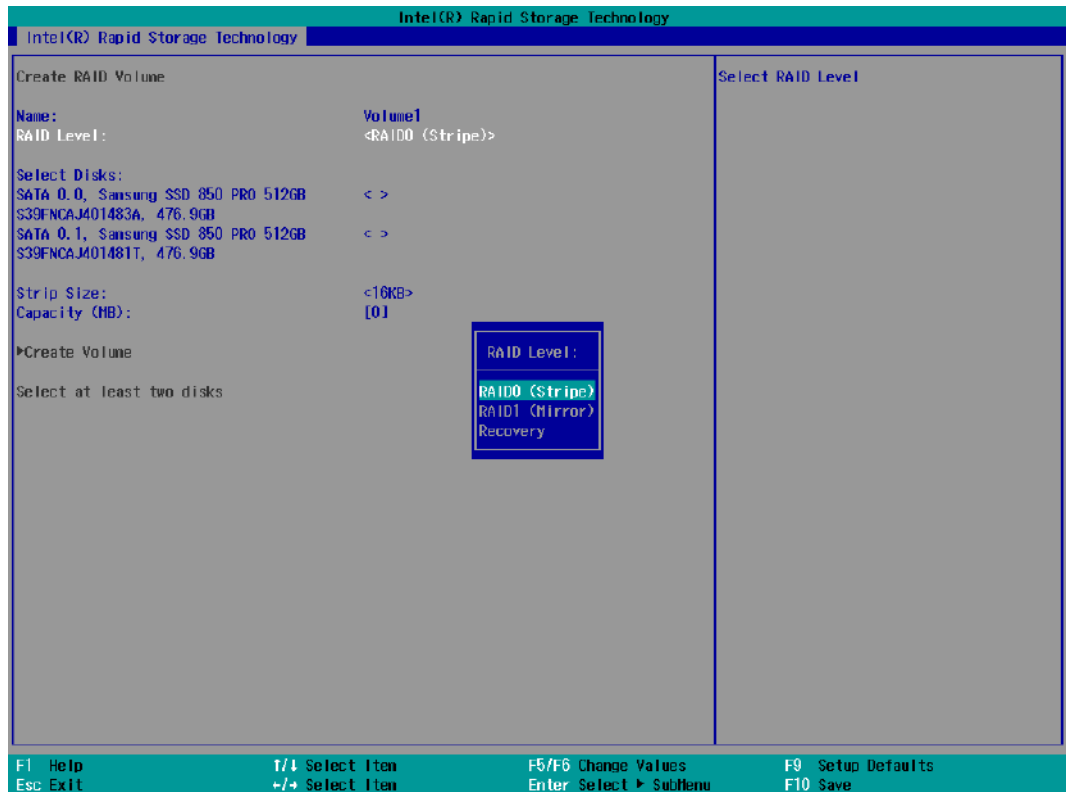

10. The Select Disks option allows you to select disk drives for your RAID volume. Highlight a drive and press ENTER, use up/ down arrow keys to highlight "x" and press ENTER to confirm the selection. A minimum of two disk drives must be selected for RAID-0 or RAID-1 configuration. Press ENTER when ready.

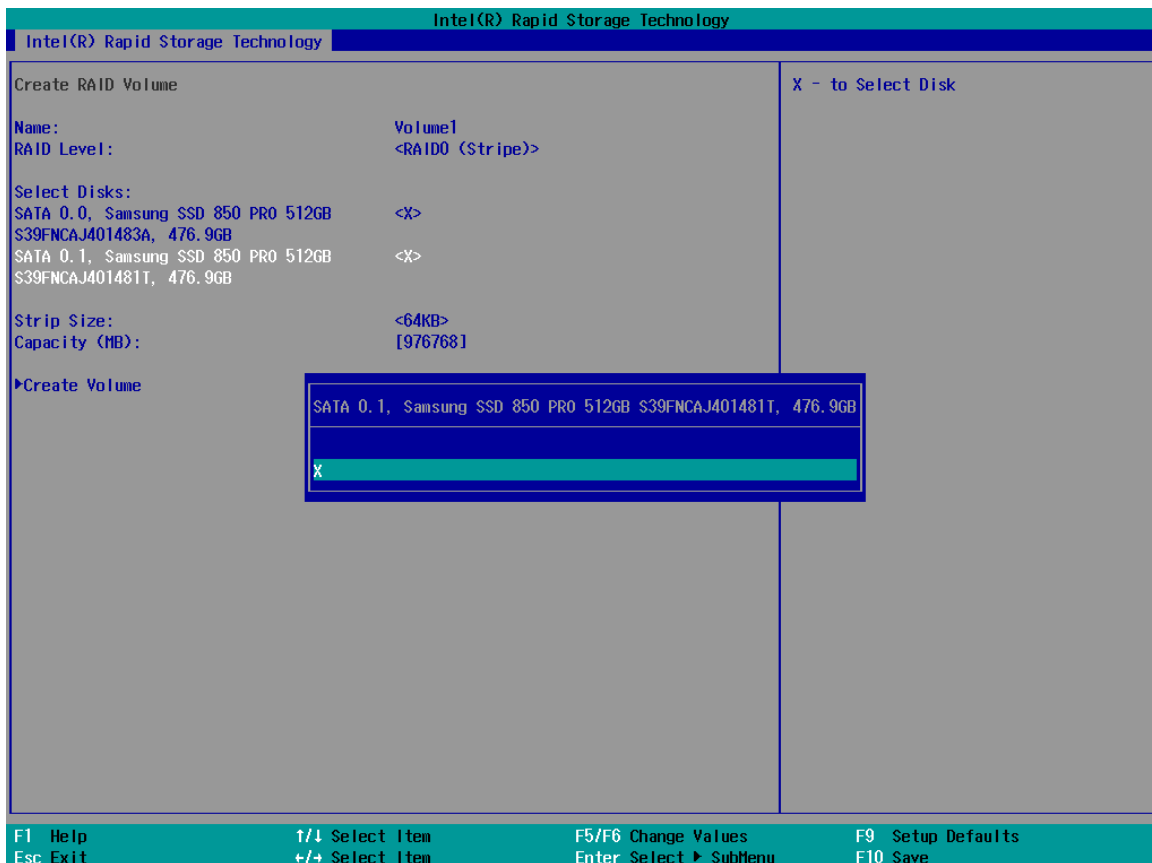

11. The Stripe Size option allows you to configure the stripe size of your RAID volume. Available stripe sizes are 4KB, 8KB, 16KB, 32KB, 64KB, 128KB, use the up and down arrow keys to highlight and press ENTER to confirm the stripe size selection.

*RAID1(Mirror) does not offer Stripe Size options.

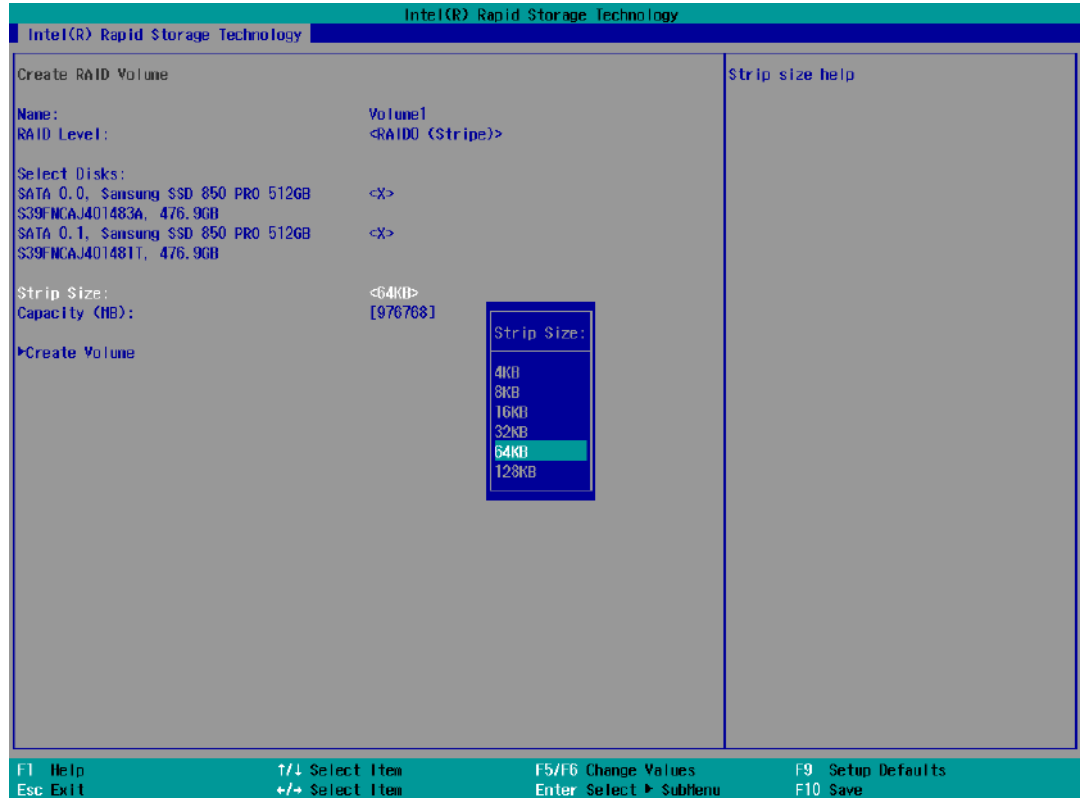

- The Capacity (MB) option allows you to configure the storage capacity of your RAID volume. By default, the full storage capacity will be applied. Once you have entered a capacity, press ENTER to confirm.



- The Create Volume option is the final step in the volume creation process. Highlight **“Create Volume”** and press ENTER to begin creating your RAID volume base on the settings you just configured.

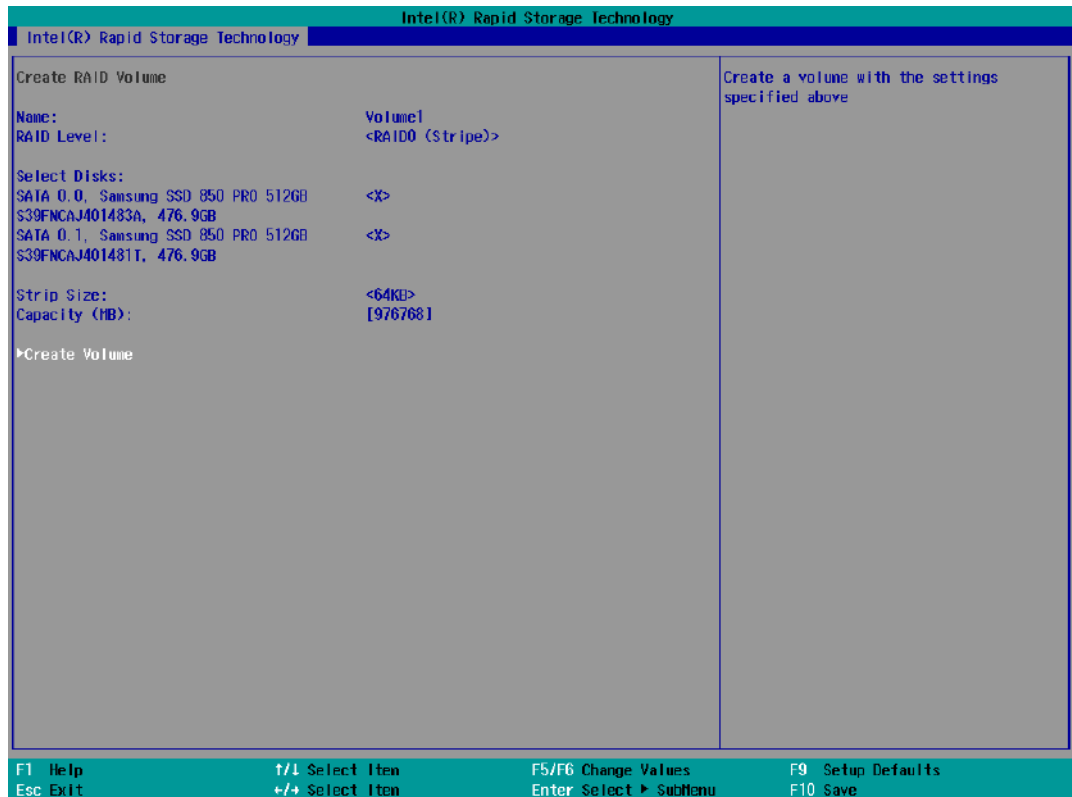

14. A summary and status of the RAID volume will be shown when the RAID volume is successfully created.

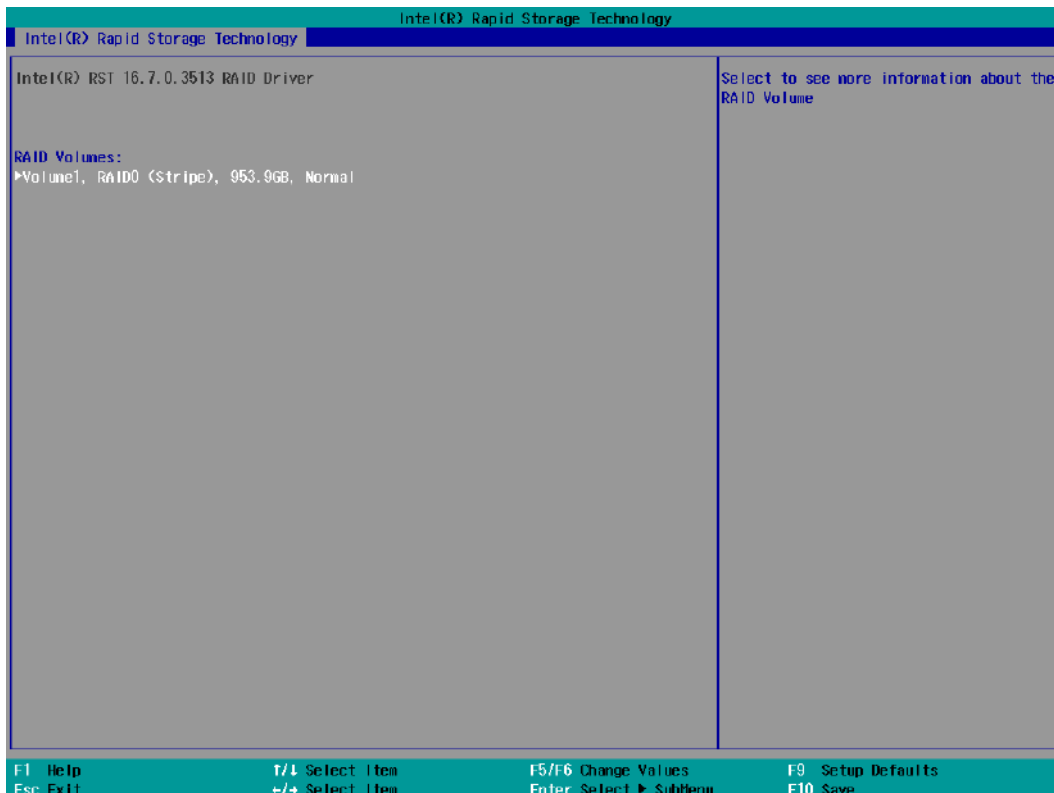

15. Press F10 to save and Esc to exit the Intel® Rapid Storage Technology configuration page.



NOTE

The above process was to create a RAID-0 volume. If you wish to create a RAID-1 volume, please perform steps 5 to 13 in this section and select RAID-1 during step 9.

5 OS Support and Driver Installation

5.1 Operating System Compatibility

The system support most operating system developed for Intel® x86 architecture. The following list contains the operating systems which have been tested by Neosys Technology.

- Microsoft Window 10 (x64)
- Fedora 29**
- Ubuntu 16.04.5 LTS** & Ubuntu18.04.0 LTS**



NOTE

For other Linux OS, Linux kernel should upgrade to 4.15.18.

**For Linux system, user may need to manually compile and install the driver for Intel graphics or I210 GbE controller if the driver is not embedded in kernel. You can visit Intel website for further information.*

***For distributions, graphics driver and RAID function may not be completely implemented in its kernel. You may encounter restrictions when using these features, such as triple independent display and RAID. For optimum operation, it is the users' responsibility to manually check for new drivers and upgrades!*

Neosys may remove or update operating system compatibility without prior notice. Please contact us if your operating system of choice is not on the list.

5.2 Install Drivers Automatically

The system comes with a “Drivers & Utilities” DVD that offers “one-click” driver installation process. It automatically detects your Windows operating system and installs all necessary drivers for you system with a single click.

5.2.1 Install Drivers Automatically

To install drivers automatically, please refer to the following procedures.

1. Insert the “Drivers & Utilities” DVD into a USB DVD-drive connect to your system. A setup utility launches and the following dialog appears.



2. Click on “**Automatic Driver Installation**” and the setup utility will automatically detect your Windows operating system and install all necessary drivers. The installation process takes about 6~8 minutes depending on your Windows version. Once driver installation is done, the setup utility reboots your Windows and you may begin using your system.

5.3 Install Drivers Manually

You can also manually install each driver for the system. Please note when installing drivers manually, you need to install the drivers in the following sequence mentioned below.

5.3.1 For Windows 10 (x64)

The recommended driver installation sequence is

1. Chipset driver (x:\Driver_Pool\Chipset_CFL\Win_10_64\SetupChipset.exe)
2. Graphics driver (x:\Driver_Pool\Graphics_CFL_SKL_APL\Win_10_64\igxpin.exe)
3. Audio driver (x:\Driver_Pool\Audio_ALC262\Win_ALL_64\Setup.exe)
4. LAN driver
(x:\Driver_Pool\GbE_I210_I350\Win_10_64_CFL\APPS\PROSETDX\Winx64\DxSetup.exe)
5. ME driver (x:\Driver_Pool\ME_CFL\Win_10_64\SetupME.exe)

5.4 Driver Installation for Watchdog Timer Control

Neosys provides a driver package which contains function APIs for watchdog timer, digital I/ O, per-port PoE power on/off control and other platform-related functions. You should install the driver package (WDT_DIO_Setup.exe) in prior to use these functions.

Windows 10 (x64)

Please execute the driver setup program in the following directory.

x:\Driver_Pool\WDT_DIO\Win7_8_10_64\WDT_DIO_Setup_v2.2.9.x(x64).exe

Windows 10 (WOW64)

Please execute the driver setup program in the following directory.

x:\Driver_Pool\WDT_DIO\Win7_8_10_WOW64\WDT_DIO_Setup_v2.2.9.x(wow64).exe

5.5 Intel® Optane™ Memory BIOS Setup and Driver

Installation

The system is compatible with Intel® Rapid Storage Technology that supports the installation of Intel® Optane™ memory to significantly boost traditional hard disk drive read and write performances. Intel® Optane™ memory is Intel® RST's latest system acceleration solution featuring a dual-media/disk combination (ultrafast media for file and block caching + slow media for storage capacity) that is presented to the host OS as a single SSD. The ultrafast media utilizes PCIe NVMe SSDs that are based on Intel® Optane™ technology with read speed of up to 3000Mb/ sec and write speed of up to 2000Mb/ sec.

To setup Intel® Optane™ memory, please perform the following steps:

1. Press the power button to startup your system (please restart if your system is already up and running) and press F2 to enter BIOS.
2. Go to "Advanced > SATA And RST Configuration".

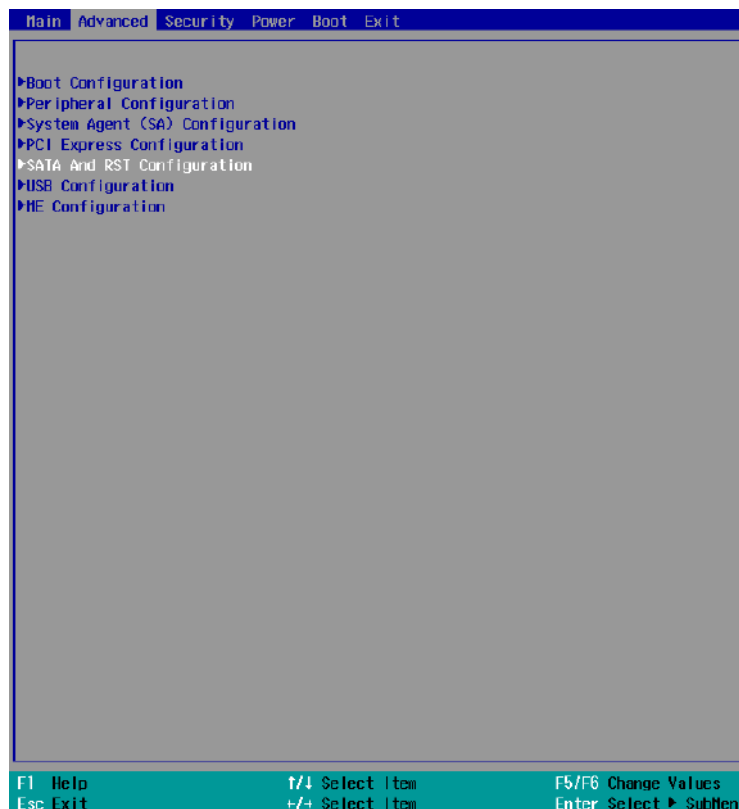

- Go to “SATA Mode Selection”, press the Enter key to bring up options, select “Intel RST Premium With Intel Optane System Acceleration” and press ENTER to select the option.

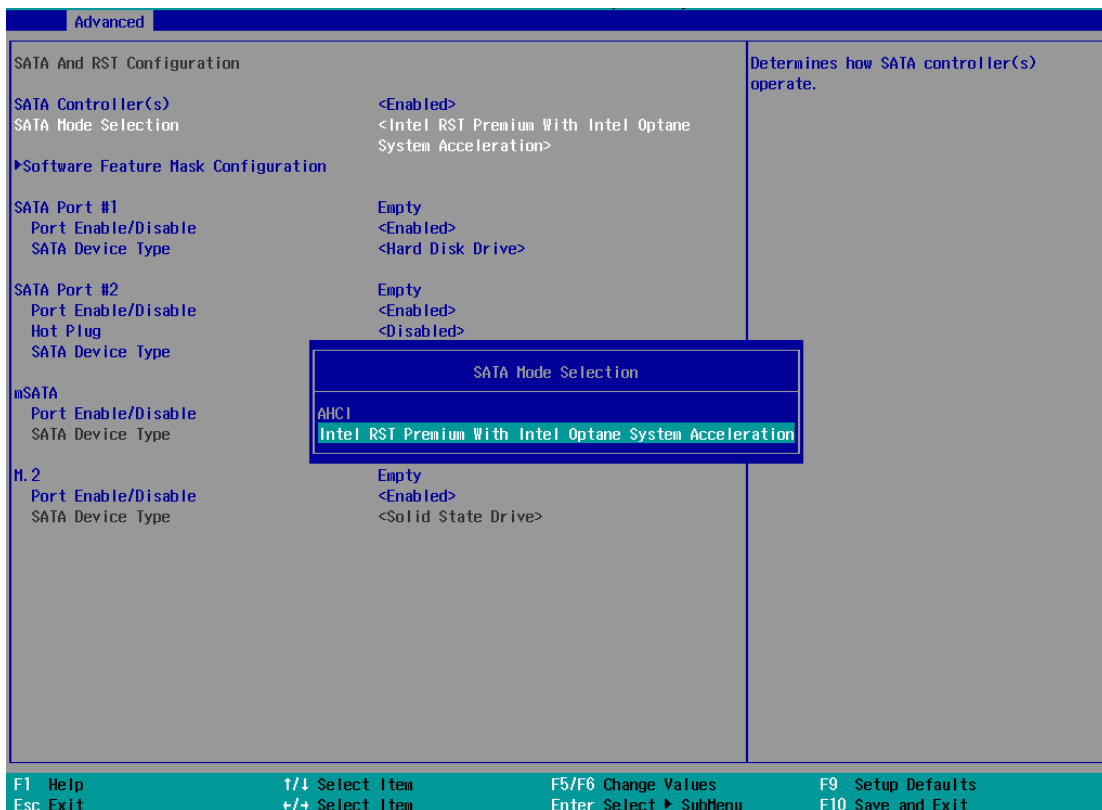

4. Go to “M.2 2280 NVMe Storage Device” and press the Enter key to bring up the selection, select “RST Controlled” and press the Enter key to select the option.



5. Press F10 to save and exit, and allow the system to boot into Windows.
6. In Windows, download [Intel® RST driver](#) if you don't already have it on hand.



Right-click on the SetupOptaneMemory.exe and left-click on “Run as administrator” to execute the setup file.

- 7. Follow the 6 step setup procedure as instructed.

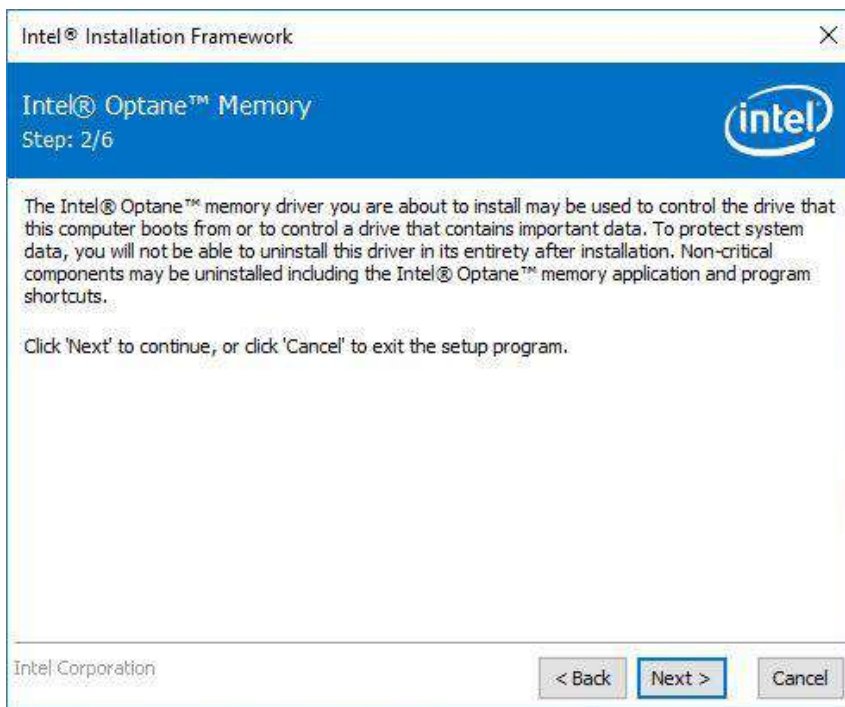
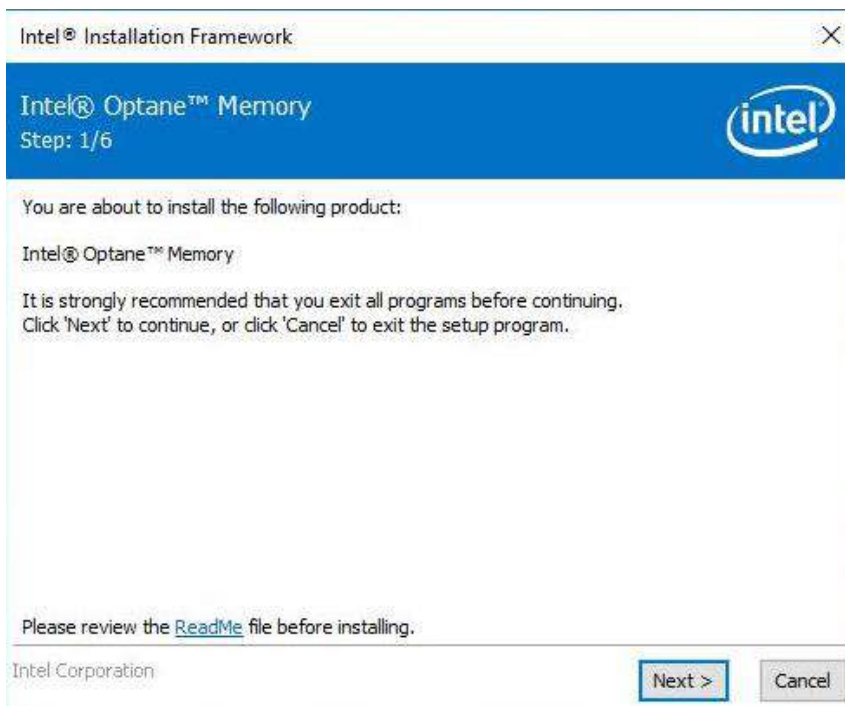

8. Check the "I accept the terms in the License Agreement" box and click on "Next >" to continue the installation process.

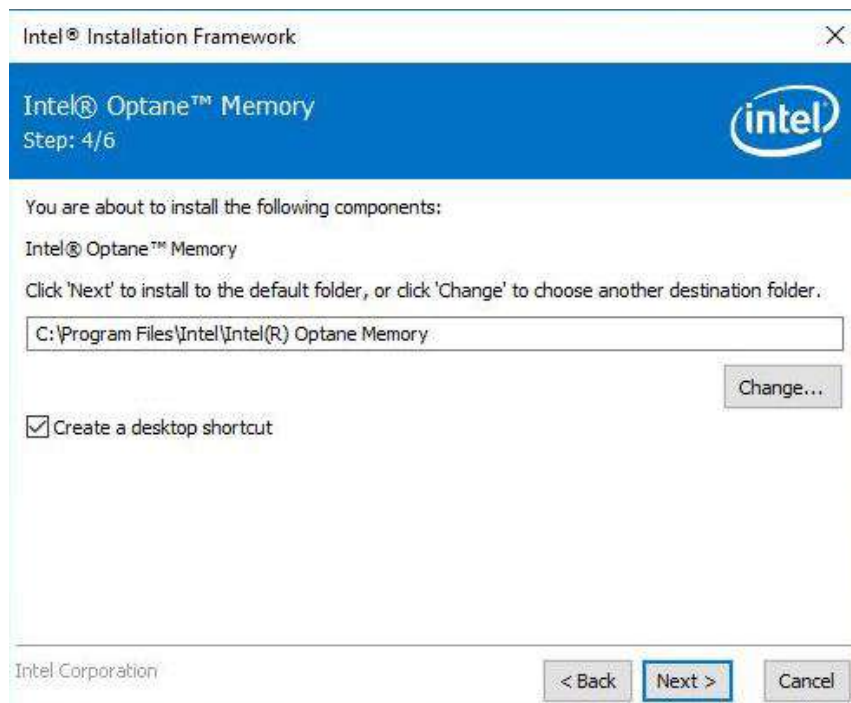
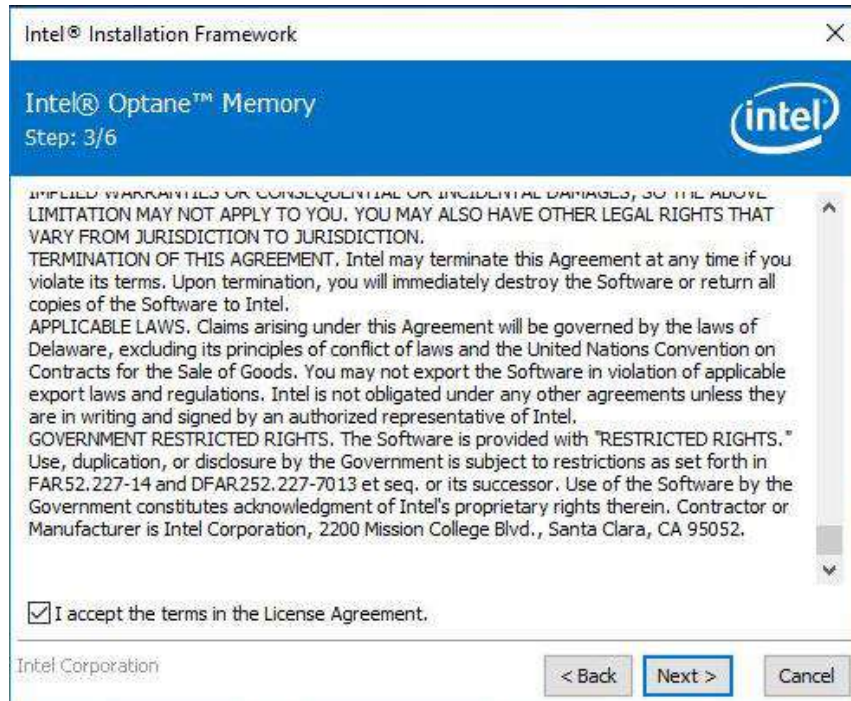

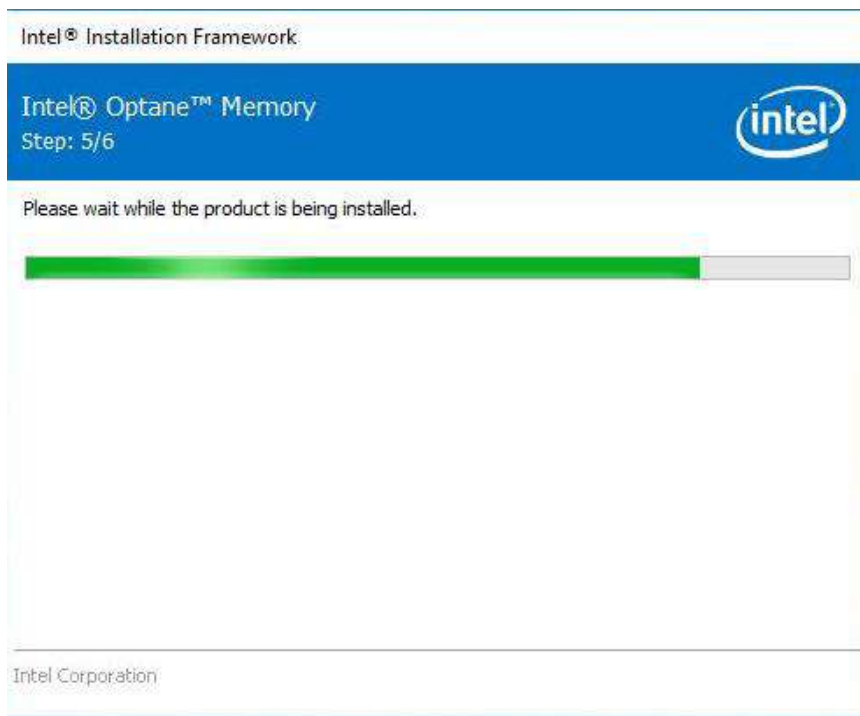

- 9. When done, click on "Finish" and restart the system.

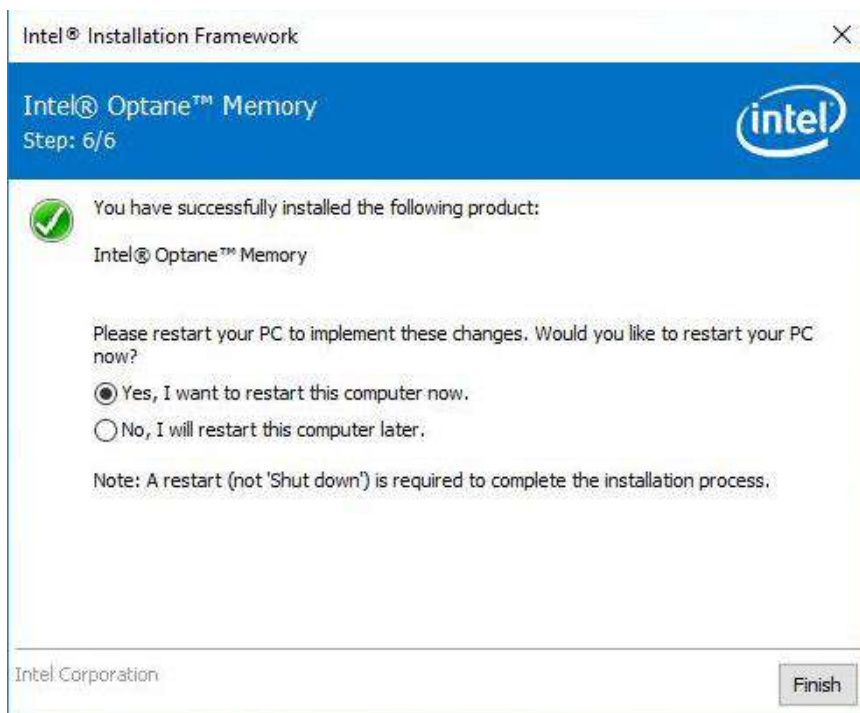

- Upon system restart, the following initialization screen will appear. Click on Next to continue.

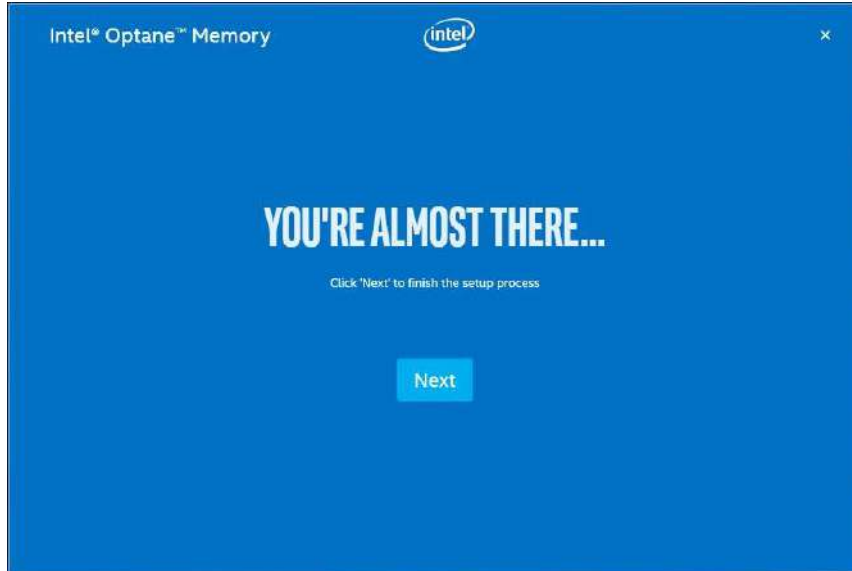

- In the Setup section, you will see your Intel® Optane™ memory drive and compatible drive(s) that can be accelerated. Click on the downward arrow to bring up a selection of drives to be accelerated. Click on “Enable” when ready.

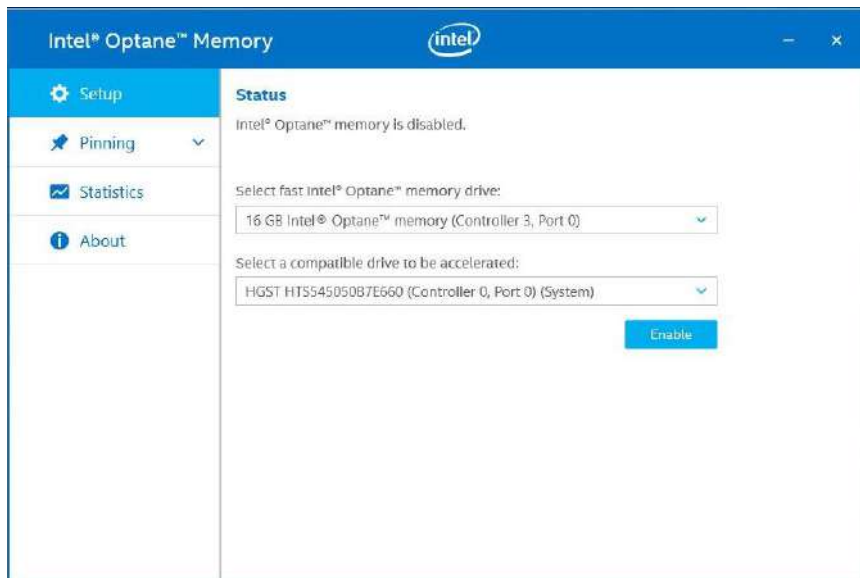

- The data backup warning will appear, please backup any data you may have stored on your Intel® Optane™ memory module before proceeding. Check the box “Erase all data on Intel® Optane™ memory module” and click on Continue.

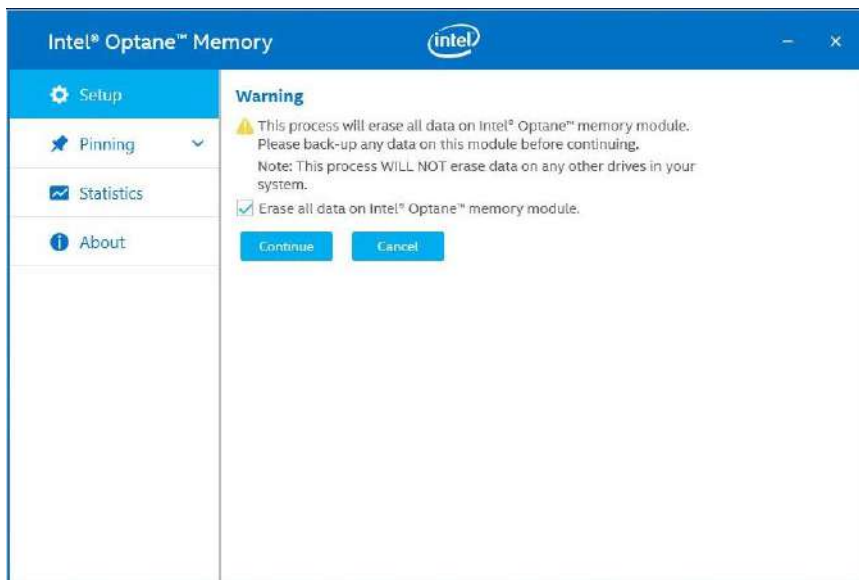

- When the Intel® Optane™ memory module has been enabled, the installation window and a notification window at the bottom right corner will prompt you to restart the system.

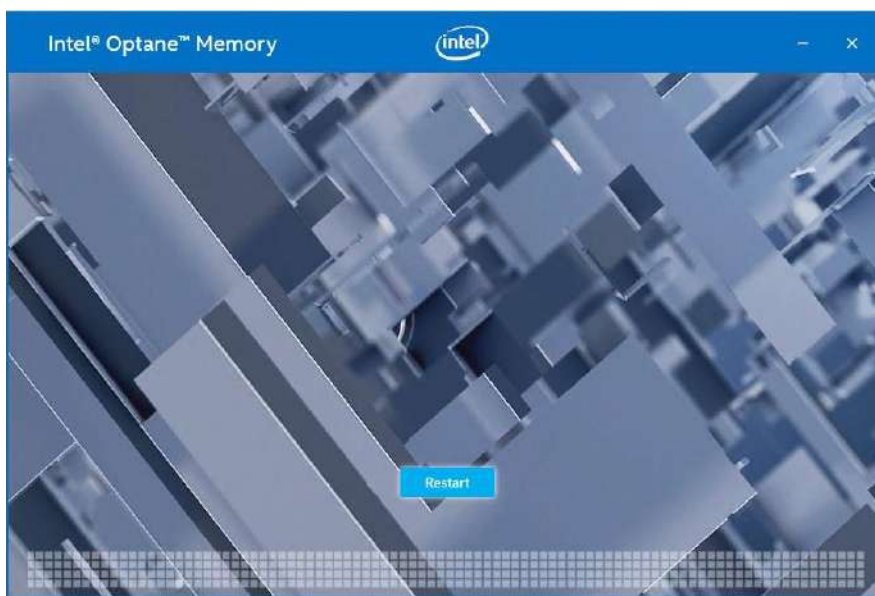

- Upon system restart, a successful enablement message will appear to indicate the Intel® Optane™ memory module has been enable successfully.

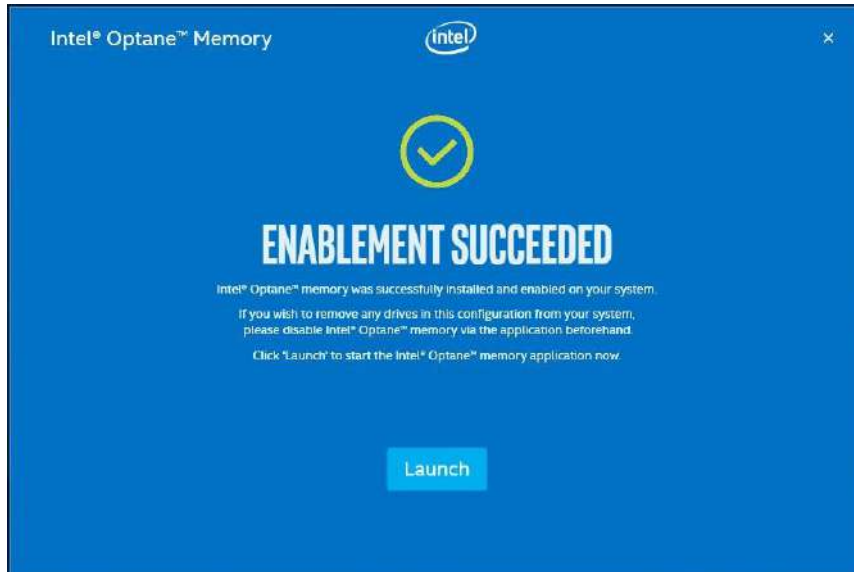

- Once enabled, the RST software Setup section should show your configuration information.

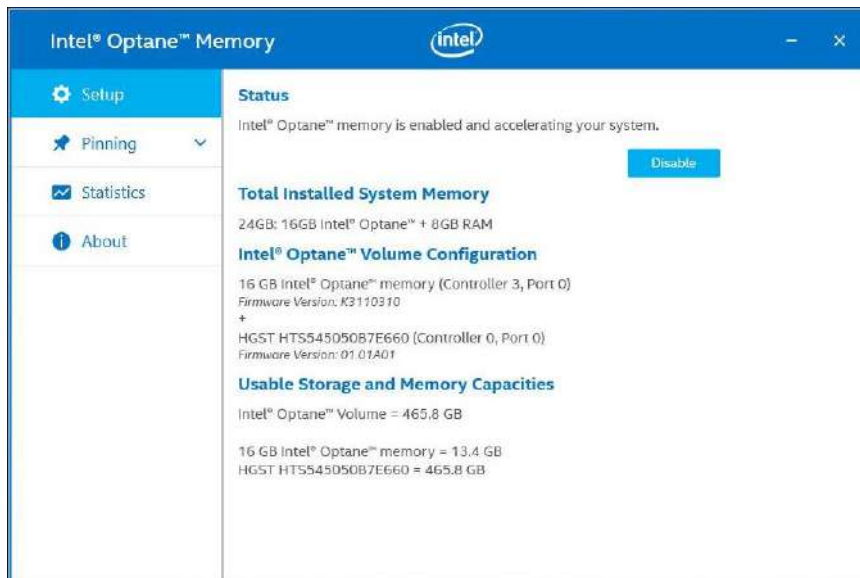

6 CAP Energy Management Technology ~ Power

Backup Parameter Configurer

By controlling fundamental techniques such as charge/ discharge control, active load balance and DC/ DC regulation, Neousys is able to design and create a reliable ultracapacitor-based power backup system. However, the real challenge is how to get the most out of the capacitor energy while ensuring the system shuts down safely during a power blackout.

6.1 CAP Energy Management Technology

The patented architecture (R.O.C. patent I598820) incorporates a microprocessor along with supercapacitors and charge/ discharge controller. The proprietary firmware embedded in the MCU not only monitors energy level continuously, it also automatically initiates soft-shutdown to prevent data loss/ corruption.

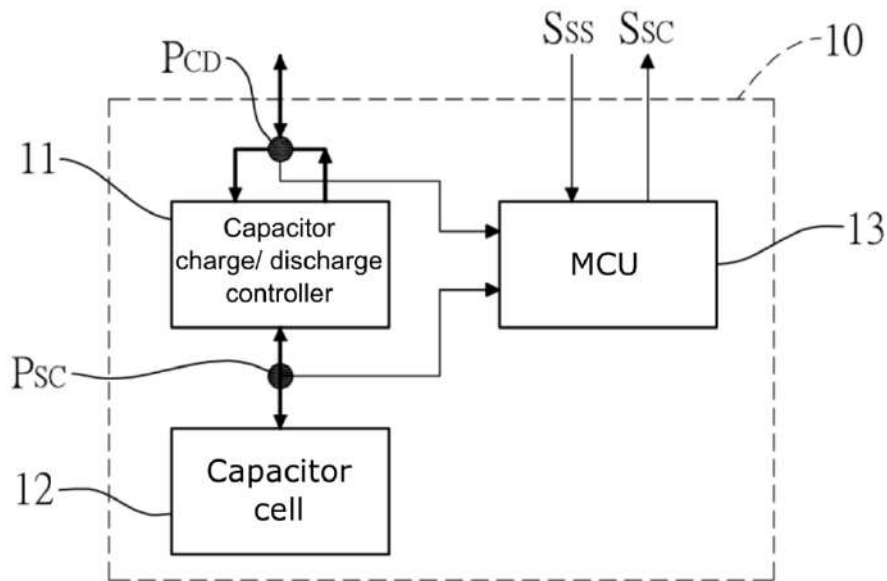

By providing sophisticated real-time energy monitoring, high/ low voltage protection and auto/ manual shutdown control, the dedicated interface help users better manage and efficiently utilize their PB standalone module. The software can also extend the lifespan of supercapacitors up to 4.8x by controlling charge/ discharge cycles.

6.2 Power Backup Parameter Configurer

6.2.1 Executing PB2500J Parameter Configurer

The PB2500J Parameter Configurer is an application that allows the user to monitor and manage the connected PB2500J-PCIe/ CSM.

Once you have installed PB2500J-PCIe/ CSM and have connected it to the host controller COM5 port (configured in RS-232 mode). You may copy the “PB2500J_Configurer” executable (.exe) file on the Utility DVD to your computer desktop and run it by right-clicking on the exe file and select to “Run as administrator” from your desktop (installation not required).

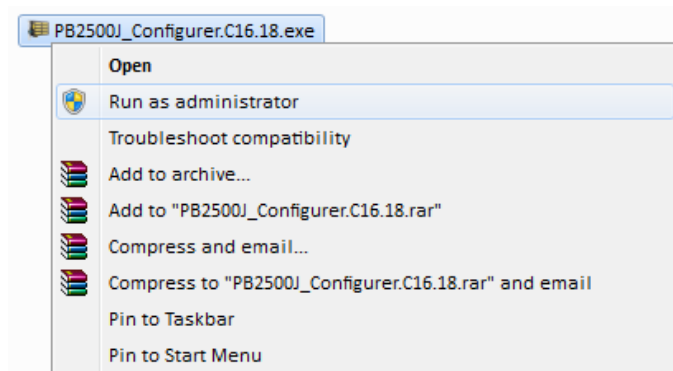

6.2.2 PB-2500J Parameter Configurer

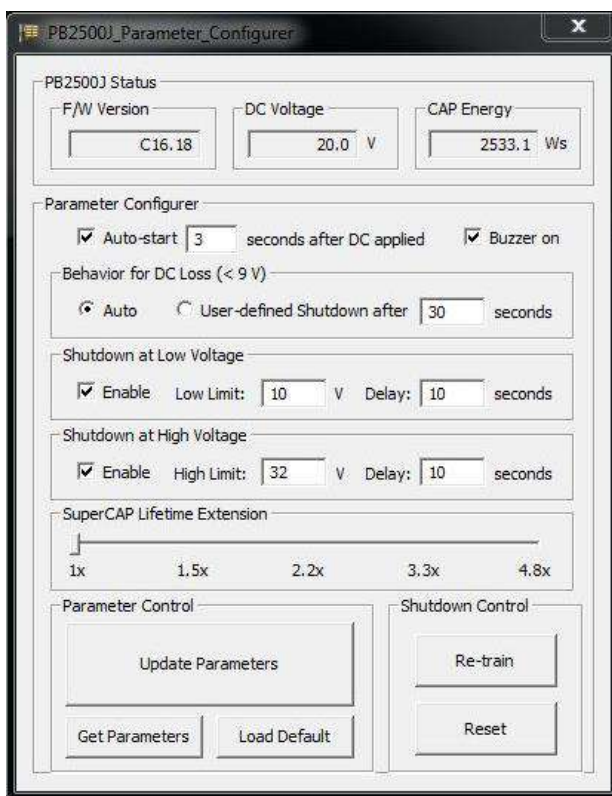

Item	Description	
F/W Version	Shows the firmware version of your PB-2500J	
DC Voltage	Shows the current input voltage of your PB-2500J	
CAP Energy	Shows the current charged energy status (rated 2500Ws Max.)	
Parameter Configurer	Auto-start _ seconds after DC applied	The time delay (in seconds) to start PB-2500J once your computer has been powered on.
	Behavior for DC Loss (<9V)	This allows you to set the delay time (in seconds) to shutdown when DC voltage drops below 9V.
	Shutdown at Low Voltage	This allows you set the low voltage limit and delay time (in seconds) to shutdown (Note: DO NOT set voltage lower than 10V)
	Shutdown at High Voltage	This allows you set the high voltage limit and delay time (in seconds) to shutdown (Note: DO NOT set voltage higher than 32V)
	SuperCAP Lifetime Extension	This setting allows you to extend the lifespan of the Supercapacitors on your PB-2500J. Lifespan extension settings are approximate figures and may not exactly reflect real world applications.
	Parameter Control	Update Parameters: Click on this button for new parameters to take effect. Get Parameters: Click on this button to acquire current parameters. Load Default: Clicking on this button to load default parameters.
	Shutdown Control	Re-train: This button will re-train PB-2500J to be customized to the system's required shutdown time. Reset: This button will reset (erase) previous Re-train shutdown settings.

6.2.3 Auto-start

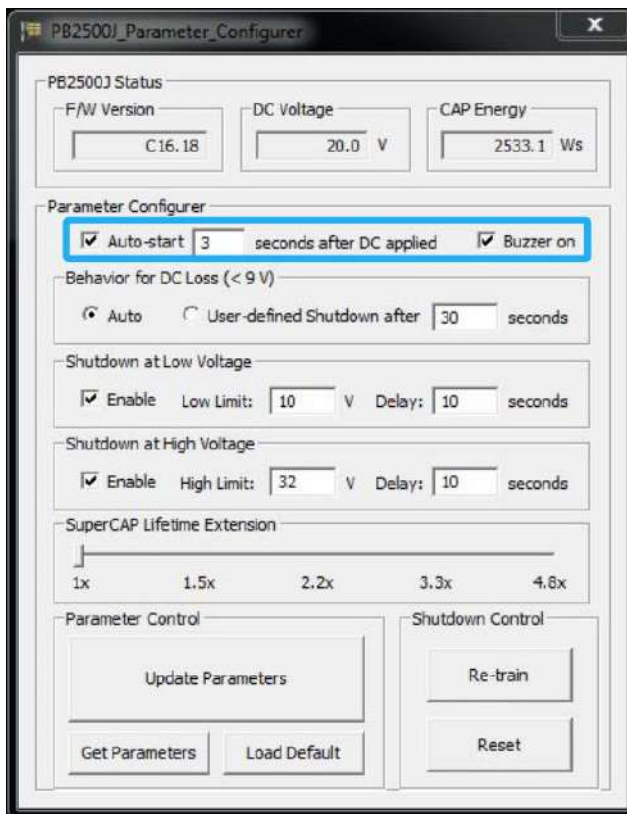

Auto-start Settings

<p>Auto-start _ seconds after DC applied</p>	<p>If the “Auto-start” box is checked, the system will start __ seconds after the 3-pin pluggable terminal block is plugged into the system (DC applied).</p> <p>If the “Auto-start” box is not checked, once you have plugged in the 3-pin pluggable terminal block, you will need to press the power button to turn the system on.</p>
<p>Buzzer on</p>	<p>If the “Buzzer on” box is checked, a buzzer sound will sound as soon as the supercapacitors start to discharge (supplying power to the system).</p> <p>If the “Buzzer on” box is not checked, no buzzer sound will be made when the supercapacitors start to discharge.</p>



NOTE

For new parameters to take effect, you must click on “[Update Parameters](#)” and follow procedure instructions. Please refer to the relevant section for details.

6.2.4 Behavior for DC Loss (<9V)

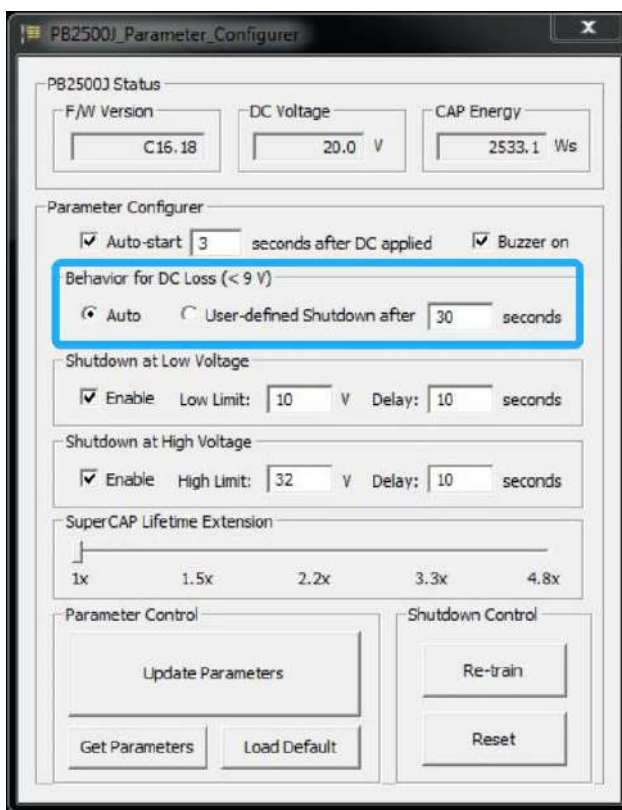

Behavior for DC Loss (<9V) Settings

Auto	If the “ Auto ” box is selected, the delay shutdown time will be pre-determined by the MCU when you “Re-train” PB-2500J.
User-defined Shutdown after _ seconds	If the “ User-defined Shutdown after _ seconds ” is selected, when the input voltage drops below 9V, the shutdown process will be initiated by the user defined time in seconds.



NOTE

For new parameters to take effect, you must click on “[Update Parameters](#)” and follow procedure instructions. Please refer to the relevant section for details.

6.2.5 Shutdown at Low Voltage

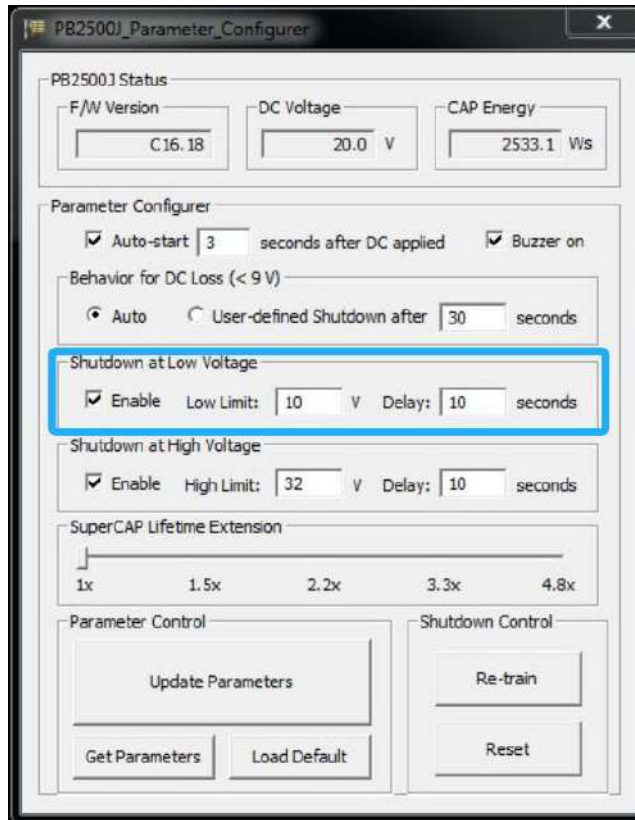

Shutdown at low voltage settings

Enable	If the “ Enable ” box is checked, the shutdown process will be determined by the Low Limit: _ V and Delay: _ seconds settings.
Low Limit: _ V	If the “ Enable ” box is checked, the shutdown process will be initiated by low voltage limit setting (Low Limit: _ V) and the Delay: _ seconds.
Delay: _ seconds	If the “ Enable ” box is checked, the shutdown process will be initiated in _ seconds (Delay: _ seconds) when the low voltage limit setting (Low Limit: _ V) is reached.



NOTE

For new parameters to take effect, you must click on “[Update Parameters](#)” and follow procedure instructions. Please refer to the relevant section for details.

6.2.6 Shutdown at High Voltage

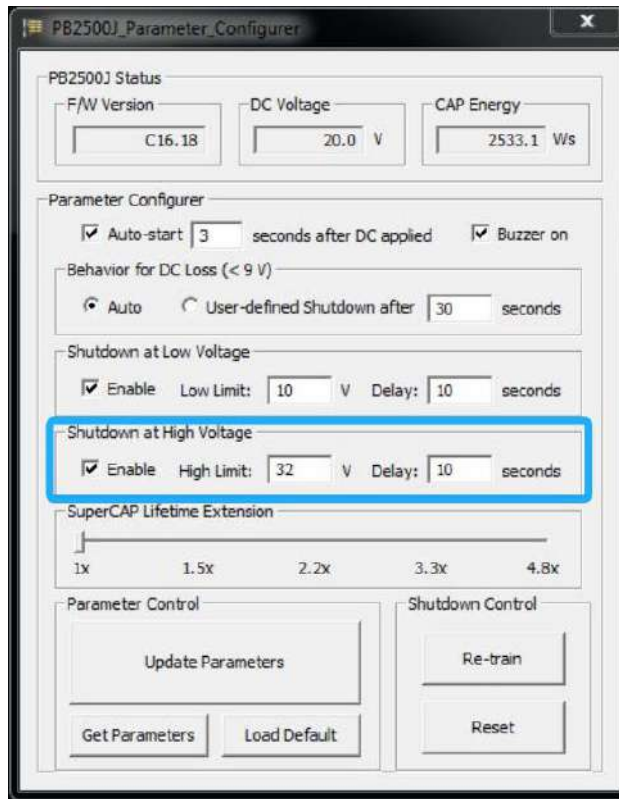

Shutdown at high voltage settings

Enable	If the “ Enable ” box is checked, the shutdown process will be determined by the High Limit: _ V and Delay: _ seconds settings.
High Limit: _ V	If the “ Enable ” box is checked, the shutdown process will be initiated by high voltage limit setting (High Limit: _ V) and the Delay: _ seconds.
Delay: _ seconds	If the “ Enable ” box is checked, the shutdown process will be initiated in _ seconds (Delay: _ seconds) when the high voltage limit setting (High Limit: _ V) is reached.



NOTE

For new parameters to take effect, you must click on “[Update Parameters](#)” and follow procedure instructions. Please refer to the relevant section for details.

6.2.7 SuperCAP Lifetime Extension

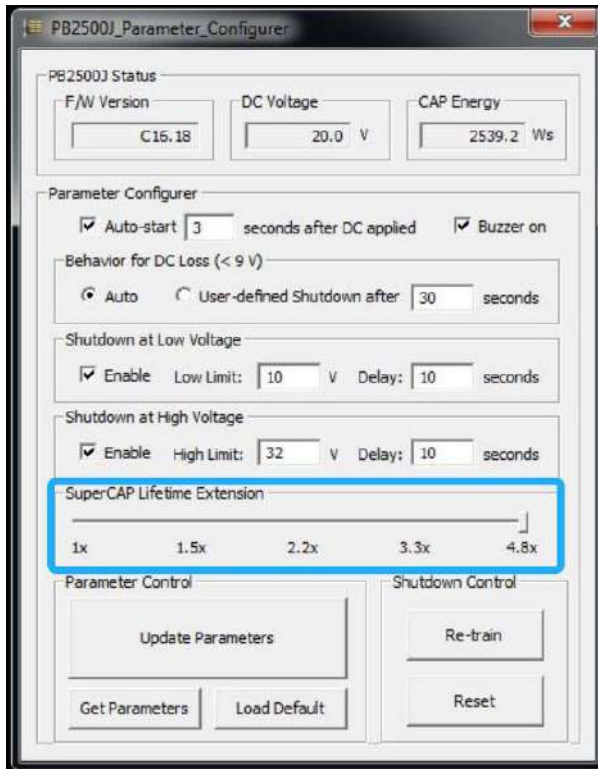

SuperCAP lifetime extension settings

The SuperCAP lifetime extension setting is an automated setting when users only need to click on the bar, drag it to the desired lifetime extension setting, click on the “Update Parameters” and follow procedure instruction for settings to take effect.



NOTE

For new parameters to take effect, you must click on “[Update Parameters](#)” and follow procedure instructions. Please refer to the relevant section for details.

6.2.8 Update Parameters

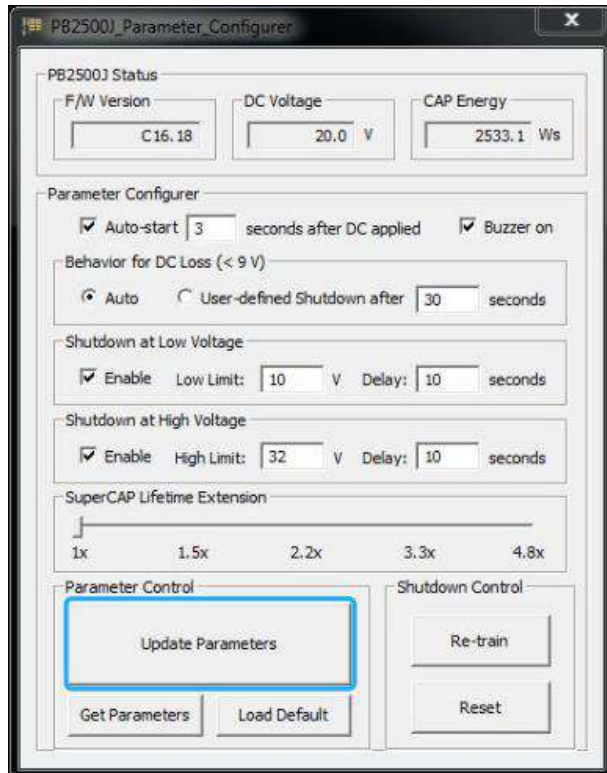

Whenever you enter/ adjust a new parameter or parameters, for the new settings to take effect, you must perform the following steps:

1. Click on the “Update Parameters” button and the following dialogue will appear.

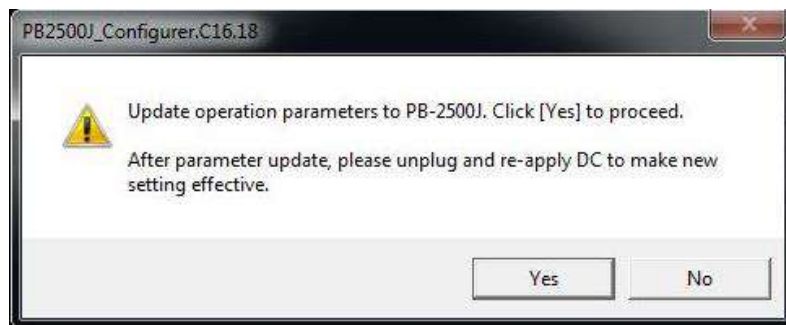

2. Click on yes, manually shutdown your system by going to “Start > Shut down”.
3. Once the system has shut down, unplug the 3-pin pluggable terminal block.
4. Wait for 5~10 seconds, plug in the 3-pin pluggable terminal block and start up your system for the new settings to take effect.

6.2.9 Get Parameters

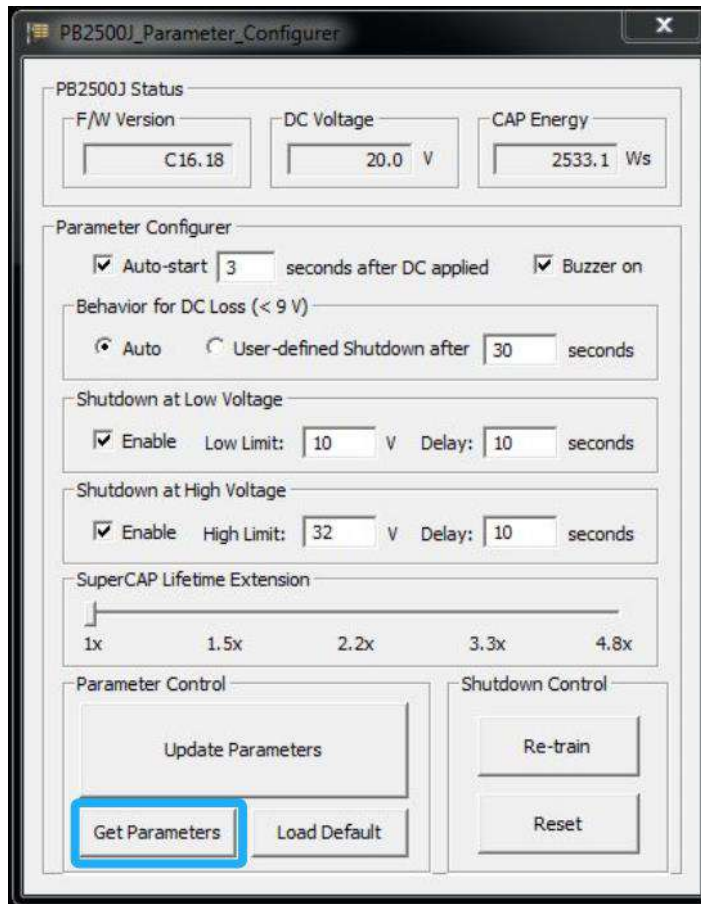

Click on “Get Parameters” to manually acquire the current PB-2500J status for F/W version, DC voltage and current stored CAP energy.

6.2.10 Load Default

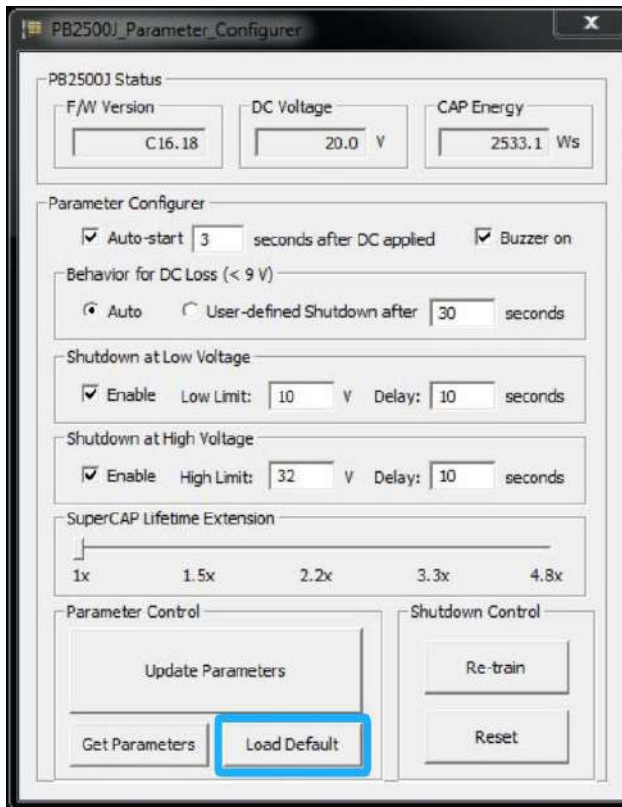

You may set PB-2500J back to the original settings by clicking on “Load Default” to reset all changes you have made previously.

6.2.11 Re-train

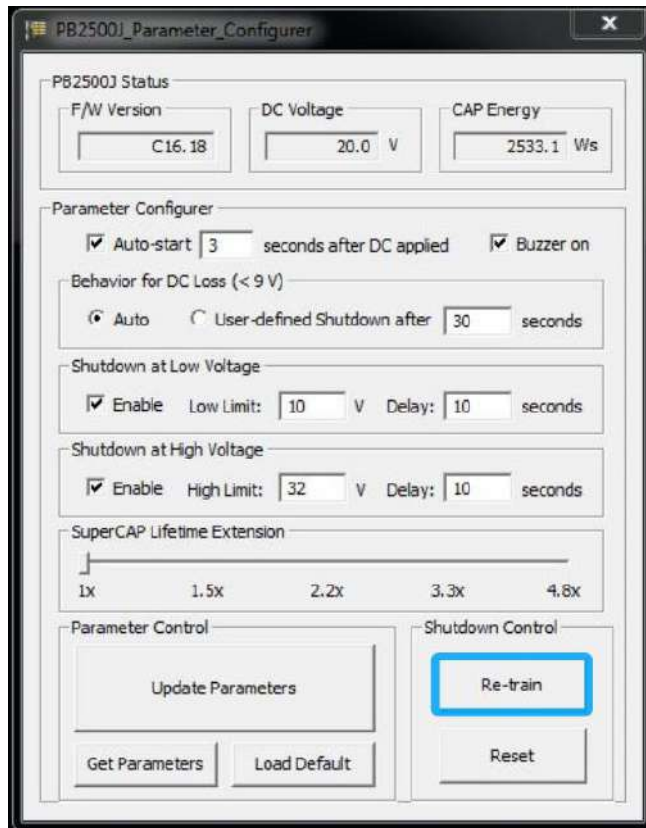

The Re-train function is to customize the PB-2500J to your system’s required shutdown time! By clicking on “Re-train”, a shutdown action will be initiated so the time required to shutdown can be memorized.

6.2.12 Reset

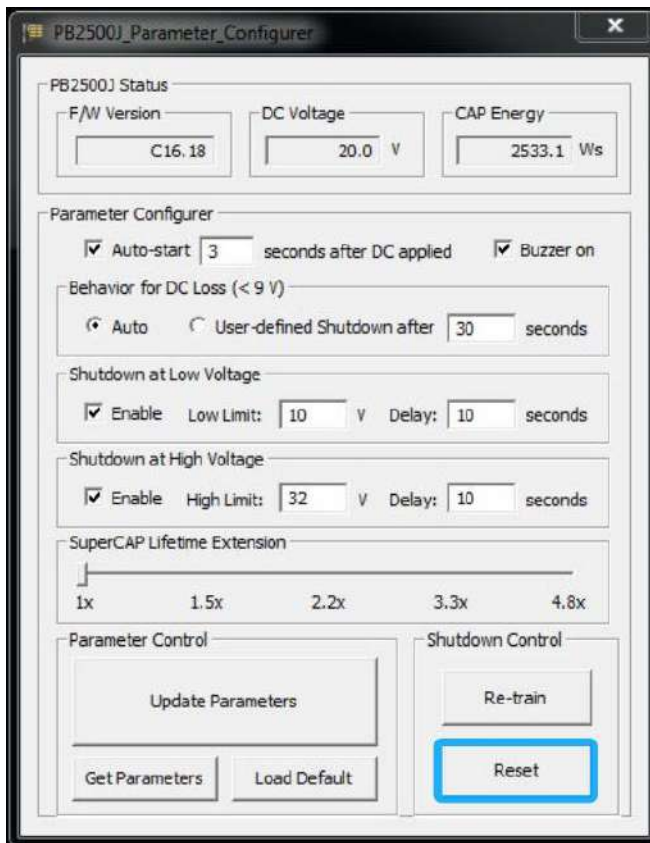

By clicking on Reset, it will erase all previous Re-train settings and hence result in immediate shutdown when a command is issued.

Appendix A: Using WDT & DIO

The watchdog timer (WDT) function to ensure reliable system operation. The WDT is a hardware mechanism to reset the system if the watchdog timer is expired. Users can start the WDT and keeping resetting the timer to make sure the system or program is running. Otherwise, the system shall be reset.

In this section, we'll illustrate how to use the function library provided by Neosys to program the WDT functions. Currently, WDT driver library supports Windows 10 x64 and WOW64 platform. For other OS support, please contact Neosys Technology for further information.

Installing WDT_DIO Library

The WDT_DIO function library is delivered in the form of a setup package named **WDT_DIO_Setup.exe**. In prior to program WDT, you should execute the setup program and install the WDT library. Please use the following WDT_DIO_Setup packages according to your operating systems and application.

- For Windows 10 64-bit OS with 64-bit application (x64 mode), please install WDT_DIO_Setup_v2.3.0 (x64).exe or later version.
- For Windows 10 64-bit OS with 32-bit application (WOW64 mode), please install WDT_DIO_Setup_v2.3.0 (wow64).exe or later version.

WDT and DIO Library Installation

To setup WDT & DIO Library, please follow instructions below.

1. Execute **WDT_DIO_Setup.2.3.0.exe** and the following dialog appears.

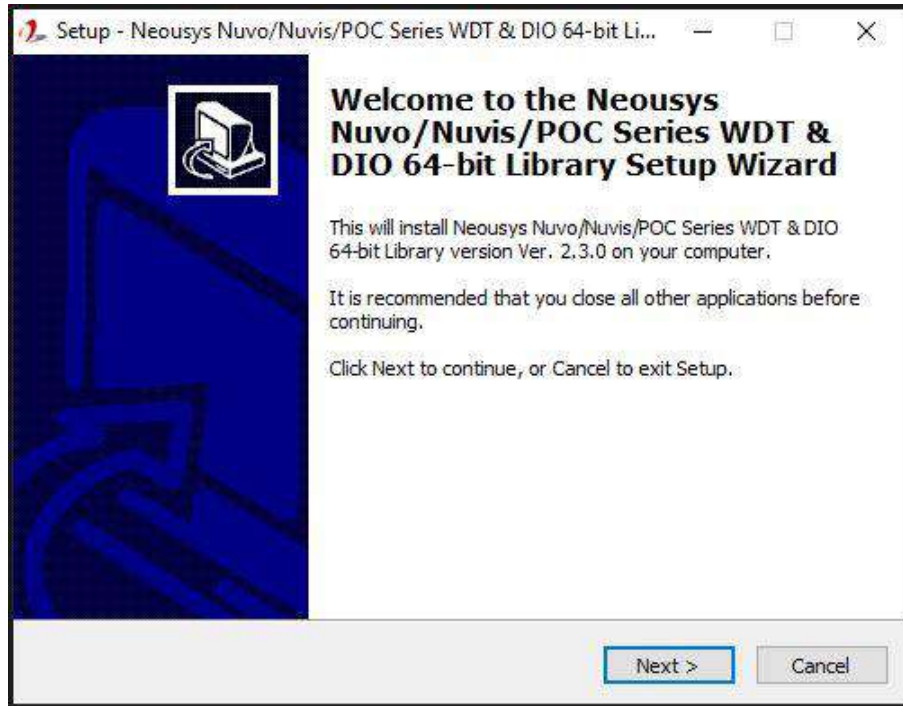

2. Click "Next >" and specify the directory of installing related files. The default directory is *C:\Neosys\WDT_DIO*.

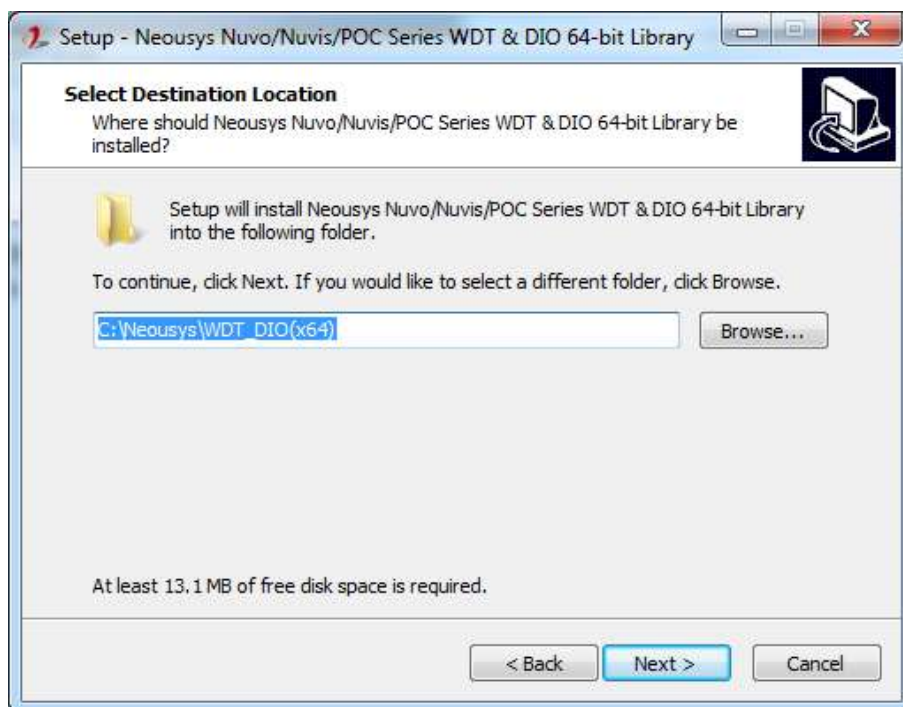

3. Once the installation has finished, a dialog will appear to prompt you to reboot the system. The WDT & DIO library will take effect after the system has rebooted.

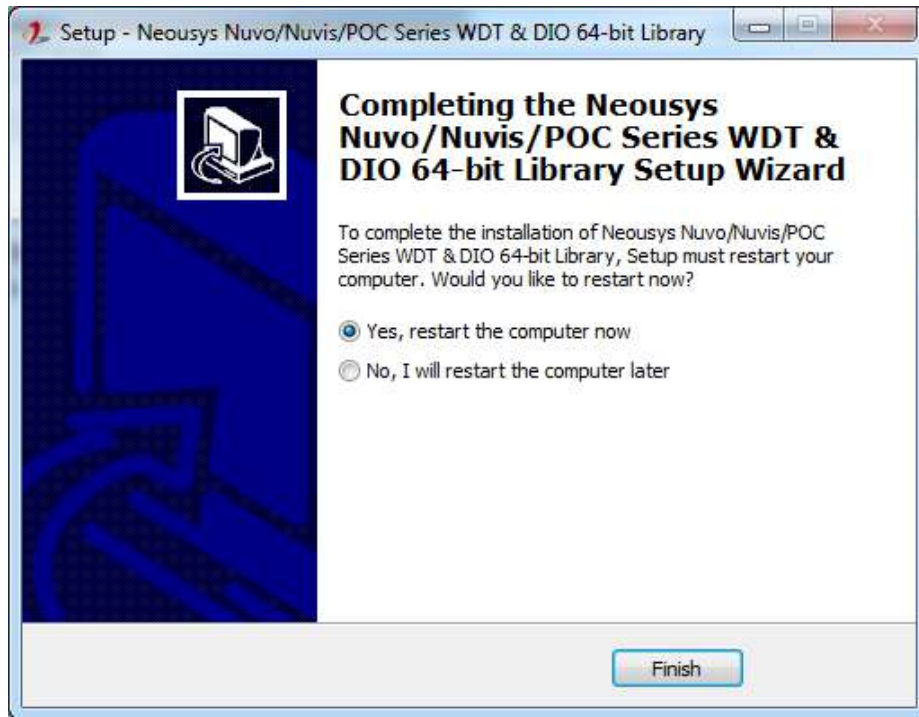

4. When programming your WDT or DIO program, the related files are located in

Header File:	\Include
Library File:	\Lib
Function	\Manual
Reference:	
Sample Code:	\Sample\WDT_Demo (Demo for Watchdog Timer) \Sample\DIO_Demo (Demo for DIO Control) \Sample\COS_Demo (Demo for change-of-state DI)* \Sample\CAN_Demo (Demo for CAN bus manipulation)* \Sample\IGN_Demo (Demo for ignition status manipulation)* \Sample\POE_Demo (Demo for PoE per-port on/off control)

WDT Function Reference

InitWDT

Syntax	BOOL InitWDT(void);
Description:	Initialize the WDT function. You should always invoke InitWDT() before set or start watchdog timer.
Parameter	None
Return Value	TRUE: Successfully initialized FALSE: Failed to initialize
Usage	BOOL bRet = InitWDT();

SetWDT

Syntax	BOOL SetWDT(WORD tick, BYTE unit);
Description	Set timeout value and unit for watchdog timer. When InitWDT() is invoked, a default timeout value of 255 seconds is assigned.
Parameter	<i>tick</i> WORD value (1 ~ 65535) to indicate timeout ticks. <i>unit</i> BYTE value (0 or 1) to indicate unit of timeout ticks. 0 : unit is minute 1: unit is second
Return Value	If value of unit is correct (0 or 1), this function returns TRUE, otherwise FALSE.
Usage	WORD tick=255; BYTE unit=1; //unit is second. BOOL bRet = SetWDT(tick, unit); //timeout value is 255 seconds

StartWDT

Syntax	BOOL StartWDT(void);
Description	Starts WDT countdown. Once started, the WDT LED indicator will begin blinking. If ResetWDT() or StopWDT is not invoked before WDT countdowns to 0, the WDT expires and the system resets.
Parameter	None
Return Value	If the timeout value is given in correct format (WDT started), this function returns TRUE, otherwise FALSE
Usage	BOOL bRet = StartWDT()

ResetWDT

Syntax	BOOL ResetWDT(void);
Description	Reset the timeout value to the value given by SetWDT().If ResetWDT() or StopWDT is not invoked before WDT countdowns to 0, the WDT expires and the system resets.
Parameter	None
Return Value	Always returns TRUE
Usage	BOOL bRet = ResetWDT()

StopWDT

Syntax	BOOL StopWDT(void);
Description	Stops the countdown of WDT. When WDT has stopped, the WDT LED indicator stops blinking.
Parameter	None
Return Value	Always returns TRUE
Usage	BOOL bRet = StopWDT()

Appendix B: PoE On/ Off Control

The system offers 802.3at PoE+ ports with a unique feature to allow users manually turn on or off the power supply of each PoE port. This can be function can be useful in power device (PD) fault-recovery or power reset.

The function APIs are encapsulated in Neousys WDT_DIO driver package. Please follow the instructions in [Appendix B Watchdog Timer & Isolated DIO](#) to install the driver package prior to programming PoE on/off control function.

GetStatusPoEPort

Syntax	BYTE GetStatusPoEPort (Byte port);
Description	Get current on/off status of designated PoE port.
Parameter	<i>port</i> BYTE value specifies the index of PoE port. Please refer to the following illustration, <i>port</i> should be a value of 1 ~ 4.
Return Value	BYTE value indicating PoE on/off status 0 if port is disabled (off) 1 if port is enabled (on)
Usage	BYTE bEnabled = GetStatusPoEPort (3); //Get on/off status of PoE Port#3

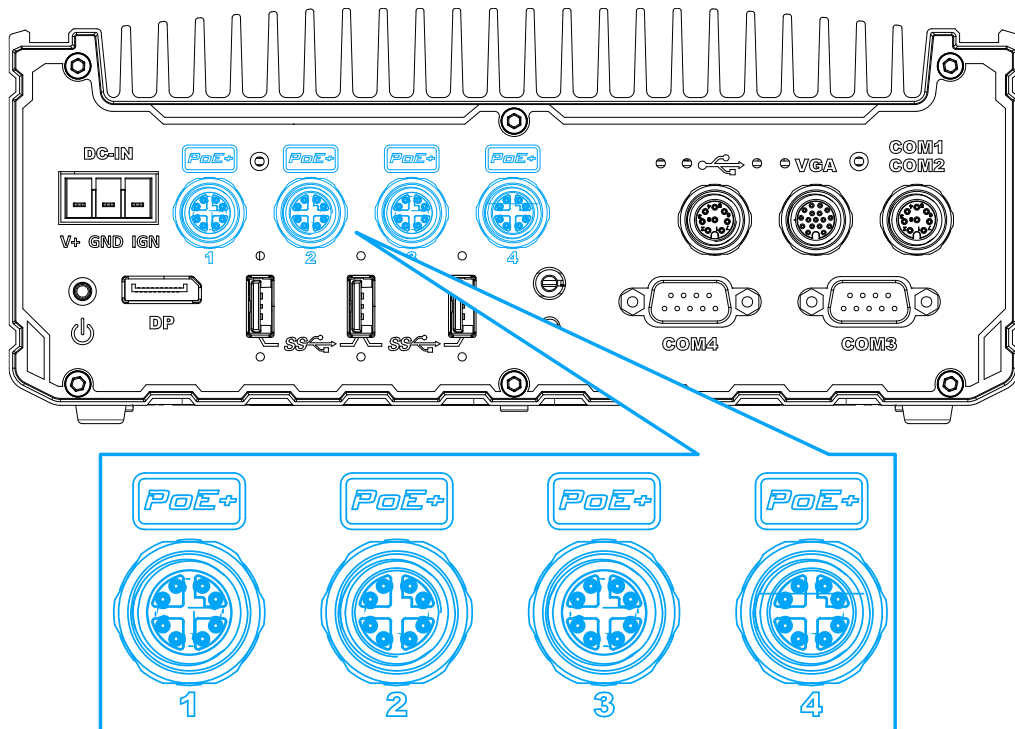

EnablePoEPort

Syntax	BOOL EnablePoEPort (BYTE port);
Description	Turn on PoE power of designated PoE port.
Parameter	<i>port</i> BYTE value specifies the index of PoE port. Please refer to the following illustration, <i>port</i> should be a value of 1 ~ 4.
Return Value	TRUE if enabled success FALSE if fail to enable.
Usage	BOOL bRet = EnablePoEPort (3); //Turn on PoE Port#3

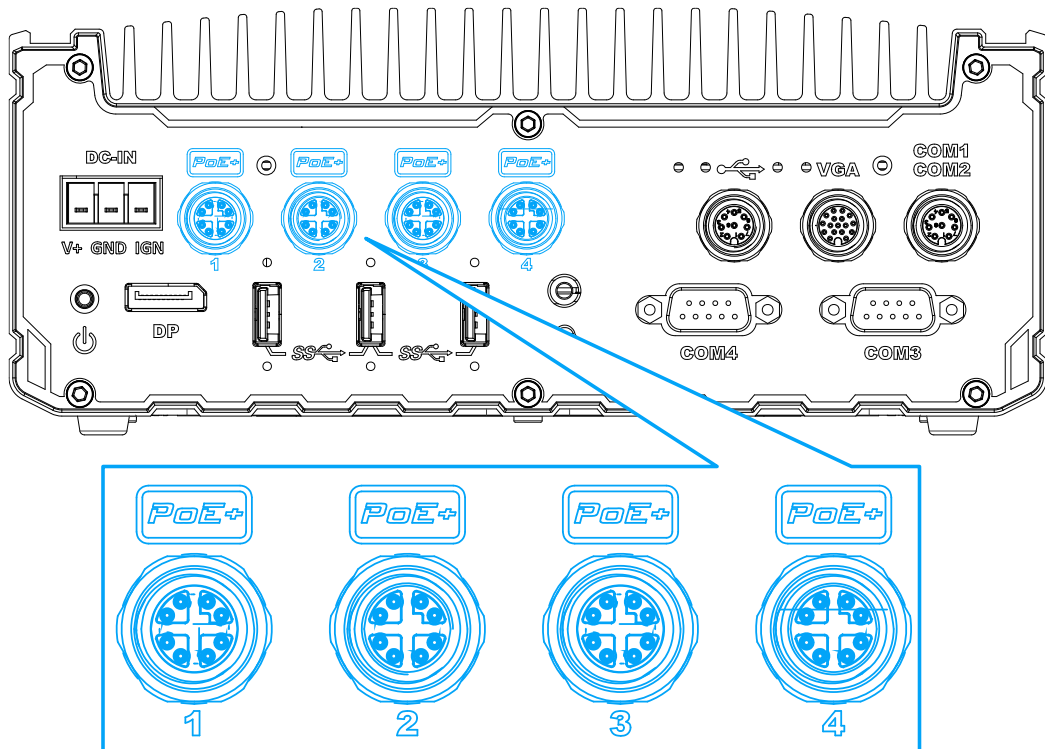

DisablePoEPort

Syntax	BOOL DisablePoEPort (BYTE port);
Description	Turn off PoE power of designated PoE port
Parameter	<i>port</i> BYTE value specifies the index of PoE port. Please refer to the following illustration, <i>port</i> should be a value of 1 ~ 4
Return Value	TRUE if disabled success FALSE if fail to disable
Usage	BOOL bRet = DisablePoEPort (3); //Turn off PoE Port#3

