



Neosys Technology Inc.

SEMIL-1700 Series

User Manual

Rev. 1.5

Table of Contents

Table of Contents	2
Legal Information	5
Contact Information	6
Declaration of Conformity	6
Copyright Notice	7
Safety Precautions	8
Battery Warning	8
Service and Maintenance	9
ESD Precautions	9
Restricted Access Location	9
About This Manual	10
1 Introduction	
1.1 SEMIL-1700 Series Overview	12
1.2 SEMIL-1704 Specifications	13
1.3 SEMIL-1708 Specifications	15
1.4 SEMIL-1714J Specifications	17
1.5 SEMIL-1718J Specifications	19
1.6 Dimension	21
1.6.1 Superior View	21
1.6.2 Front Panel View	22
1.6.3 Side View	22
1.6.4 Bottom View	23
1.7 Dimensions with Wall Mount Bracket	24
1.7.1 Front View	24
1.7.2 Bottom View	24
2 System Overview	
2.1 SEMIL-1700 Packing List	25
2.2 SEMIL-1700 Front Panel	26
2.2.1 DC-IN Connector	27
2.2.2 PoE+ Gigabit Ethernet Port	28
2.2.3 USB Port	30
2.2.4 VGA Port	31
2.2.5 Audio Port (SEMIL-17x8 Models Only)	33
2.2.6 COM1/ COM2 Port	34
2.2.7 Power Button	35
2.2.8 Optional 10Gb Ethernet	36
2.3 Internal I/Os	37
2.3.1 mini-PCIe Expansion Slot (mux with mSATA)	37
2.3.2 mini-PCIe Expansion Slot (SEMIL-17x8 Models Only)	39
2.3.3 Ignition Control Rotary Switch	41
3 Installation	
3.1 mini-PCIe Module Installation	42
3.2 Hard Drive Installation	48
3.3 Wall-mount Bracket Installation	53
3.4 Rack-mount Bracket Installation (Optional Accessory)	54
4 Ignition Power Control	
4.1 Principles of Ignition Power Control	55
4.2 Additional Features of Ignition Power Control	56
4.3 Wiring Ignition Signal	57

4.4	Configure your Windows system	58
4.5	Accessing the Rotary Switch	59
4.6	Operation Modes of Ignition Power Control	60
4.7	Reinstalling the Backplate	62
4.8	Ignition Control Setup	63
5	System Configuration	
5.1	BIOS Settings	66
5.1.1	COM Port Configuration.....	67
5.1.2	COM Port High Speed Mode	68
5.1.3	Delay for PEG Initialization	69
5.1.4	SATA Configuration.....	70
5.1.5	TPM Availability.....	72
5.1.6	Auto Wake on S5	73
5.1.7	Power On After Power Failure Option	74
5.1.8	Power & Performance (CPU SKU Power Configuration)	75
5.1.9	Wake on LAN Option	76
5.1.10	Boot Menu	77
5.1.11	Boot Type (Legacy/ UEFI).....	79
5.1.12	Boot Option for Newly Added Device	80
5.1.13	Watchdog Timer for Booting.....	81
5.1.14	Selecting Legacy/ UEFI Boot Device	82
5.2	AMT Configuration	83
5.3	RAID Volume Configuration	84
5.3.1	Legacy Mode RAID Configuration.....	84
5.3.2	UEFI Mode RAID Configuration	90
6	OS Support and Driver Installation	
6.1	Operating System Compatibility	100
6.2	Install Drivers Automatically	101
6.2.1	Install Drivers Automatically	101
6.3	Install Drivers Manually	102
6.3.1	For Windows 10 (x64).....	102
6.4	Driver Installation for Watchdog Timer Control	103
6.5	Intel® Optane™ Memory BIOS Setup and Driver Installation	104
7	CAP Energy Management Technology ~ Power Backup Parameter Configurer	
7.1	CAP Energy Management Technology	113
7.2	Power Backup Parameter Configurer	114
7.2.1	Executing PB2500J Parameter Configurer	114
7.2.2	PB-2500J Parameter Configurer.....	115
7.2.3	Auto-start	116
7.2.4	Behavior for DC Loss (<9V)	117
7.2.5	Shutdown at Low Voltage	118
7.2.6	Shutdown at High Voltage.....	119
7.2.7	SuperCAP Lifetime Extension.....	120
7.2.8	Update Parameters.....	121
7.2.9	Get Parameters.....	122
7.2.10	Load Default.....	123
7.2.11	Re-train	124
7.2.12	Reset	125
Appendix A: Using WDT & DIO		
WDT and DIO Library Installation	127	
WDT Function Reference	129	
InitWDT	129	

SetWDT	129
StartWDT	130
ResetWDT	130
StopWDT	130

Appendix B: PoE On/ Off Control

GetStatusPoEPort.....	131
EnablePoEPort.....	132
DisablePoEPort.....	133

Legal Information

All Neosys Technology Inc. products shall be subject to the latest Standard Warranty Policy

Neosys Technology Inc. may modify, update or upgrade the software, firmware or any accompanying user documentation without any prior notice. Neosys Technology Inc. will provide access to these new software, firmware or documentation releases from download sections of our website or through our service partners.

Before installing any software, applications or components provided by a third party, customer should ensure that they are compatible and interoperable with Neosys Technology Inc. product by checking in advance with Neosys Technology Inc.. Customer is solely responsible for ensuring the compatibility and interoperability of the third party's products. Customer is further solely responsible for ensuring its systems, software, and data are adequately backed up as a precaution against possible failures, alternation, or loss.

For questions in regards to hardware/ software compatibility, customers should contact Neosys Technology Inc. sales representative or technical support.

To the extent permitted by applicable laws, Neosys Technology Inc. shall NOT be responsible for any interoperability or compatibility issues that may arise when (1) products, software, or options not certified and supported; (2) configurations not certified and supported are used; (3) parts intended for one system is installed in another system of different make or model.

Contact Information

Headquarters
(Taipei, Taiwan)

Neosys Technology Inc.
15F, No.868-3, Zhongzheng Rd., Zhonghe Dist., New Taipei City, 23586, Taiwan
Tel: +886-2-2223-6182 Fax: +886-2-2223-6183 [Email](#), [Website](#)

Americas
(Illinois, USA)

Neosys Technology America Inc.
3384 Commercial Avenue, Northbrook, IL 60062, USA
Tel: +1-847-656-3298 [Email](#), [Website](#)

China

Neosys Technology (China) Ltd.
Room 612, Building 32, Guiping Road 680, Shanghai
Tel: +86-2161155366 [Email](#), [Website](#)

Declaration of Conformity

FCC

This equipment has been tested and found to comply with the limits for a Class A digital device, pursuant to part 15 of the FCC Rules. These limits are designed to provide reasonable protection against harmful interference when the equipment is operated in a commercial environment. This equipment generates, uses, and can radiate radio frequency energy and, if not installed and used in accordance with the instruction manual, may cause harmful interference to radio communications. Operation of this equipment in a residential area is likely to cause harmful interference in which case the user will be required to correct the interference at own expense.

CE

The product(s) described in this manual complies with all applicable European Union (CE) directives if it has a CE marking. For computer systems to remain CE compliant, only CE-compliant parts may be used. Maintaining CE compliance also requires proper cable and cabling techniques.

Copyright Notice

All rights reserved. This publication may not be reproduced, transmitted, transcribed, stored in a retrieval system, or translated into any language or computer language, in any form or by any means, electronic, mechanical, magnetic, optical, chemical, manual or otherwise, without the prior written consent of Neosys Technology, Inc.

Disclaimer

This manual is intended to be used as an informative guide only and is subject to change without prior notice. It does not represent commitment from Neosys Technology Inc. Neosys Technology Inc. shall not be liable for any direct, indirect, special, incidental, or consequential damages arising from the use of the product or documentation, nor for any infringement on third party rights.

Patents and Trademarks

Neosys, the Neosys logo, Expansion Cassette, MezIO™ are registered patents and trademarks of Neosys Technology, Inc.

Windows is a registered trademark of Microsoft Corporation.

Intel®, Core™ is a registered trademark of Intel Corporation

NVIDIA®, GeForce® is a registered trademark of NVIDIA Corporation

Texas Instruments (TI) and Sitara are registered trademarks of Texas Instruments Incorporated.

All other names, brands, products or services are trademarks or registered trademarks of their respective owners.

Safety Precautions

- Read these instructions carefully before you install, operate, or transport the system.
- Install the system or DIN rail associated with, at a sturdy location
- Install the power socket outlet near the system where it is easily accessible
- Secure each system module(s) using its retaining screws
- Place power cords and other connection cables away from foot traffic. Do not place items over power cords and make sure they do not rest against data cables
- Shutdown, disconnect all cables from the system and ground yourself before touching internal modules
- Ensure that the correct power range is being used before powering the device
- Should a module fail, arrange for a replacement as soon as possible to minimize down-time
- If the system is not going to be used for a long time, disconnect it from mains (power socket) to avoid transient over-voltage

Battery Warning

- Batteries are at risk of exploding if incorrectly installed
- Do not attempt to recharge, force open, or heat the battery
- Replace the battery only with the same or equivalent type recommended by the manufacturer

Caution!



Service and Maintenance

- ONLY qualified personnel should service the system
- Shutdown the system, disconnect the power cord and all other connections before servicing the system
- When replacing/ installing additional components (expansion card, memory module, etc.), insert them as gently as possible while assuring connectors are properly engaged

ESD Precautions

- Handle add-on module, motherboard by their retention screws or the module's frame/ heat sink. Avoid touching the PCB circuit board or add-on module connector pins
- Use a grounded wrist strap and an anti-static work pad to discharge static electricity when installing or maintaining the system
- Avoid dust, debris, carpets, plastic, vinyl and Styrofoam in your work area.
- Do not remove any module or component from its anti-static bag before installation

Restricted Access Location

The controller is intended for installation only in the certain environment where both these condition apply:

- Access can only be gained by SERVICE PERSONS or by USERS who have been instructed about the reasons for the restrictions applied to the location and about any precautions that shall be taken
- Access is through the use of a TOOL or lock and key, or other means of security, and is controlled by the authority responsible for the location

About This Manual

This manual introduces Neosys Technology SEMIL-1700 series, a 2U half-rack IP67 waterproof extreme-rugged fanless computer. It features workstation-grade Intel® chipset and offers excellent passive thermal performance with M12 connectors for robust and cost-effectiveness.

Applicable systems

Model No.	Description
SEMIL-1704	Half-rack IP67 waterproof computer including Intel® Xeon® E or 9th / 8th-Gen Core™ processor with 4x M12 PoE+ ports
SEMIL-1704-10G	Half-rack IP67 waterproof computer including Intel® Xeon® E or 9th / 8th-Gen Core™ processor with 4x M12 PoE+ ports and 10GbE port
SEMIL-1708	Half-rack IP67 waterproof computer including Intel® Xeon® E or 9th / 8th-Gen Core™ processor with 8x M12 PoE+ ports
SEMIL-1708-10G	Half-rack IP67 waterproof computer including Intel® Xeon® E or 9th / 8th-Gen Core™ processor with 8x M12 PoE+ ports and 10GbE port
SEMIL-1714J	Half-rack IP67 waterproof computer including Intel® Xeon® E or 9th / 8th-Gen Core™ processor with 4x M12 PoE+ ports and 2500 watt-second SuperCAP UPS
SEMIL-1714J-10G	Half-rack IP67 waterproof computer including Intel® Xeon® E or 9th / 8th-Gen Core™ processor with 4x M12 PoE+ ports, 2500 watt-second SuperCAP UPS and 10GbE port
SEMIL-1718J	Half-rack IP67 waterproof computer including Intel® Xeon® E or 9th / 8th-Gen Core™ processor with 8x M12 PoE+ ports and 2500 watt-second SuperCAP UPS
SEMIL-1718J-10G	Half-rack IP67 waterproof computer including Intel® Xeon® E or 9th / 8th-Gen Core™ processor with 8x M12 PoE+ ports and 2500 watt-second SuperCAP UPS and 10GbE port



NOTE

Installing after-sales internal modules on your own may affect its waterproof capabilities and is not recommended. If you must install internal modules after purchase, please consult your sales representative as you may need to return the system to Neosys Technology or an authorized SEMIL distributor for processing.

Revision History

Version	Date	Description
1.0	May. 2023	Initial release
1.1	May. 2023	Updated mini-PCIe specifications
1.2	Jun. 2023	Updated the unit for screw torque range, for securing the enclosure panel
1.3	Nov. 2023	Updated ignition power control, supercapacitor configuration, and optional 10G Ethernet descriptions
1.4	Jan. 2024	Updated "PB2500J Parameter Configurer" connection setting to COM5 port
1.5	Sep. 2024	Updated EMC certifications

1 Introduction

SEMIL-1700 series is a 2U half-rack extreme-rugged IP67 waterproof capable computer that features an Intel® work-station grade chipset to power a Xeon or 9th/ 8th-Gen Core™ processor. Coupled with M12 connectors, the system is design to meet the ever changing harsh environmental conditions that can no longer be met by traditional industrial computers.

1.1 SEMIL-1700 Series Overview

SEMIL-1700 series is one of the world's first IP67-rated, waterproof and dustproof inference server. It takes industrial computing to a new level of robustness for rugged edge AI solutions. Coupled with Intel® Xeon® E or 9th/ 8th-Gen Core™ CPU, the system is capable of delivering excellent CPU performances for advanced edge AI applications in extreme environmental settings. With Neosys patented architecture, it guarantees -40 °C to 70°C fanless operation in a rack or wall-mountable 2U half-rack 19" enclosure.



Featuring a sophisticated thermal design, it effectively dissipates the heat in high-temperature environments. Its enclosure is a corrosion-proof, stainless steel/ aluminum chassis with molded O-rings plus patented fusion mechanism design to offer extraordinary durability and watertight construction. SEMIL-1700 series offers a variety of I/O connectivity, including 802.3at Gigabit PoE+, VGA, USB, COM ports and optional 10G Ethernet, all using M12 connectors for water-proof and extreme-rugged connectivity. Additionally, it features M.2 for NVMe SSD, 2.5" SATA storage accommodation, 8-48V wide-range DC input with ignition power control and is in compliance with MIL-STD-810G and EN 50155.

1.2 SEMIL-1704 Specifications

System Platform	
Processor	Supporting Intel® Xeon® E and 9 th / 8 th -Gen CPU (LGA1151 socket) - Xeon E 2176G (6C/12T) / 2278GE (8C/16T) / 2278GEL (8C/16T) - Intel® Core™ i7-9700TE/ i7-9700E/ i7-8700T/ i7-8700 - Intel® Core™ i5-9500TE/ i5-9500E/ i5-8500T/ i5-8500 - Intel® Core™ i3-9100TE/ i3-9100E/ i3-8100T/ i3-8100
Chipset	Intel® C246 platform
Graphics	Integrated Intel® HD Graphics 630
Memory	2x 260-pin SO-DIMM sockets, up to 64GB DDR4 2666/ 2400MHz SDRAM
AMT	Supports AMT 12.0
TPM	Supports TPM 2.0
I/O Interface	
PoE+	1x IEEE 802.3at (25.5W) Gigabit PoE+ ports by Intel® I219 (M12 X-coded) 3x IEEE 802.3at (25.5W) Gigabit PoE+ ports by Intel® I210 (M12 X-coded)
10 GbE Port (Build Option)	Optional: 1x 10 GbE port by Intel® X550AT controller (M12 X-coded)
Native Video Port	1x VGA (M12 A-coded), supporting 1920 x 1200 resolution
Serial Port	2x 3-wire RS-232 ports COM1 & COM2 (M12 A-coded)
USB	2x USB 2.0 (M12 A-coded) 1x USB 2.0 (internal)
Audio	NA
Storage Interface	
SATA HDD	2x internal SATA ports for 2.5" HDD/ SSD installation, supporting RAID 0/ 1
mSATA	2x full-size mSATA ports (mux with mini-PCIe)
M.2	1x M.2 2280 M key socket (PCIe Gen3 x4) for NVMe SSD or Intel® Optane™ memory installation
Expansion Bus	
Mini PCI-E	2x full-size mini PCI Express sockets (mux with mSATA)
Power Supply	
DC Input	8 to 48V DC input (M12 S-coded)
Ignition Control	Built-in ignition power control (IGN/ GND signal via M12 serial port connector)

Max. Power Consumption	Intel® Xeon® E-2278GE (max.TDP) - 108.96W(24V) - 114.24W(48V) Intel® Xeon® E-2278GE (35 W) - 72.96W(24V) - 76.32W(48V)
Mechanical	
Dimension	220mm (W) x 310mm (D) x 90.5mm (H)
Weight	5.8 kg
Mounting Method	Rack-mount and wall-mount
Environmental	
Operating Temperature	With 35W CPU -40°C ~ 70°C **/ *** With >= 65W CPU -40°C ~ 70°C **/ *** (configured as 35W TDP mode) -40°C ~ 50°C **/ *** (configured as 65W TDP mode)
Storage Temperature	-40°C ~85°C
Humidity	10%~90%, non-condensing
Vibration	Operating, MIL-STD-810G, Method 514.7, Category 4
Shock	Operating, MIL-STD-810G, Method 516.7, Procedure I
EMC	EN 50121 (EN 50155 EMC) CE/FCC Class A, according to EN 55032 & EN 55035

** For Xeon E 2176G/ 2278GE, i7-9700E, and i7-8700 running at 65W mode, the highest operating temperature shall be limited to 50°C and thermal throttling may occur when sustained full-loading applied. Users can configure the CPU TDP in BIOS to obtain higher operating temperature.

*** For sub-zero operating temperature, a wide temperature HDD or Solid State Disk (SSD) is required.

1.3 SEMIL-1708 Specifications

System Platform	
Processor	Supporting Intel® Xeon® E and 9 th / 8 th -Gen CPU (LGA1151 socket) - Xeon E 2176G (6C/12T) / 2278GE (8C/16T) / 2278GEL (8C/16T) - Intel® Core™ i7-9700TE/ i7-9700E/ i7-8700T/ i7-8700 - Intel® Core™ i5-9500TE/ i5-9500E/ i5-8500T/ i5-8500 - Intel® Core™ i3-9100TE/ i3-9100E/ i3-8100T/ i3-8100
Chipset	Intel® C246 platform
Graphics	Integrated Intel® HD Graphics 630
Memory	2x 260-pin SO-DIMM sockets, up to 64GB DDR4 2666/ 2400MHz SDRAM
AMT	Supports AMT 12.0
TPM	Supports TPM 2.0
I/O Interface	
PoE+	1x IEEE 802.3at (25.5W) Gigabit PoE+ ports by Intel® I219 (M12 X-coded) 7x IEEE 802.3at (25.5W) Gigabit PoE+ ports by Intel® I210 (M12 X-coded)
10 GbE Port (Build Option)	Optional: 1x 10 GbE port by Intel® X550AT controller (M12 X-coded)
Native Video Port	1x VGA (M12 A-coded), supporting 1920 x 1200 resolution
Serial Port	2x 3-wire RS-232 ports COM1 & COM2 (M12 A-coded)
USB	4x USB 2.0 (M12 A-coded) 1x USB 2.0 (internal)
Audio	1x mic-in and speaker-out (M12 A-coded)
Storage Interface	
SATA HDD	2x internal SATA ports for 2.5" HDD/ SSD installation, supporting RAID 0/ 1
mSATA	2x full-size mSATA ports (mux with mini-PCIe)
M.2	1x M.2 2280 M key socket (PCIe Gen3 x4) for NVMe SSD or Intel® Optane™ memory installation
Expansion Bus	
Mini PCI-E	2x full-size mini PCI Express sockets (mux with mSATA) 2x full-size mini PCI Express sockets
Power Supply	
DC Input	8 to 48V DC input (M12 S-coded)
Ignition	Built-in ignition power control (IGN/ GND signal via M12 serial port connector)

Control	
Max. Power Consumption	Intel® Xeon® E-2278GE (max.TDP) - 108.96W(24V) - 114.24W(48V) Intel® Xeon® E-2278GE (35 W) - 72.96W(24V) - 76.32W(48V)
Mechanical	
Dimension	220mm (W) x 310mm (D) x 90.5mm (H) (excluding rack-mount bracket)
Weight	5.9 kg
Mounting Method	Rack-mount and wall-mount
Environmental	
Operating Temperature	With 35W CPU -40°C ~ 70°C **/ *** With >= 65W CPU -40°C ~ 70°C **/ *** (configured as 35W TDP mode) -40°C ~ 50°C **/ *** (configured as 65W TDP mode)
Storage Temperature	-40°C ~85°C
Humidity	10%~90%, non-condensing
Vibration	Operating, MIL-STD-810G, Method 514.7, Category 4
Shock	Operating, MIL-STD-810G, Method 516.7, Procedure I
EMC	EN 50121 (EN 50155 EMC) CE/FCC Class A, according to EN 55032 & EN 55035

** For Xeon E 2176G/ 2278GE, i7-9700E, and i7-8700 running at 65W mode, the highest operating temperature shall be limited to 50°C and thermal throttling may occur when sustained full-loading applied. Users can configure the CPU TDP in BIOS to obtain higher operating temperature.

*** For sub-zero operating temperature, a wide temperature HDD or Solid State Disk (SSD) is required.

1.4 SEMIL-1714J Specifications

System Platform	
Processor	Supporting Intel® Xeon® E and 9 th / 8 th -Gen CPU (LGA1151 socket) - Xeon E 2176G (6C/12T) / 2278GE (8C/16T) / 2278GEL (8C/16T) - Intel® Core™ i7-9700TE/ i7-9700E/ i7-8700T/ i7-8700 - Intel® Core™ i5-9500TE/ i5-9500E/ i5-8500T/ i5-8500 - Intel® Core™ i3-9100TE/ i3-9100E/ i3-8100T/ i3-8100
Chipset	Intel® C246 platform
Graphics	Integrated Intel® HD Graphics 630
Memory	2x 260-pin SO-DIMM sockets, up to 64GB DDR4 2666/ 2400MHz SDRAM
AMT	Supports AMT 12.0
TPM	Supports TPM 2.0
I/O Interface	
PoE+	1x IEEE 802.3at (25.5W) Gigabit PoE+ ports by Intel® I219 (M12 X-coded) 3x IEEE 802.3at (25.5W) Gigabit PoE+ ports by Intel® I210 (M12 X-coded)
10 GbE Port (Build Option)	Optional: 1x 10 GbE port by Intel® X550AT controller (M12 X-coded)
Native Video Port	1x VGA (M12 A-coded), supporting 1920 x 1200 resolution
Serial Port	2x 3-wire RS-232 ports COM1 & COM2 (M12 A-coded)
USB	2x USB 2.0 (M12 A-coded) 1x USB 2.0 (internal)
Audio	NA
Storage Interface	
SATA HDD	2x internal SATA ports for 2.5" HDD/ SSD installation, supporting RAID 0/ 1
mSATA	2x full-size mSATA ports (mux with mini-PCIe)
M.2	1x M.2 2280 M key socket (PCIe Gen3 x4) for NVMe SSD or Intel® Optane™ memory installation
Expansion Bus	
Mini PCI-E	2x full-size mini PCI Express sockets (mux with mSATA)
Power Supply	
DC Input	8 to 48V DC input (M12 S-coded)
Ignition Control	Built-in ignition power control (IGN/ GND signal via M12 serial port connector)

Power Backup	
Capacity	2500 watt-second
Max. Power Consumption	Intel® Xeon® E-2278GE (max.TDP) - 108.96W(24V) - 114.24W(48V) Intel® Xeon® E-2278GE (35 W) - 72.96W(24V) - 76.32W(48V)
Mechanical	
Dimension	440mm (W) x 310mm (D) x 90.5mm (H) (excluding rack-mount bracket)
Weight	6 kg
Mounting Method	Rack-mount and wall-mount
Environmental	
Operating Temperature	With 35W CPU -40°C ~ 70°C **/ *** With >= 65W CPU -40°C ~ 70°C **/ *** (configured as 35W TDP mode) -40°C ~ 50°C **/ *** (configured as 65W TDP mode)
Storage Temperature	-40°C ~85°C
Humidity	10%~90%, non-condensing
Vibration	Operating, MIL-STD-810G, Method 514.7, Category 4
Shock	Operating, MIL-STD-810G, Method 516.7, Procedure I
EMC	EN 50121 (EN 50155 EMC) CE/FCC Class A, according to EN 55032 & EN 55035

** For Xeon E 2176G/ 2278GE, i7-9700E, and i7-8700 running at 65W mode, the highest operating temperature shall be limited to 50°C and thermal throttling may occur when sustained full-loading applied. Users can configure the CPU TDP in BIOS to obtain higher operating temperature.

*** For sub-zero operating temperature, a wide temperature HDD or Solid State Disk (SSD) is required.

1.5 SEMIL-1718J Specifications

System Platform	
Processor	Supporting Intel® Xeon® E and 9 th / 8 th -Gen CPU (LGA1151 socket) - Xeon E 2176G (6C/12T) / 2278GE (8C/16T) / 2278GEL (8C/16T) - Intel® Core™ i7-9700TE/ i7-9700E/ i7-8700T/ i7-8700 - Intel® Core™ i5-9500TE/ i5-9500E/ i5-8500T/ i5-8500 - Intel® Core™ i3-9100TE/ i3-9100E/ i3-8100T/ i3-8100
Chipset	Intel® C246 platform
Graphics	Integrated Intel® HD Graphics 630
Memory	2x 260-pin SO-DIMM sockets, up to 64GB DDR4 2666/ 2400MHz SDRAM
AMT	Supports AMT 12.0
TPM	Supports TPM 2.0
I/O Interface	
PoE+	1x IEEE 802.3at (25.5W) Gigabit PoE+ ports by Intel® I219 (M12 X-coded) 7x IEEE 802.3at (25.5W) Gigabit PoE+ ports by Intel® I210 (M12 X-coded)
10 GbE Port (Build Option)	Optional: 1x 10 GbE port by Intel® X550AT controller (M12 X-coded)
Native Video Port	1x VGA (M12 A-coded), supporting 1920 x 1200 resolution
Serial Port	2x 3-wire RS-232 ports COM1 & COM2 (M12 A-coded)
USB	2x USB 2.0 (M12 A-coded) 1x USB 2.0 (internal)
Audio	1x mic-in and speaker-out (M12 A-coded)
Storage Interface	
SATA HDD	2x internal SATA ports for 2.5" HDD/ SSD installation, supporting RAID 0/ 1
mSATA	2x full-size mSATA ports (mux with mini-PCIe)
M.2	1x M.2 2280 M key socket (PCIe Gen3 x4) for NVMe SSD or Intel® Optane™ memory installation
Expansion Bus	
Mini PCI-E	2x full-size mini PCI Express sockets (mux with mSATA) 2x full-size mini PCI Express sockets
Power Supply	
DC Input	8 to 48V DC input (M12 S-coded)
Ignition	Built-in ignition power control (IGN/ GND signal via M12 serial port connector)

Control	
Power Backup	
Capacity	2500 watt-second
Max. Power Consumption	Intel® Xeon® E-2278GE (max.TDP) - 108.96W(24V) - 114.24W(48V) Intel® Xeon® E-2278GE (35 W) - 72.96W(24V) - 76.32W(48V)
Mechanical	
Dimension	220mm (W) x 310mm (D) x 90.5mm (H) (excluding rack-mount bracket)
Weight	6.2 kg
Mounting Method	Rack-mount and wall-mount
Environmental	
Operating Temperature	With 35W CPU -40°C ~ 70°C **/ *** With >= 65W CPU -40°C ~ 70°C **/ *** (configured as 35W TDP mode) -40°C ~ 50°C **/ *** (configured as 65W TDP mode)
Storage Temperature	-40°C ~85°C
Humidity	10%~90%, non-condensing
Vibration	Operating, MIL-STD-810G, Method 514.7, Category 4
Shock	Operating, MIL-STD-810G, Method 516.7, Procedure I
EMC	EN 50121 (EN 50155 EMC) CE/FCC Class A, according to EN 55032 & EN 55035

** For Xeon E 2176G/ 2278GE, i7-9700E, and i7-8700 running at 65W mode, the highest operating temperature shall be limited to 50°C and thermal throttling may occur when sustained full-loading applied. Users can configure the CPU TDP in BIOS to obtain higher operating temperature.

*** For sub-zero operating temperature, a wide temperature HDD or Solid State Disk (SSD) is required.

1.6 Dimension

 NOTE

All measurements are in millimeters (mm).

1.6.1 Superior View

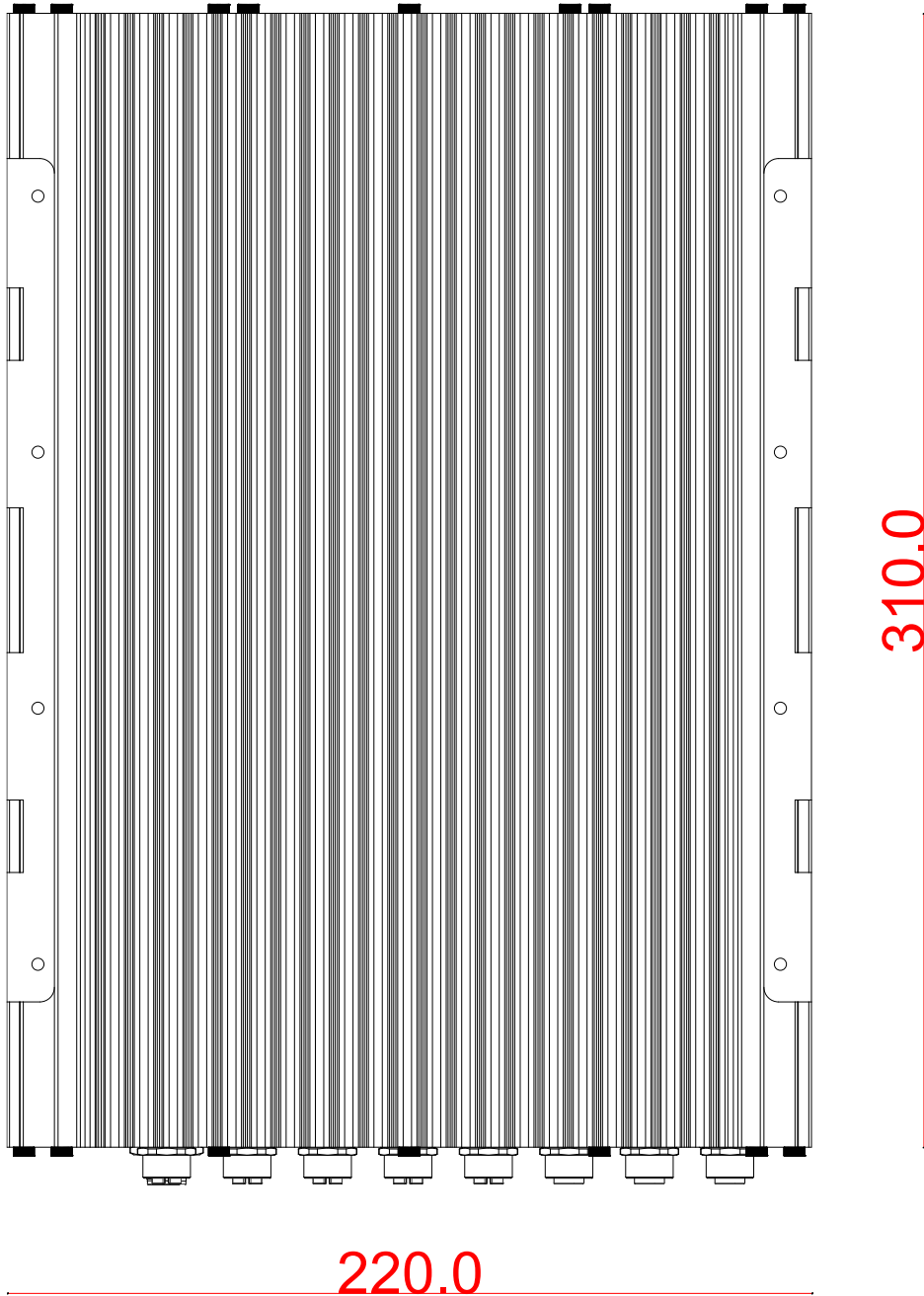

1.6.2 Front Panel View

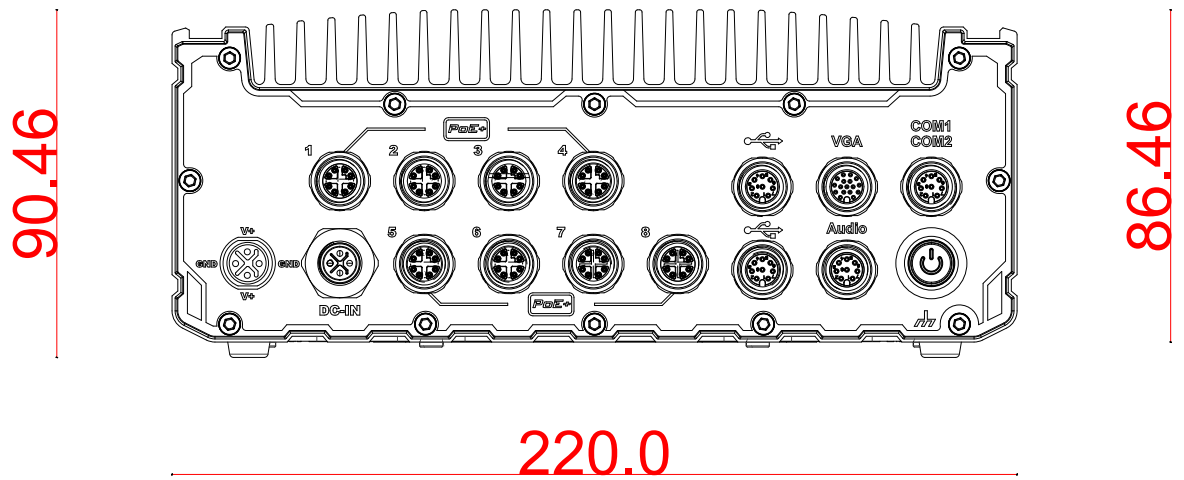

1.6.3 Side View

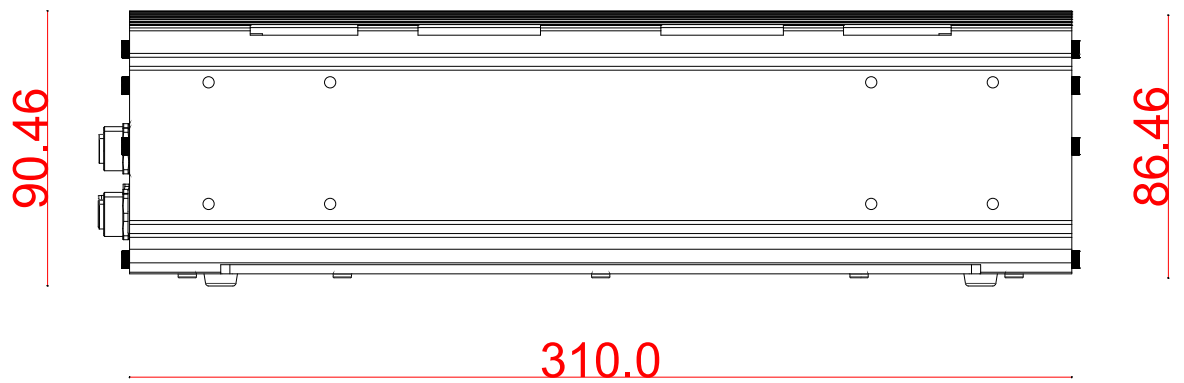

1.6.4 Bottom View

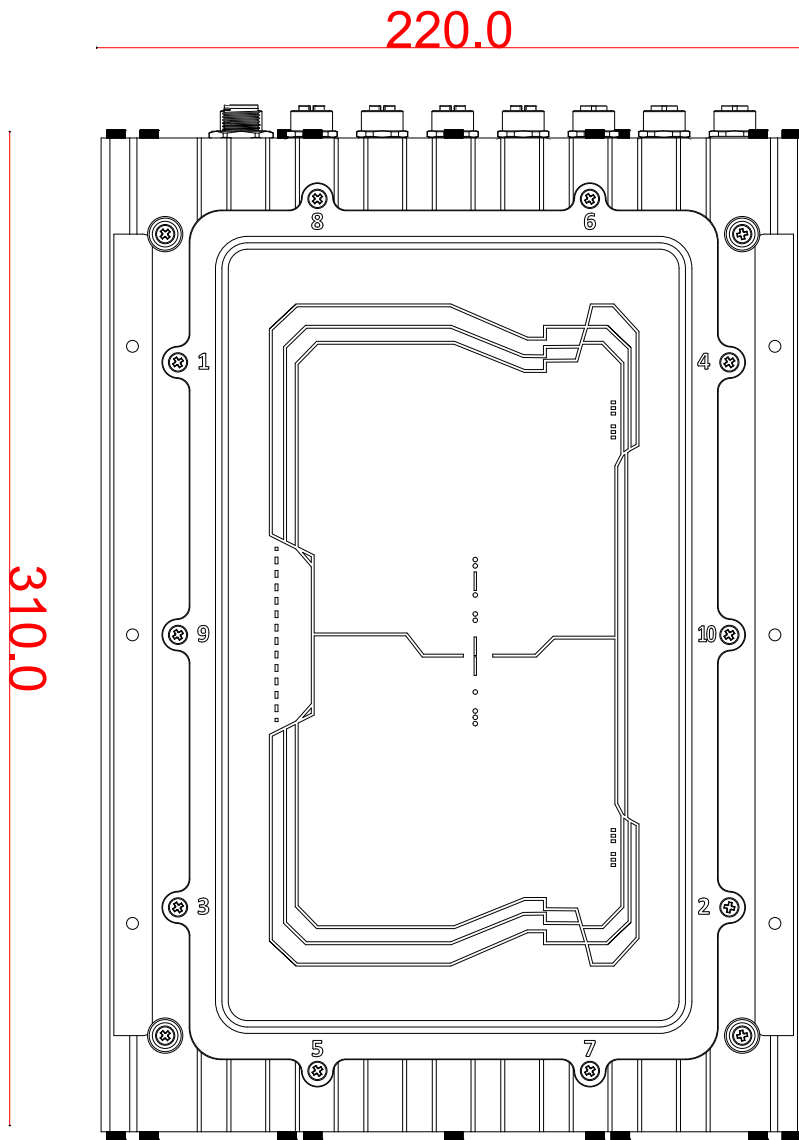

1.7 Dimensions with Wall Mount Bracket

 **NOTE**

All measurements are in millimeters (mm).

1.7.1 Front View

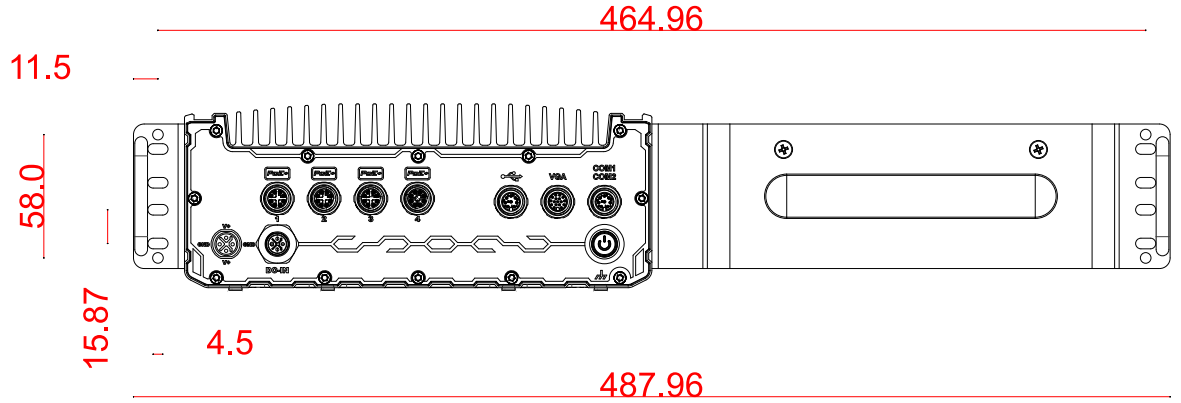

1.7.2 Bottom View

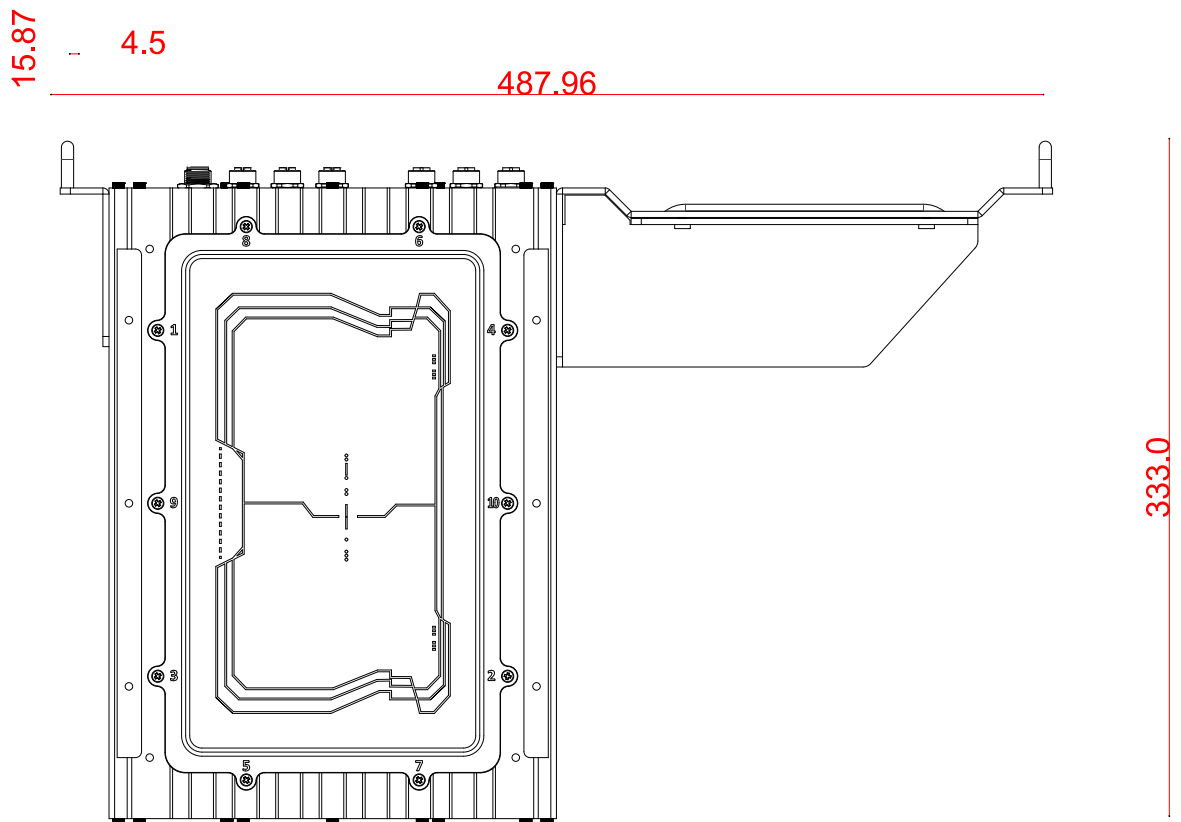

2 System Overview

Upon receiving and unpacking your system, please check immediately if the package contains all the items listed in the following table. If any item(s) are missing or damaged, please contact your local dealer or Neousys Technology.

2.1 SEMIL-1700 Packing List

System Pack	SEMIL-1700	Qty
1	SEMIL-1700 system (If you ordered CPU, RAM, HDD etc., please verify these items)	1
2	Accessory box, which contains CPU bracket Neousys Drivers & Utilities DVD Wall-mounting bracket	1 1 2

2.2 SEMIL-1700 Front Panel

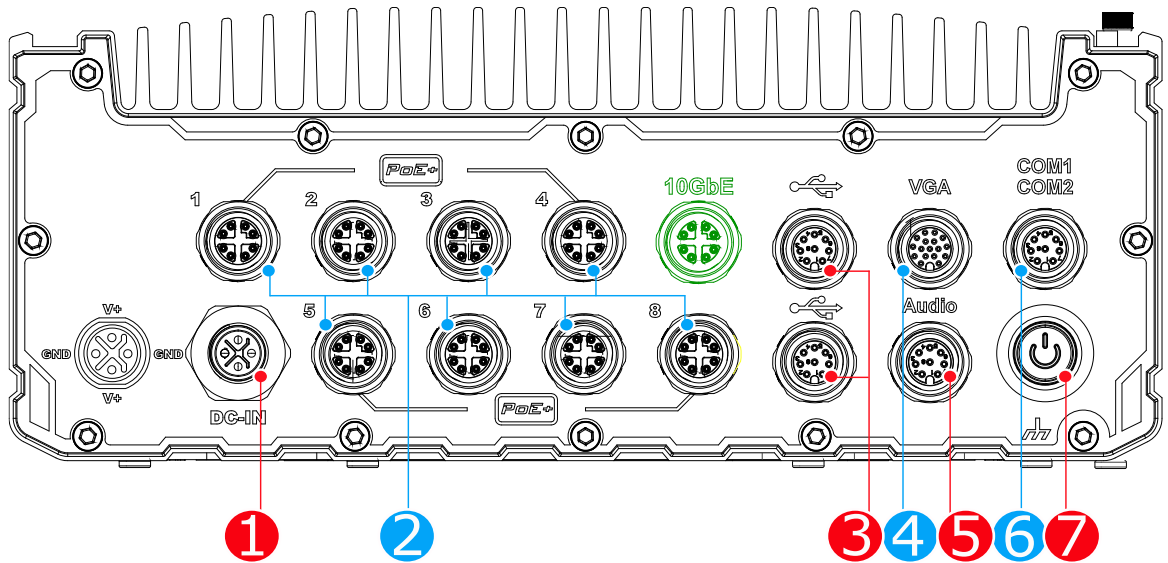

No.	Item	Description
1	DC input	8V to 48V DC input (M12 S-coded)
2	PoE+ GbE ports	SEMIL-1704 1x IEEE 802.3at GbE+ port via Intel® I219
		SEMIL-1714J 3x IEEE 802.3at GbE+ port via Intel® I210
		SEMIL-1708 1x IEEE 802.3at GbE+ port via Intel® I219
		SEMIL-1718J 7x IEEE 802.3at GbE+ port via Intel® I210
3	USB 2.0 port	SEMIL-1704 2x USB2.0 (M12 A-coded)
		SEMIL-1714J
		SEMIL-1708 4 x USB2.0 (M12 A-coded)
		SEMIL-1718J
4	VGA port	VGA output supports resolution up to 1920x1200@60Hz
5	Audio port	SEMIL-1704/ 1714J: Not applicable SEMIL-1714J/ 1718J: 1x mic-in and speaker-out (M12 A-coded)
6	COM ports	COM 1 & 2 are RS-232 ports via an M12 A-coded connector
7	Power button	Use this button to turn on or force shutdown the system.
	Optional 10Gb Ethernet	The optional 10GbE is backwards compatible with 5Gb, 2.5Gb, and GbE connections.

2.2.1 DC-IN Connector

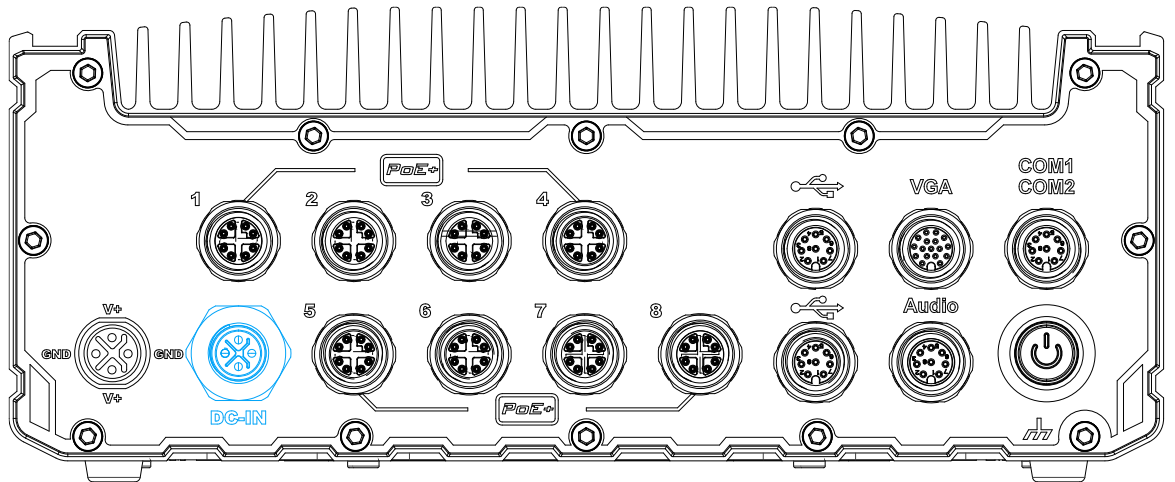

The system accepts a wide range of DC power input from 8 to 48V via a M12 S-coded connector. The M12 S-coded connectors offer COTS availability and ultra-rugged connection reliability when wiring DC power.

WARNING

Please make sure the voltage of DC power is correct before you connect it to the system. Supplying a voltage over 48V will damage the system.

Connector Pin Definition

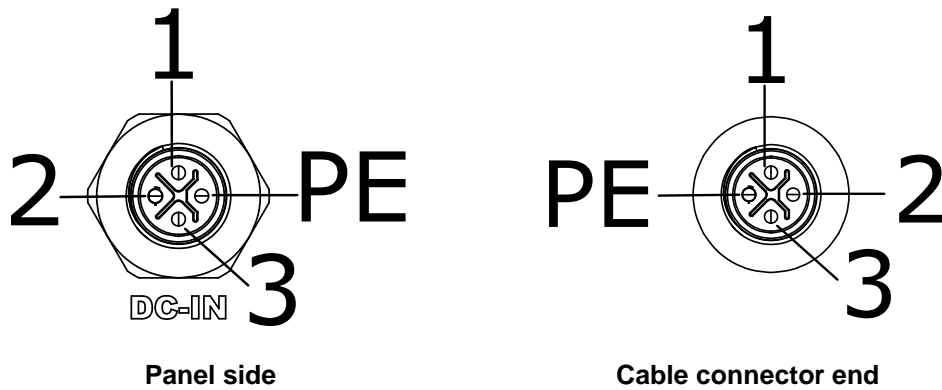

Signal	M12 panel side	M12 cable connector end	Wire color
V+	3	3	Blue
GND	2	2	White
V+	1	1	Orange
GND	PE	PE	Black

2.2.2 PoE+ Gigabit Ethernet Port

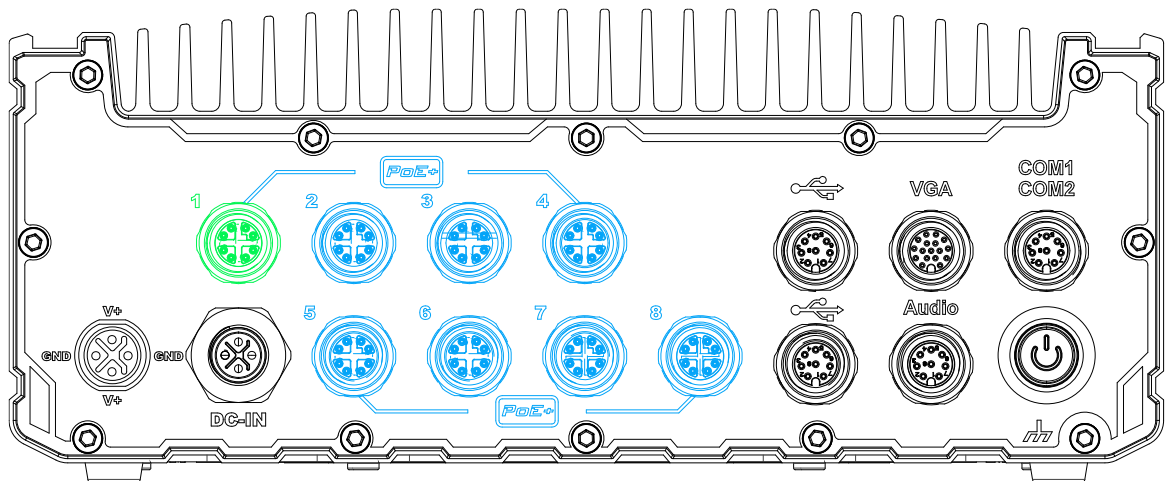

The system offers PoE+ GbE ports via M12 X-coded connectors on the front panel. The port marked in **green** is implemented using Intel® I219-LM controller that supports Wake-on-LAN and is also compatible with [Intel® AMT \(Active Management Technology\)](#) to support advanced features such as remote SOL desktop and remote on/ off control. Power over Ethernet (PoE) supplies electrical power and data on a CAT-5/CAT-6 Ethernet cable. Acting as a PoE PSE (Power Sourcing Equipment), compliant with IEEE 802.3at, each PoE port delivers up to 25.5W to a Powered Device (PD). PoE can automatically detect and determine if the connected device requires power or not, so it is compatible with standard Ethernet devices as well. Each port has one dedicated PCI Express link for maximum network performance.

The number of ports for each SEMIL-1700 model variant is listed below:

PoE+ ports Model No.	Port description
SEMIL-1704	1x IEEE 802.3at GbE+ port via Intel® I219 (port 1)
SEMIL-1714J	3x IEEE 802.3at GbE+ port via Intel® I210 (port 2 to 4)
SEMIL-1708	1x IEEE 802.3at GbE+ port via Intel® I219 (port 1)
SEMIL-1718J	7x IEEE 802.3at GbE+ port via Intel® I210 (port 2 to 8)

Connector Pin Definition

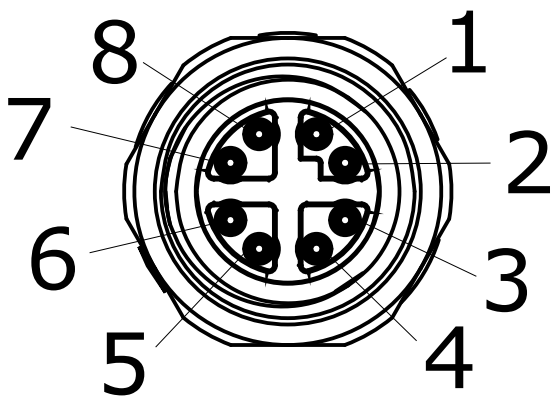

Panel side



Cable connector end

Signal	M12 panel side	M12 cable connector end	Wire color
LAN P0	1	1	Yellow
LAN N0	2	2	Yellow
LAN P1	3	3	Green
LAN N1	4	4	Green
LAN P3	5	5	Orange
LAN N3	6	6	Orange
LAN N2	7	7	Blue
LAN P2	8	8	Blue

2.2.3 USB Port

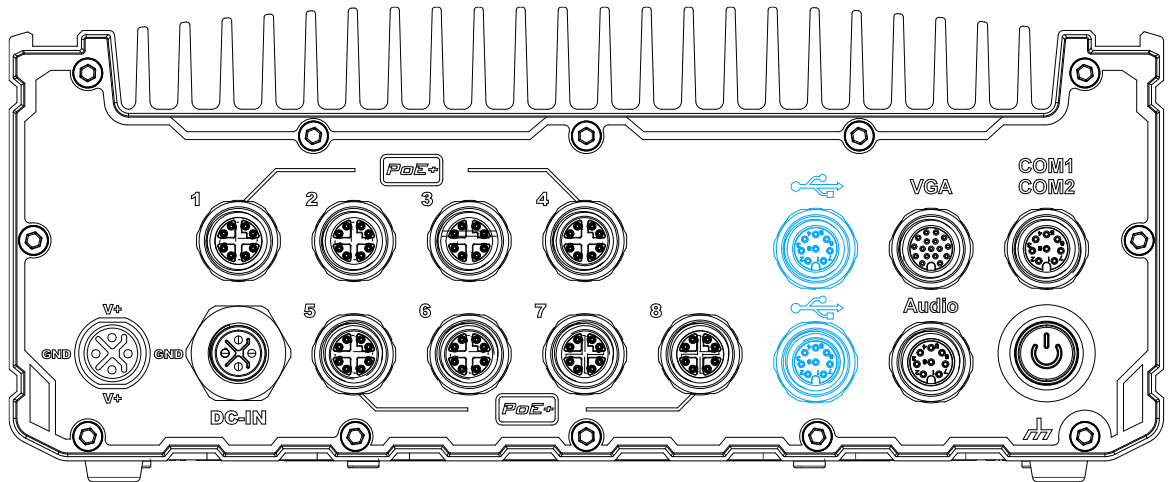

The USB2.0 ports are implemented via native xHCI (eXtensible Host Controller Interface) controller and are backward compatible with USB 1.1 and USB 1.0 devices. Legacy USB support is also provided so you can use USB keyboard/mouse in DOS environment.

Connector Pin Definition

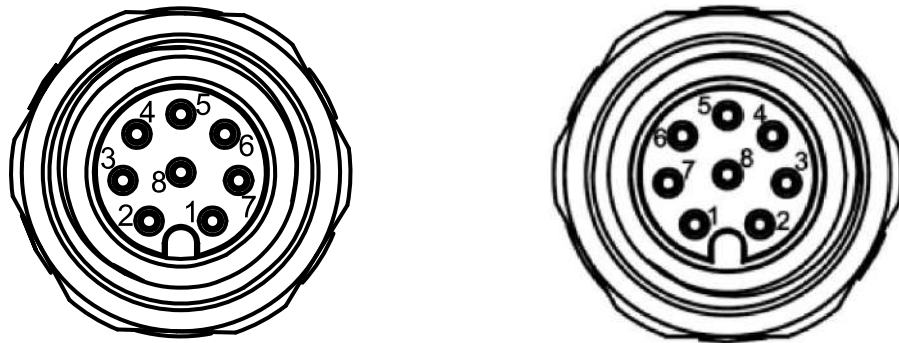

Signal	Panel side	Cable connector end	
	M12 panel side	M12 cable connector end	Wire color
D1+	1	1	Green
D1-	2	2	White
VCC_USB	3	3	Red
GND	4	4	Black
GND	5	5	Black
VCC_USB	6	6	Red
D2-	7	7	White
D2+	8	8	Green



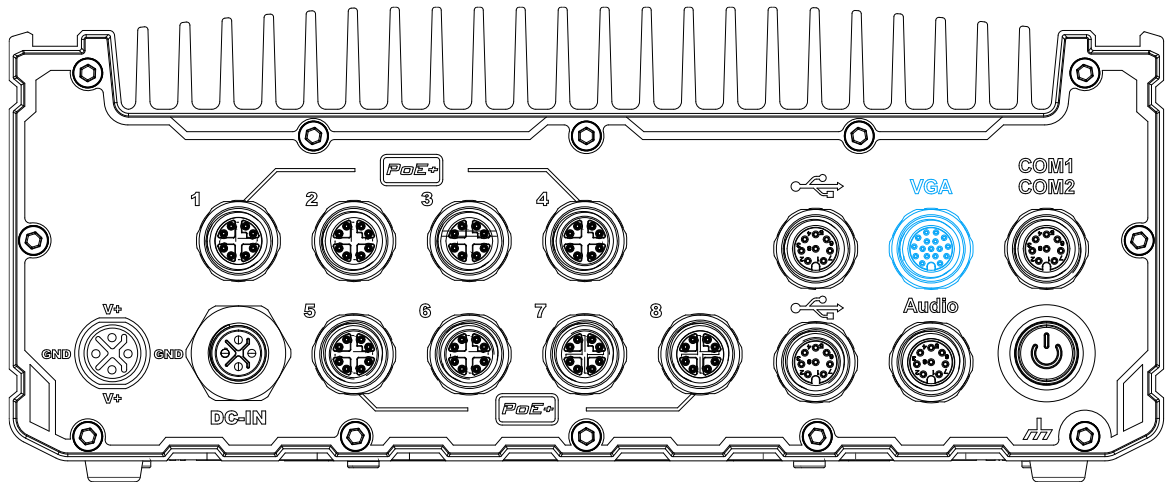





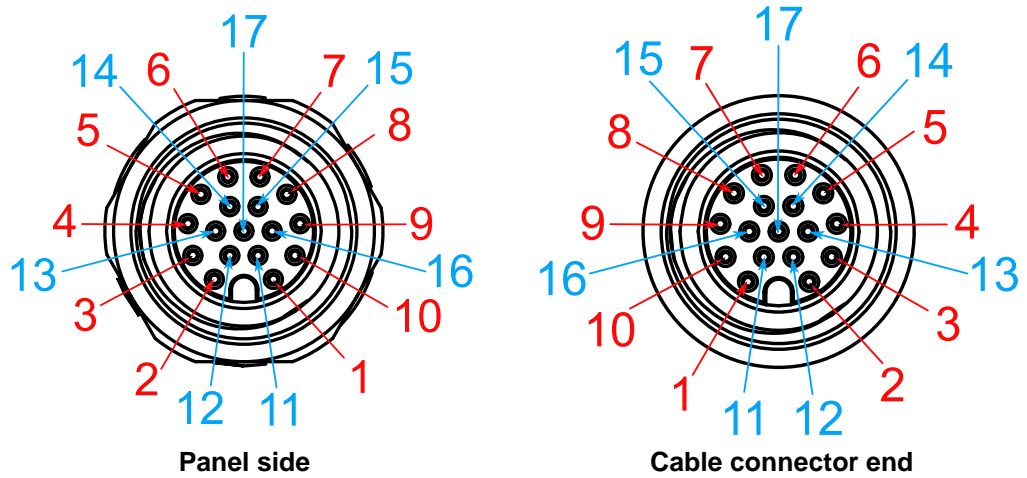

2.2.4 VGA Port















VGA connector is the most common video display connection. The VGA output supports up to 1920x1200@60Hz resolution. To support VGA display output and achieve best VGA output resolution in Windows, you need to install corresponding graphics drivers. Please refer to section [OS Support and Driver Installation](#) for details.

Connector Pin Definition



Signal	M12 panel side	M12 cable connector end	Wire color
Red	1	1	
GREEN	9	9	
BLUE	7	7	
GND	6	6	
GND	8	8	
GND	10	10	
GND	12	12	
GND	13	13	
GND	14	14	
GND	11	11	
GND	16	16	

GND	15	15		
P5V_VGA	17	17		
VGA_SDA	5	5		
HSYNC_CN	3	3		
VSYNC_CN	2	2		
VGA_SCL	4	4		



NOTE

Please make sure your VGA cable includes SDA and SCL (DDC clock and data) signals for correct communication with monitor to get resolution/timing information. A cable without SDA/ SCL can cause blank screen on your VGA monitor due to incorrect resolution/timing output.

2.2.5 Audio Port (SEMIL-17x8 Models Only)

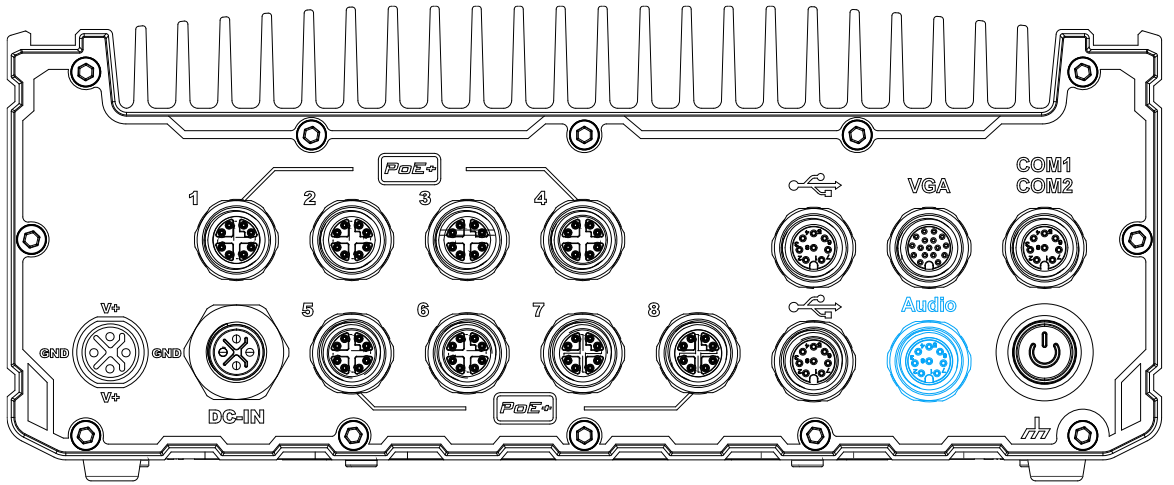

The M12 A-coded audio port accepts microphone voice input and headphone speaker sound output. To utilize the audio function in Windows, you need to install corresponding drivers for both motherboard and audio.

Pin Definition

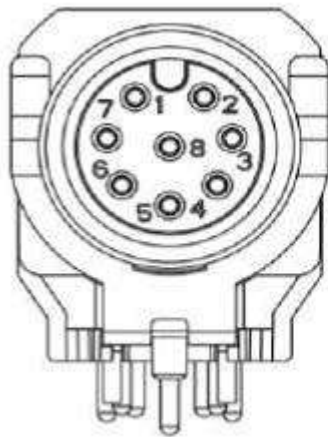

Socket end



Cable side

Signal	M12 Socket end	M12 cable side
Left channel	4	4
Right channel	5	5
Microphone	7	7
Ground	8	8

2.2.6 COM1/ COM2 Port

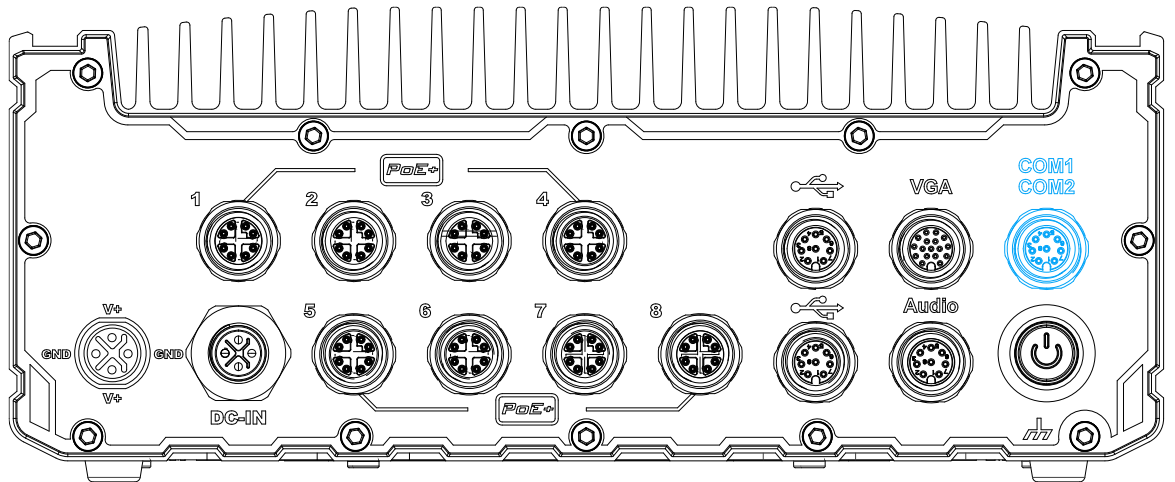

The system provides two COM ports via an M12 A-coded connector for communicating with external devices. These COM ports are 3-wire RS-232 specifications and provide up to 115200 bps baud rate.

Connector Pin Definition

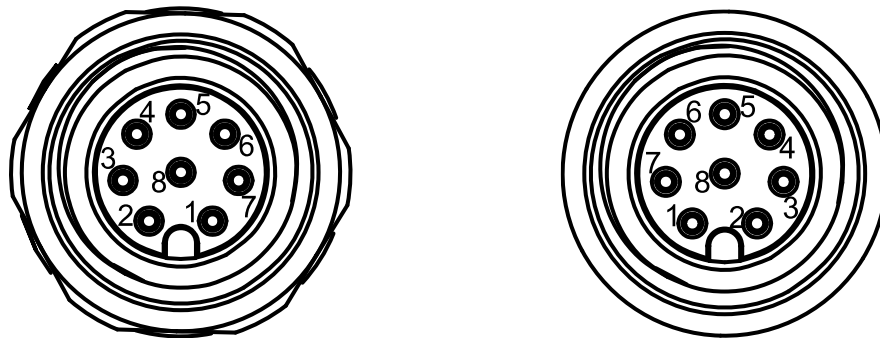

Signal	Panel side	Cable connector end	
	M12 panel side	M12 cable connector end	Wire color
TXD1	1	1	
RXD1	2	2	
NC	3	3	x
PWR_IGN	4	4	
GND	5	5	
NC	6	6	x
RXD2	7	7	
TXD2	8	8	

2.2.7 Power Button

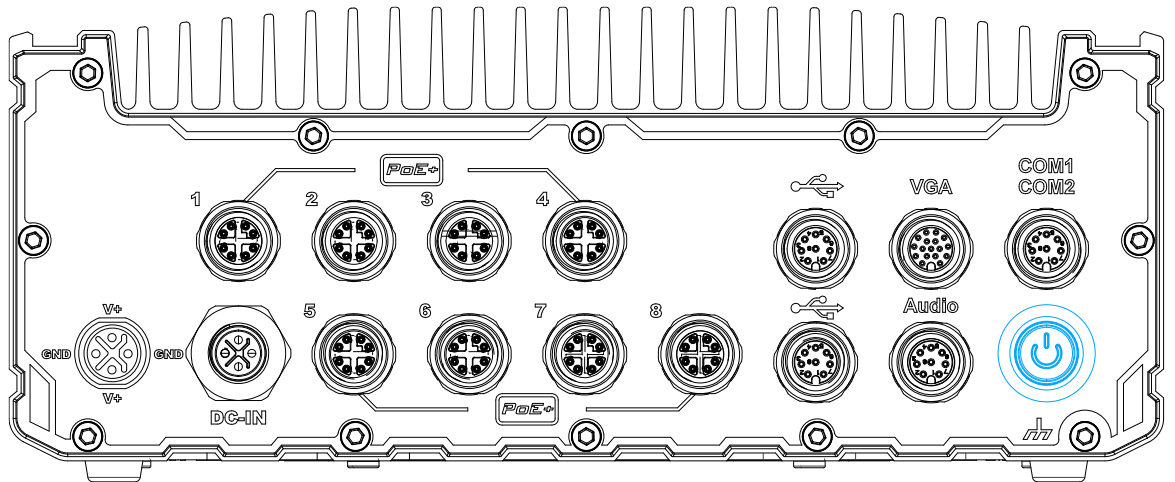

The power button is a non-latched switch for ATX mode on/off operation. To turn on the system, press the power button and the PWR LED should light-up green. To turn off the system, issuing a shutdown command in OS is preferred, or you can simply press the power button. To force shutdown when the system freezes, press and hold the power button for 5 seconds. Please note that there is a 5-second interval between on/off operations (i.e. once the system is turned off, there is a 5-second wait before you can power-on the system).

2.2.8 Optional 10Gb Ethernet

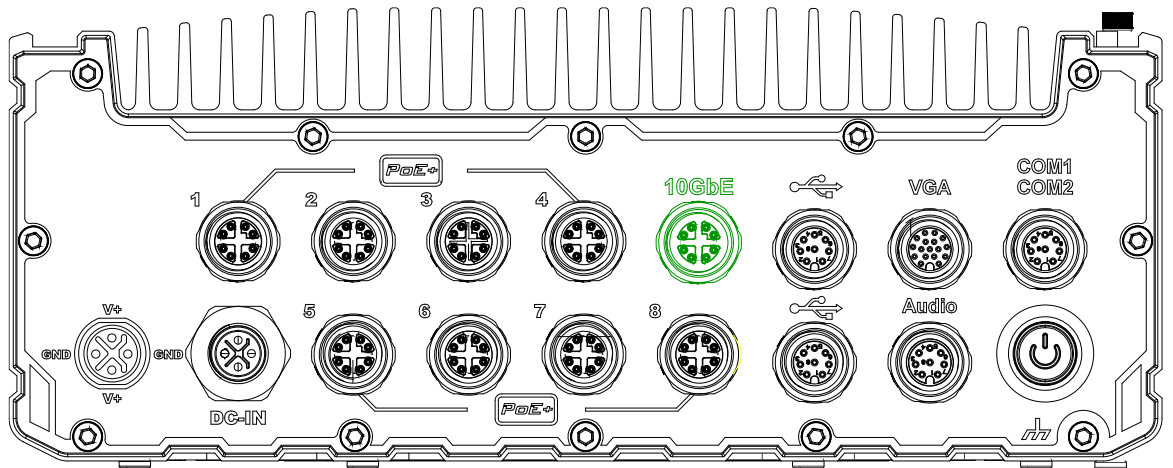

The system offers an optional 10Gb Ethernet via M12 X-coded connector (in green) implemented using Intel® X550AT controller on the front panel. The port is backwards compatible with 5Gb, 2.5Gb, and Gb Ethernet connections.

Connector Pin Definition

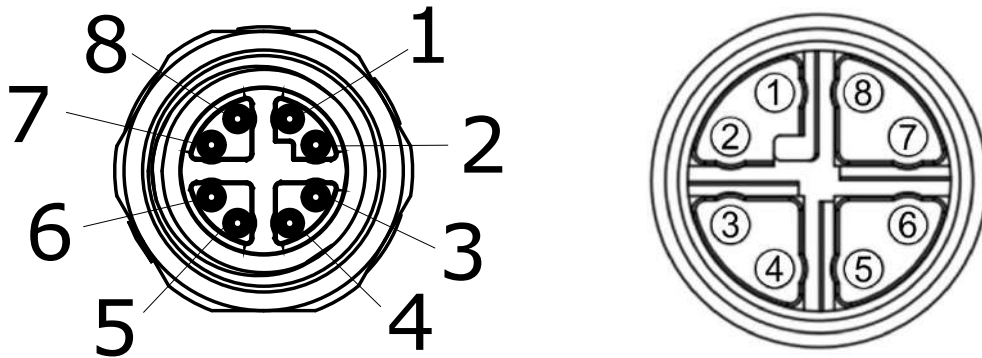

Signal	M12 panel side	M12 cable connector end	Wire color
LAN P0	1	1	Yellow
LAN N0	2	2	Yellow
LAN P1	3	3	Green
LAN N1	4	4	Green
LAN P3	5	5	Green
LAN N3	6	6	Green
LAN N2	7	7	Blue
LAN P2	8	8	Blue

2.3 Internal I/Os



NOTE

Installing after-sales internal modules on your own may affect its waterproof capabilities and is not recommended. If you must install internal wireless modules after purchase, please consult your sales representative as you may need to return the system to Neousys Technology or an authorized SEMIL distributor for antenna installation.

In addition to connectors on the enclosure panel, the system also provides internal expansion slots such as for hard drives, mini-PCIe, and access to ignition control rotary switch.

2.3.1 mini-PCIe Expansion Slot (mux with mSATA)

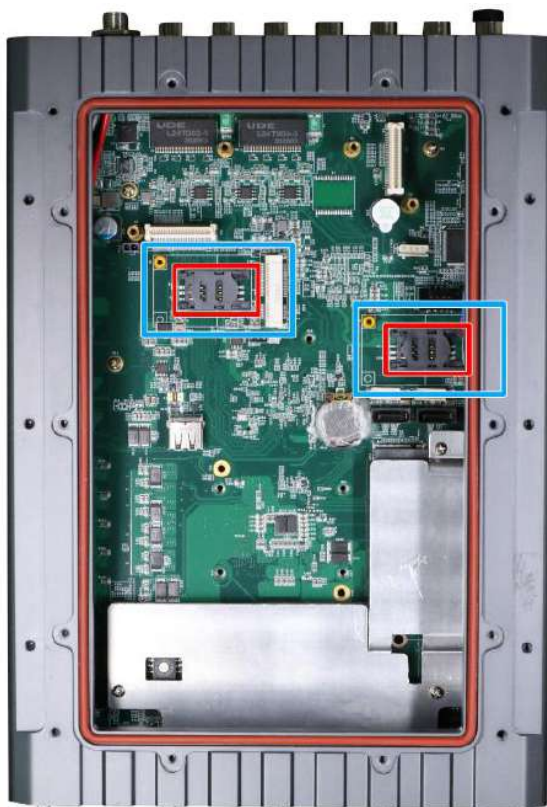

SEMIL-17x4 models

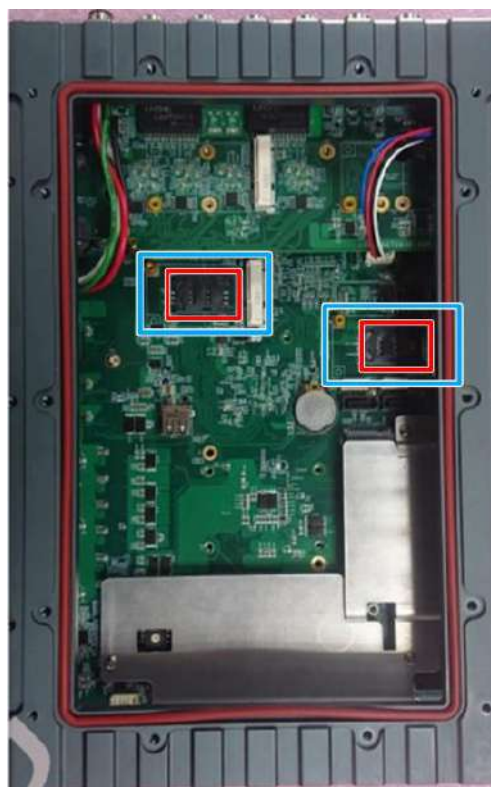

SEMIL-17x8 models

The system has two mini-PCIe sockets mux with mSATA. There are plenty of off-the-shelf mini-PCIe modules with versatile capabilities. By installing a mini-PCIe module, your system can have expanded features such as 5G/4G, WIFI, GPS, CAN bus, analog frame grabber, etc.

If the module is installed after initial purchase, you may need to return the unit to Neousys Technology or an authorized SEMIL distributor for SMA antenna installation.

mini-PCle slot definition

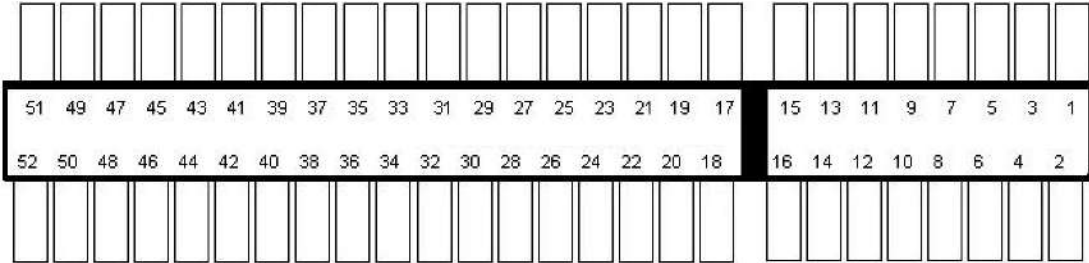

Pin #	Signal	Pin #	Signal
1	WAKE#	2	+3.3Vaux
3	COEX1	4	GND
5	COEX2	6	+1.5V
7	CLKREQ#	8	UIM_PWR
9	GND	10	UIM_DATA
11	REFCLK-	12	UIM_CLK
13	REFCLK+	14	UIM_RESET
15	GND	16	UIM_VPP
Mechanical Key			
17	Reserved* (UIM_C8)	18	GND
19	Reserved* (UIM_C4)	20	W_DISABLE#
21	GND	22	PERST#
23	PERn0	24	+3.3Vaux
25	PERp0	26	GND
27	GND	28	+1.5V
29	GND	30	SMB_CLK
31	PETn0	32	SMB_DATA
33	PETp0	34	GND
35	GND	36	USB_D-
37	GND	38	USB_D+
39	+3.3Vaux	40	GND
41	+3.3Vaux	42	LED_WWAN#
43	GND	44	LED_WLAN#
45	Reserved	46	LED_WPAN#
47	Reserved	48	+1.5V
49	Reserved	50	GND
51	Reserved	52	+3.3Vaux

2.3.2 mini-PCIe Expansion Slot (SEMIL-17x8 Models Only)

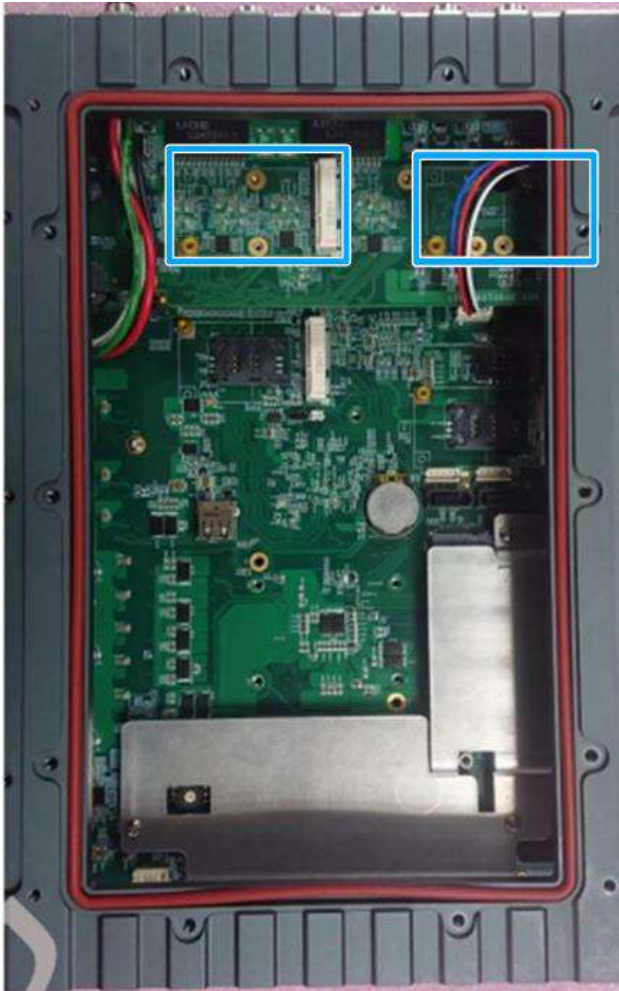

The SEMIL-17x8 systems have two mini-PCIe slots. There are plenty of off-the-shelf mini-PCIe modules with versatile capabilities. By installing a mini-PCIe module, your system can have expanded features such as WIFI, GPS, CAN bus, analog frame grabber, etc.

mini-PCle Slot Pin Definition

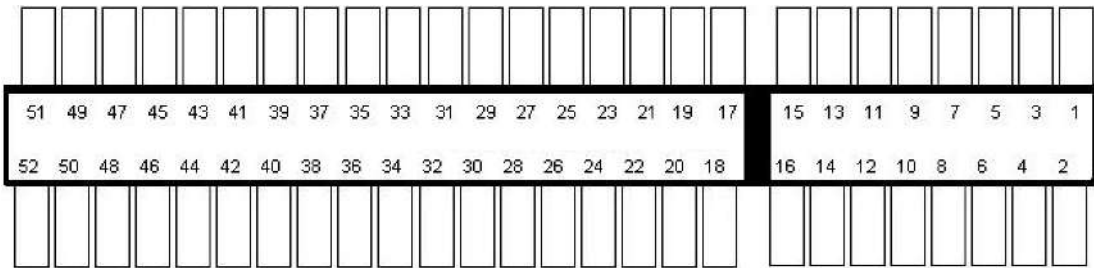

Pin #	Signal	Pin #	Signal
1	Reserved	2	+3.3Vaux
3	Reserved	4	GND
5	Reserved	6	+1.5V
7	Reserved	8	UIM_PWR
9	GND	10	UIM_DATA
11	Reserved	12	UIM_CLK
13	Reserved	14	UIM_RESET
15	GND	16	UIM_VPP
Mechanical Key			
17	Reserved	18	GND
19	Reserved	20	W_DISABLE#
21	GND	22	PERST#
23	Reserved	24	+3.3Vaux
25	Reserved	26	GND
27	GND	28	+1.5V
29	GND	30	Reserved
31	Reserved	32	Reserved
33	Reserved	34	GND
35	GND	36	USB_D-
37	GND	38	USB_D+
39	+3.3Vaux	40	GND
41	+3.3Vaux	42	LED_WWAN#
43	GND	44	LED_WLAN#
45	Reserved	46	LED_WPAN#
47	Reserved	48	+1.5V
49	Reserved	50	GND
51	Reserved	52	+3.3Vaux

2.3.3 Ignition Control Rotary Switch

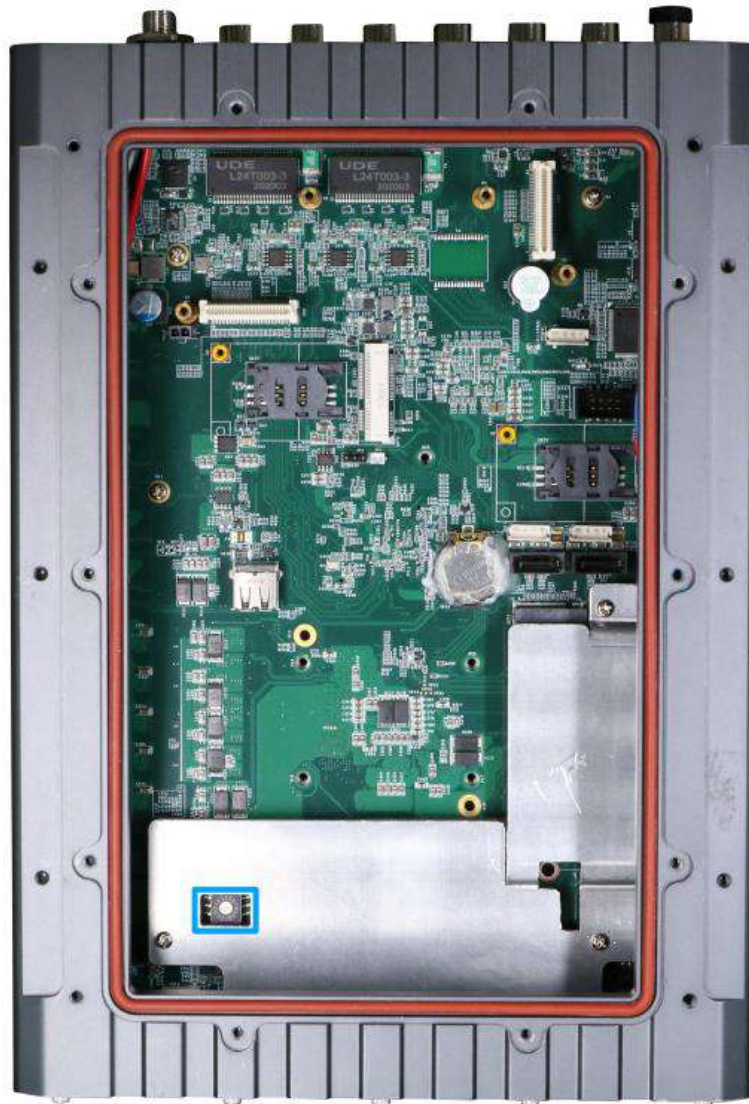

The ignition power control switch features multiple modes for pre and post ignition settings. Please refer to the section [Ignition Power Control](#) for details.

3 Installation

3.1 mini-PCle Module Installation



NOTE

Installing after-sales internal modules on your own may affect its waterproof capabilities and is not recommended. If you must install internal wireless modules after purchase, please consult your sales representative as you may need to return the system to Neousys Technology or an authorized SEMIL distributor for antenna installation.

To install or replace mini-PCle modules in the system, please refer to the following instructions:

1. Disconnect all cable connections and shut down the system.
2. Turn the system upside-down and place it on a flat sturdy surface.
3. Unscrew the indicated screws in descending order.

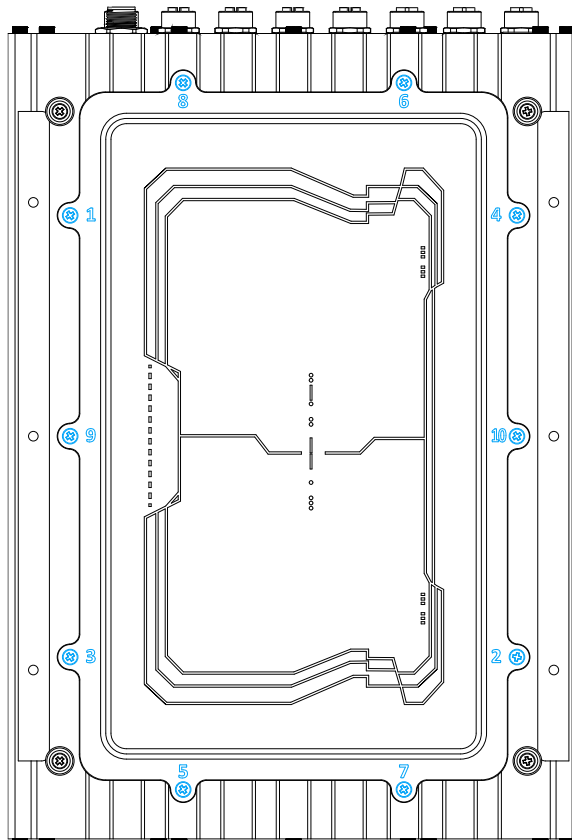

4. Gently lift the panel and you will see the internal components.

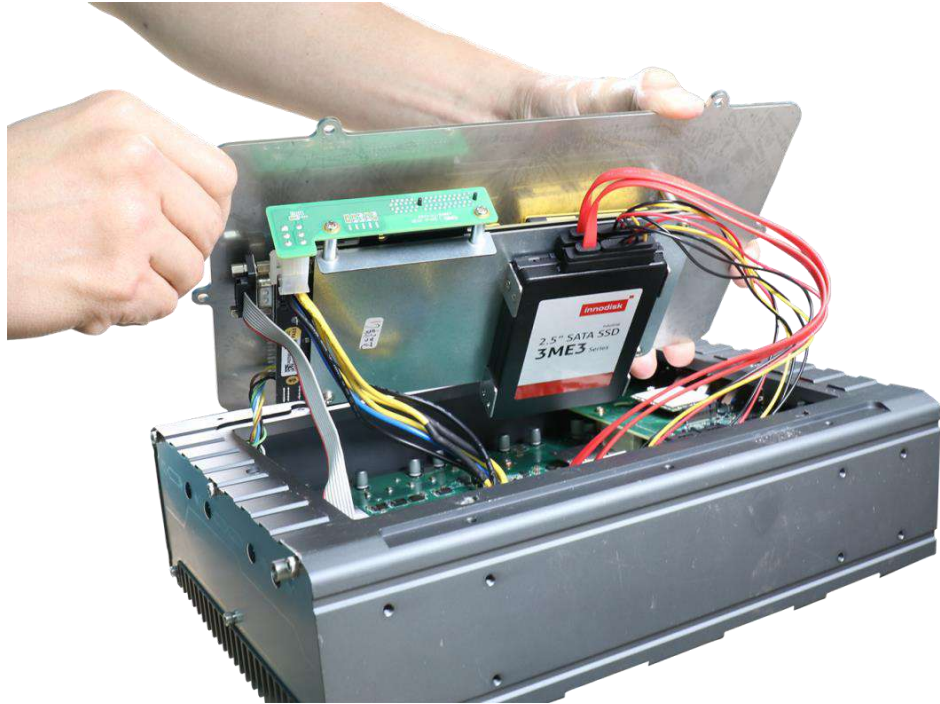

5. It is recommended that you disconnect the cables to better access and install components. Only SEMIL-17xxJ models will have PB supercap UPS module.

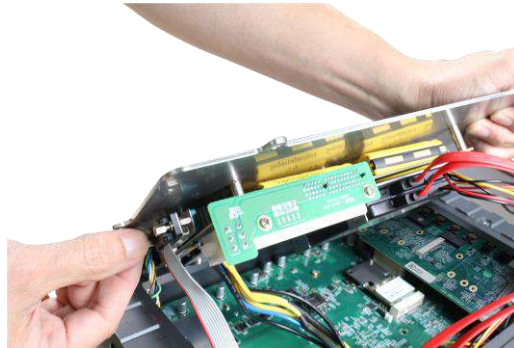

Unplug the DB9 connection to the PB unit



Unplug the 4-pin ATX connector



Disconnect the 4-pin power connector



Disconnect from the motherboard side

6. If hard drives are installed, disconnect the SATA/ power connector. Pull using the connector body, **DO NOT** pull on the cable!

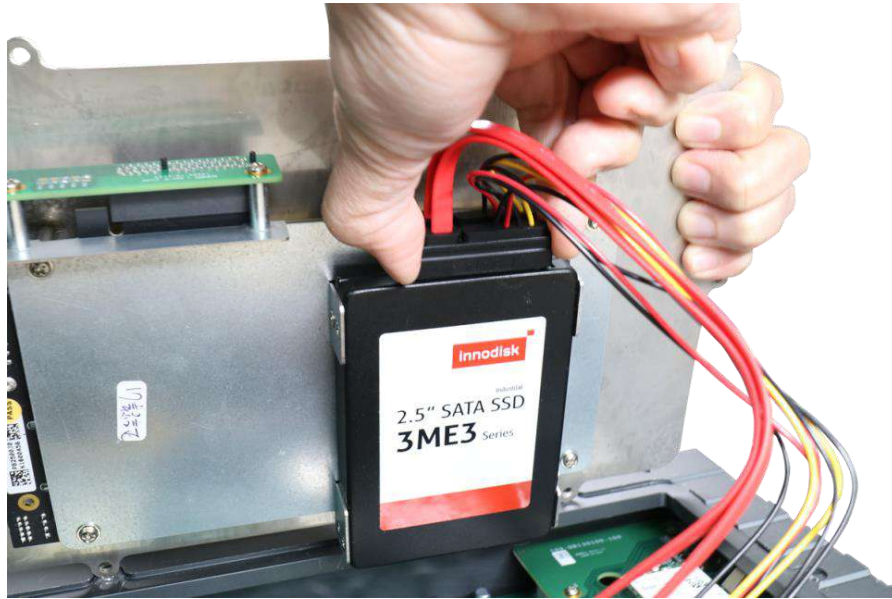

7. Identify the slot locations of the mini-PCle slots and their respective SIM slots.

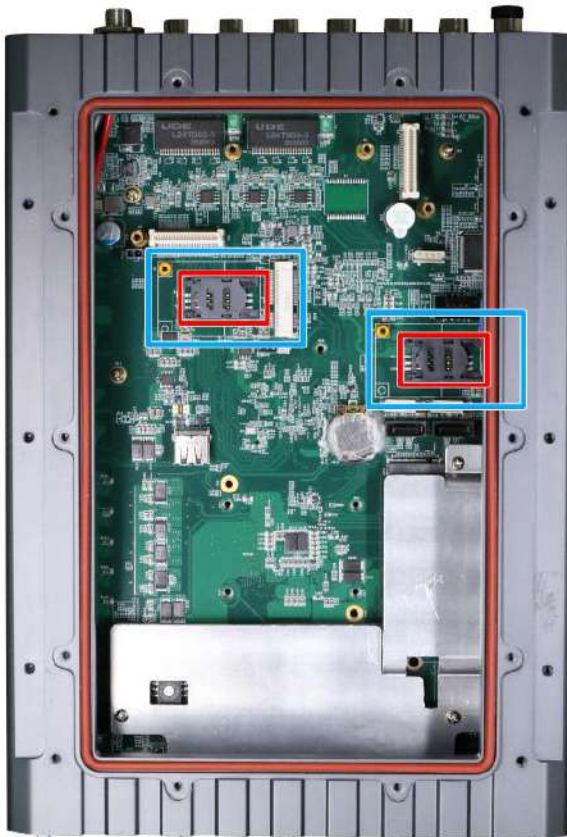

SEMIL-17x4 models

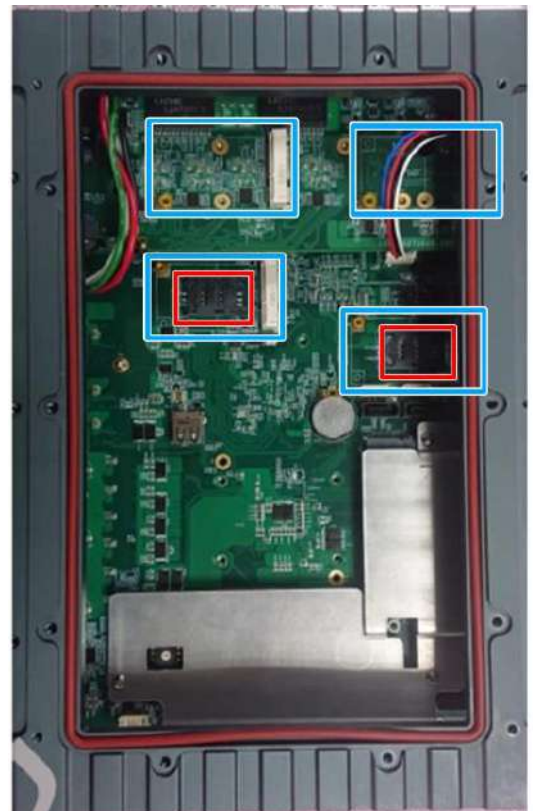

SEMIL-17x8 models

8. If you are installing 5G/ 4G mini-PCle modules, please install the respective SIM cards first.

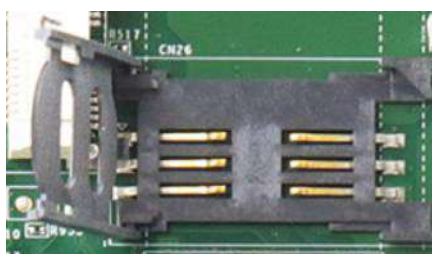

Slide and lift SIM card holder



Insert SIM card with pins facing up



Secure the SIM card by sliding the holder

9. To install mini-PCle module, simply insert the module into the slot on a 45 degree angle, press down and secure with a screw.



Insert into slot on a 45 degree angle



Secure the module with a screw

10. Refer to the module's manual and connect the antenna.



11. If the module is installed after initial purchase, you may need to return the unit to Neousys Technology or an authorized SEMIL distributor for SMA antenna installation.

12. Reconnect the cables for the PB module.

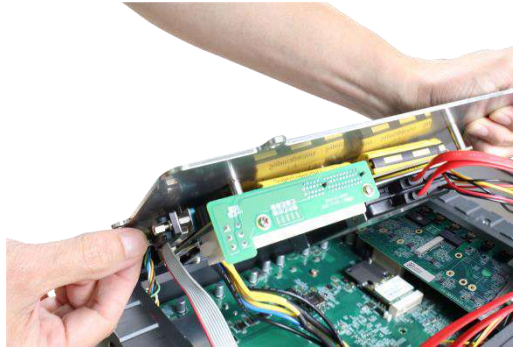

Connect the DB9 connection

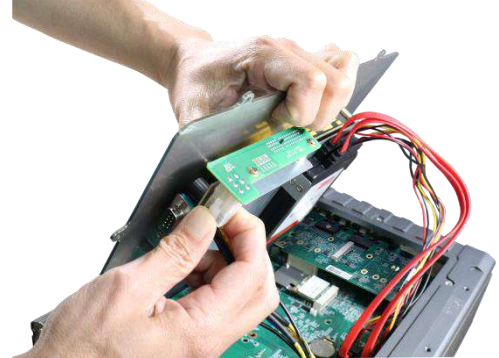

Plug in the 4-pin ATX connector



Connect the 4-pin power connector



Connect from the motherboard side

13. Make sure the O-ring seal is properly seated in the groove.

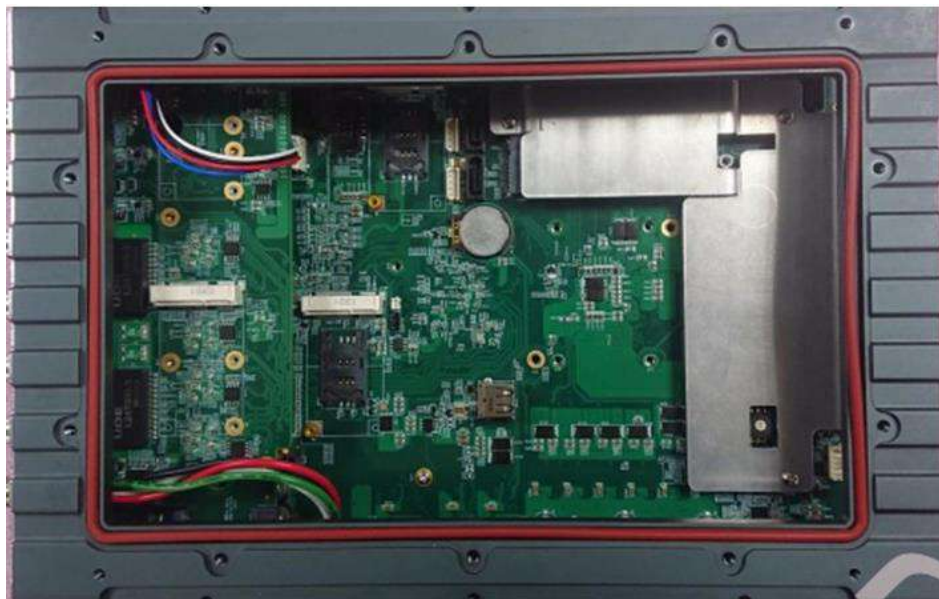

14. Gently tug all the cables into the enclosure and shut the bottom panel back on.

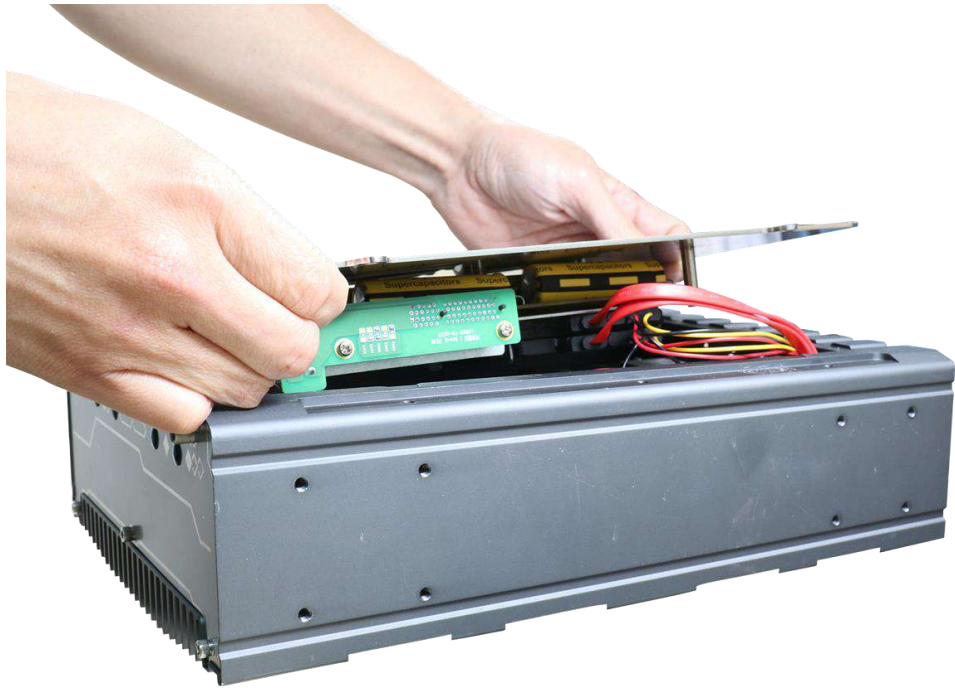

15. Secure the indicated screws at a torque range of 6.3 – 7.7kgf-cm in ascending order to complete the HDD installation procedure.

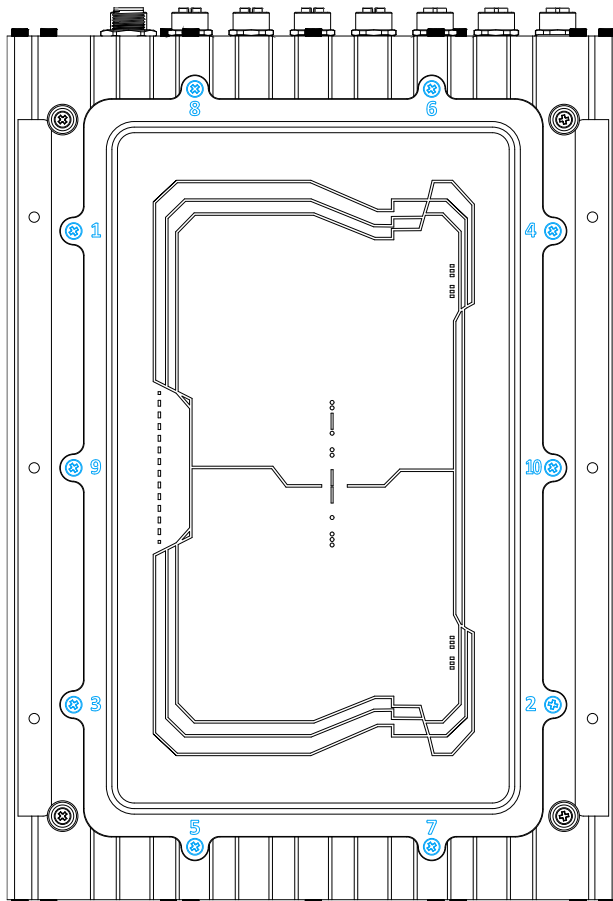

3.2 Hard Drive Installation



NOTE

Installing after-sales internal modules on your own may affect its waterproof capabilities and is not recommended. If you must install internal wireless modules after purchase, please consult your sales representative as you may need to return the system to Neousys Technology or an authorized SEMIL distributor for antenna installation.

To install or replace hard drives in the system, please refer to the following instructions:

1. Disconnect all cable connections and shut down the system.
2. Turn the system upside-down and place it on a flat sturdy surface.
3. Unscrew the indicated screws in descending order.

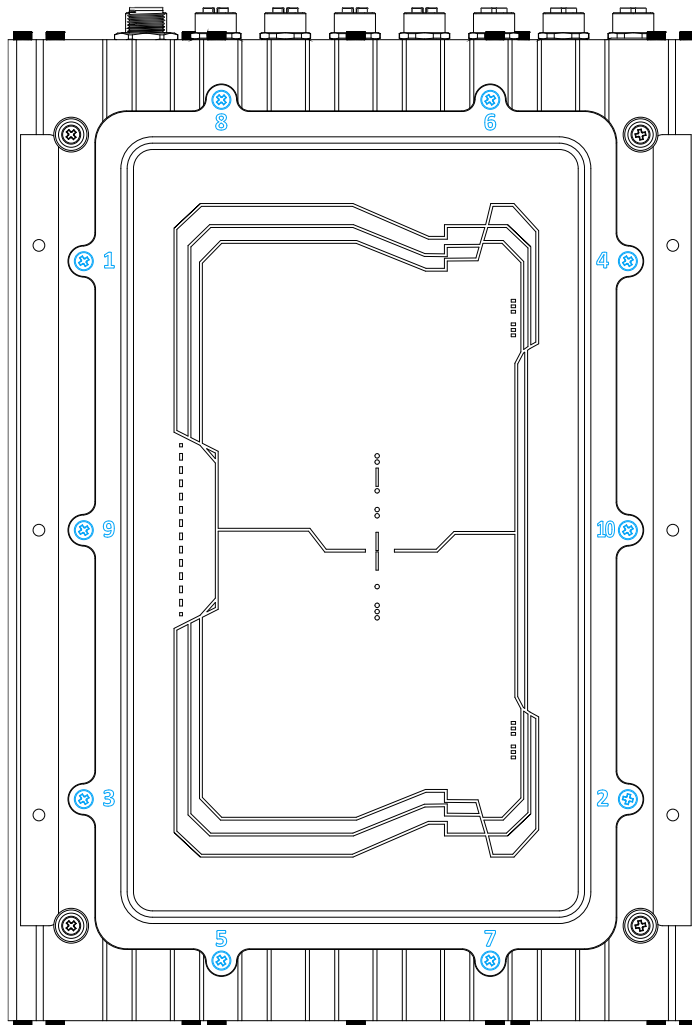

4. Gently lift the panel and you will see the internal components.

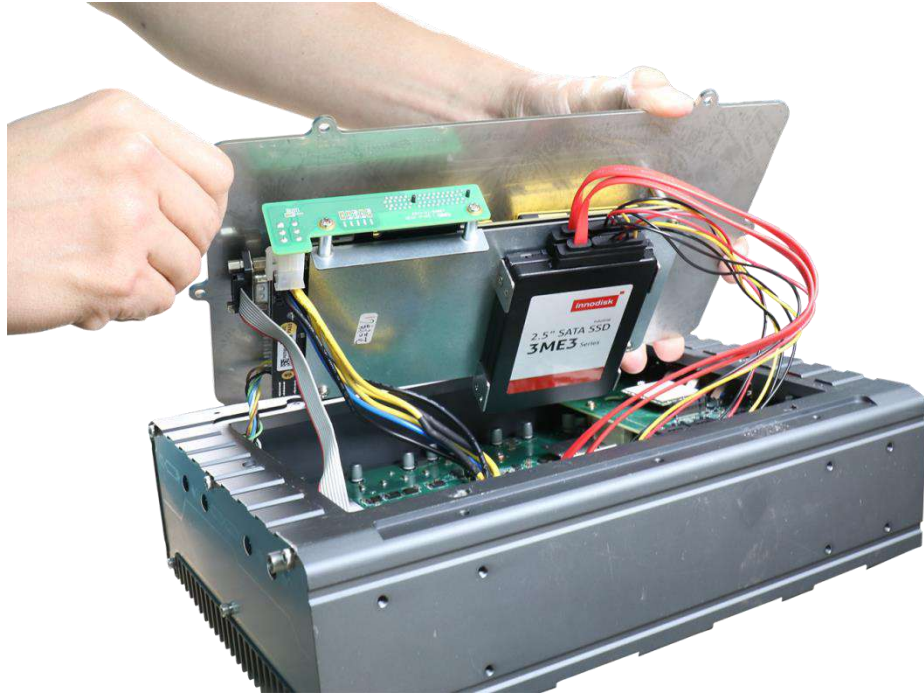

5. It is recommended that you disconnect the cables to better access and install components.

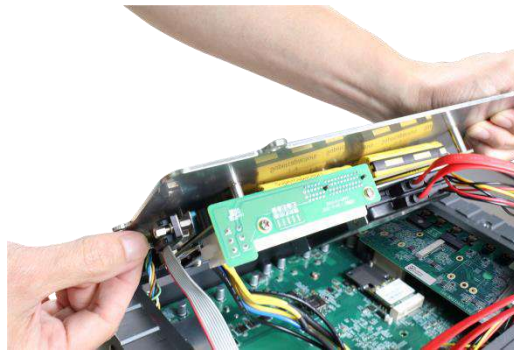

Unplug the DB9 connection to the PB unit

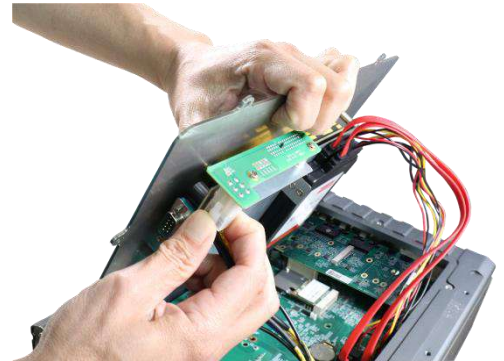

Unplug the 4-pin ATX connector



Disconnect the 4-pin power connector



Disconnect from the motherboard side

- If you are replacing existing HDD, disconnect the SATA/ power connector. Pull using the connector body, **DO NOT** pull on the cable!



Disconnect the SATA/ power connector



Remove screws on both sides of the hard drive

- Place the hard drive in between the brackets and secure with screws on both sides. Repeat this step if you are installing a second HDD.



Place hard drive in between brackets



Secure hard drive with screws on both sides

- Connect the SATA/ power cable onto the HDDs.



Connect the bottom hard drive first



Then connect the hard drive on top (if installed)

9. Reconnect the cables for the PB module.

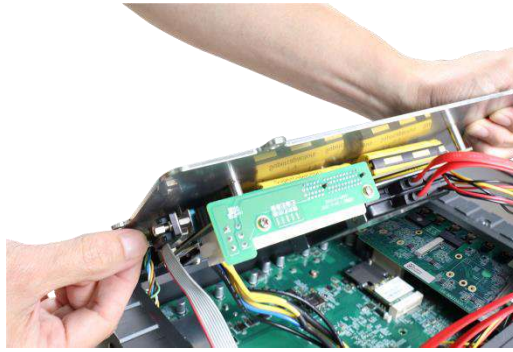

Connect the DB9 connection

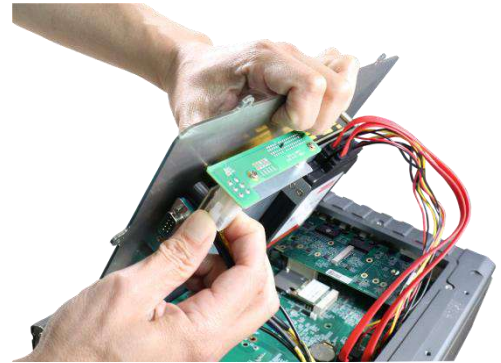

Plug in the 4-pin ATX connector



Connect the 4-pin power connector



Connect from the motherboard side

10. Make sure the O-ring seal is properly seated in the groove.

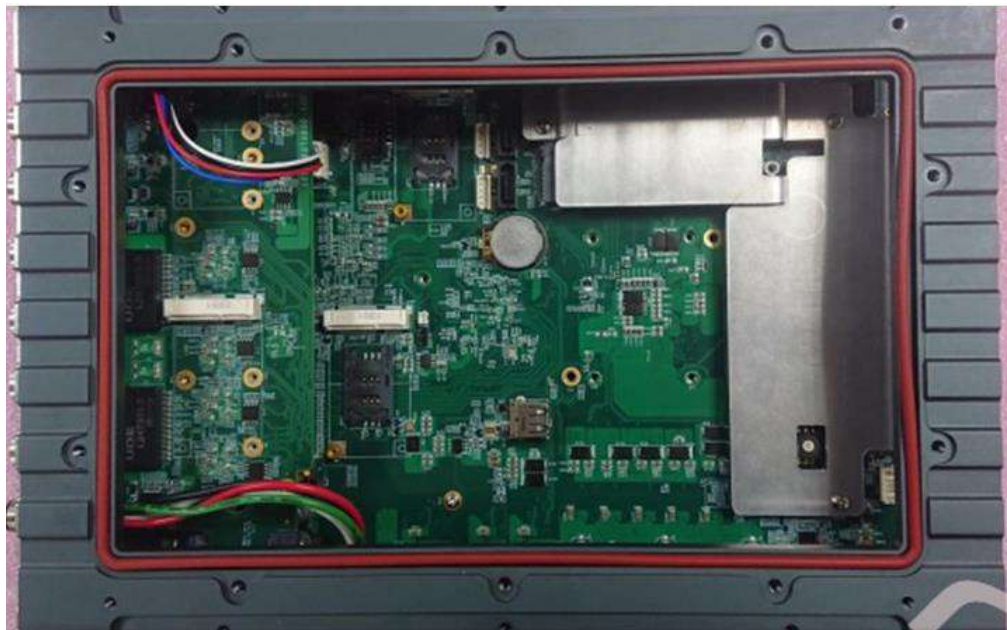

11. Gently tug all the cables into the enclosure and shut the bottom panel back on.

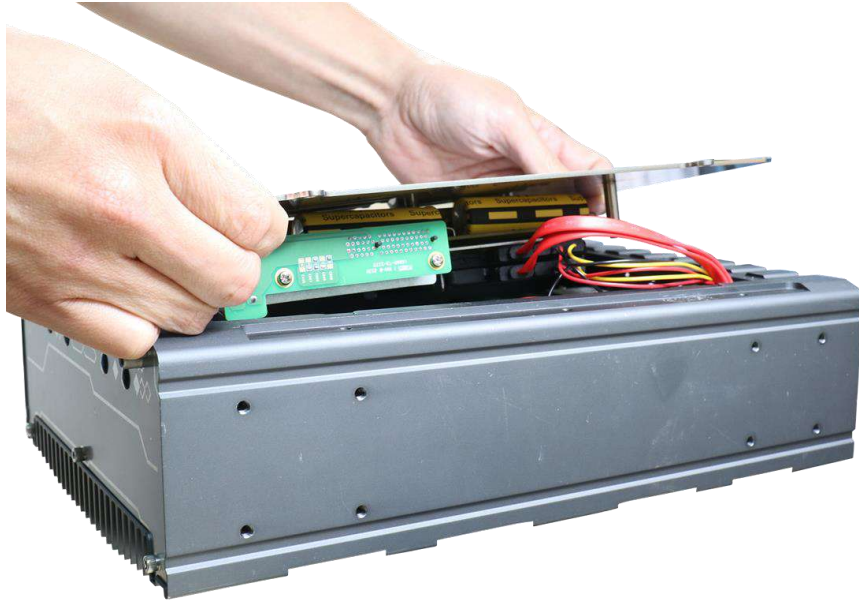

12. Secure the indicated screws at a torque range of 6.3 – 7.7 kgf-cm in ascending order to complete the HDD installation procedure.

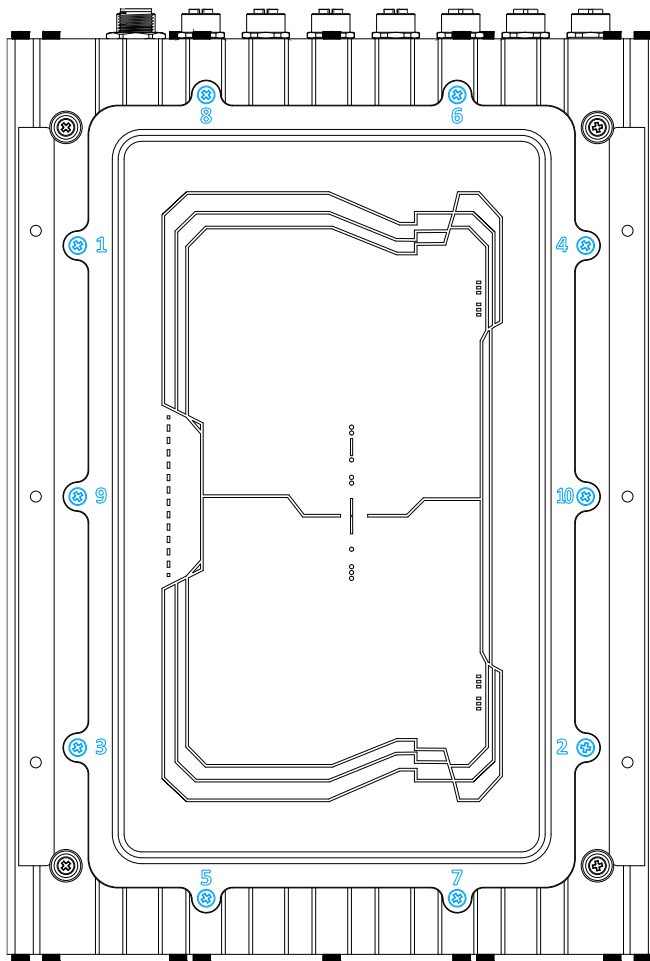

3.3 Wall-mount Bracket Installation

The system comes with four wall-mount installation brackets. The four brackets are interchangeable and can be installed on any of the four locations designated for bracket installation. Please follow the procedures below to install the brackets.

1. Remove the four brackets and sixteen screws from the accessory box.
2. To install the bracket (in **red**), simply secure it using the screws (in **blue**) provided.

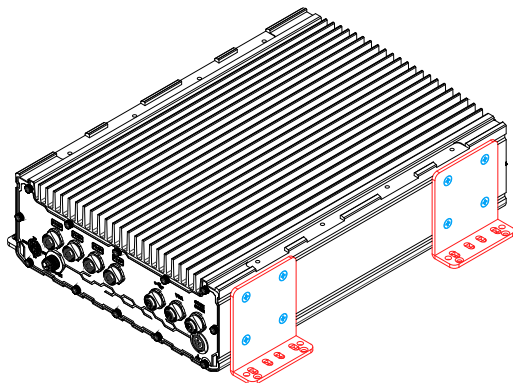

Left side bracket

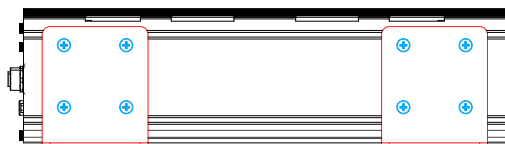

Left side view

3. Repeat the same bracket installation on the other side of the enclosure.

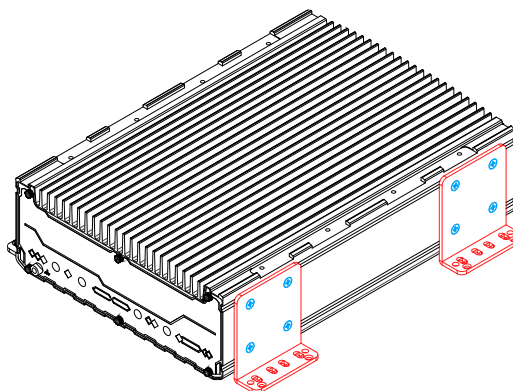

Rear 45 degree view

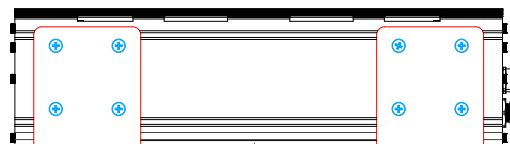

Right side view

3.4 Rack-mount Bracket Installation (Optional Accessory)

The system comes with optional rack-mount brackets. The two brackets can be installed so the system can be mounted into a standard 19" server cabinet. Please follow the procedures below to install the brackets.

1. There are two brackets (in **red**), two grips (in **green**) and eight screws (in **blue**) for this kit.
2. The larger-sized bracket (in **red**) is to be installed on the left side (next to the COM port side) of the enclosure with the screws (in **blue**) supplied.

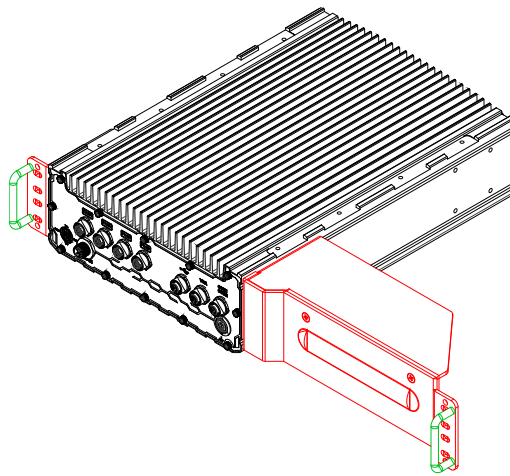

Left side bracket

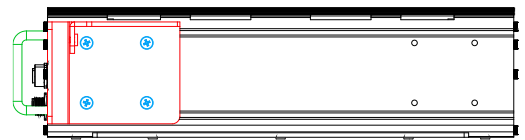

Screws securing the bracket

3. Secure the smaller bracket (in **red**) with the four screws (in **blue**) supplied. The grips (in **green**) are an optional accessory. They can be installed by securing the screws from the back of the bracket.

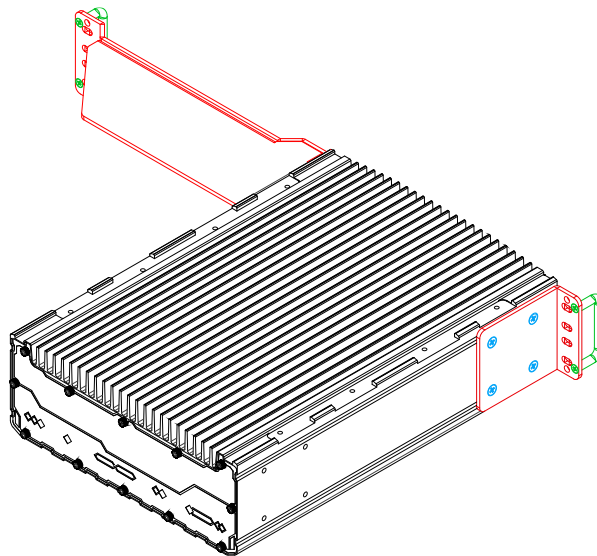

Rear view

4 Ignition Power Control

The ignition power control module for in-vehicle applications is a MCU-based implementation that monitors the ignition signal and reacts to turn on/off the system according to predefined on/off delay. Its built-in algorithm supports other features such as ultra-low power standby, battery-low protection, system hard-off, etc. In this section, we'll illustrate the principle of ignition power control and operation modes.

4.1 Principles of Ignition Power Control

The basic concept of ignition power control module is to control the timing correlation between ignition signal and system power status. A typical timing correlation is described in following diagram.

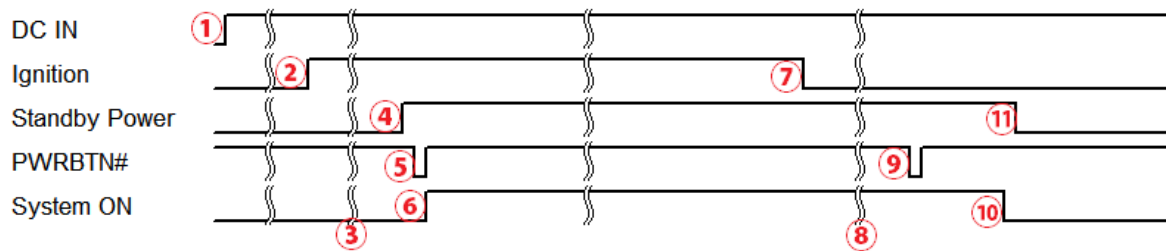

1. When DC power is supplied to the system, MCU starts to periodically detect ignition signal. Note that only MCU is working at this moment and the overall power consumption is less than 2 mW.
2. Ignition signal is active (both 12VDC and 24VDC ignition signals are accepted).
3. MCU starts to count a pre-defined power-on delay.
4. Once power-on delay expired, MCU turns on necessary standby power for the system (3.3VSB & 5VSB).
5. A PWRBTN# pulse is then issued to turn on the system (equivalent to one pressing the power button on the front panel).
6. The system is booting and becomes operational.
7. After a period of time, the ignition signal becomes inactive.
8. MCU starts to count a pre-defined power-off delay.
9. Once power-off delay expired, another PWRBTN# pulse is issued to perform a soft-off for the system (ex. a normal shutdown process for Windows system).
10. The system is completely shut down.
11. As MCU detects system is off, it turns off the standby power for the system, and operates in low power mode again (< 2mW power consumption).

4.2 Additional Features of Ignition Power Control

In addition to the typical timing correlation, the ignition power control module offers additional features to provide additional reliability for in-vehicle applications.

1. Low battery detection

The ignition power control module continuously monitors the voltage of DC input when the system is operational. If input voltage is less than 11V (for 12VDC input) or less than 22V (for 24VDC input) over a 60-second duration, it will shut down the system automatically.

2. Guarded power-on/ power-off delay duration

If ignition signal goes inactive during the power-on delay duration, the ignition power control module will cancel the power-on delay process and go back to idle status. Likewise if ignition signal goes active during the power-off delay duration, the ignition power control module will cancel the power-off delay process and keep the system running.

3. System hard-off

In some cases, system may fail to shutdown via a soft-off operation due to system/application halts. The ignition power control module offers a mechanism called "hard-off" to handle this unexpected condition. By detecting the system status, it can determine whether the system is shutting down normally. If not, the ignition power control module will force cut-off the system power 10 minutes after the power-off delay duration.

4. Smart off-delay

The ignition power control module offers two modes (mode 13 & mode 14) which have very long power-off delay duration for applications require additional off-line time to process after the vehicle has stopped. In these two modes, the ignition power control module will automatically detect the system status during the power-off delay duration. If the system has shutdown (by the application software) prior to power-off delay expiring, it will cut off the system power immediately to prevent further battery consumption.

4.3 Wiring Ignition Signal

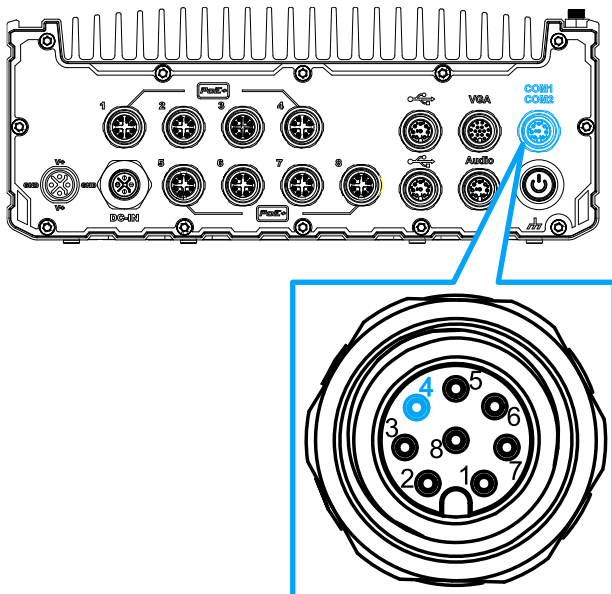

Connector Pin Definition

Signal	M12 panel side	Wire color
TXD1	1	
RXD1	2	
NC	3	x
PWR_IGN	4	
GND	5	
NC	6	x
RXD2	7	
TXD2	8	

To have ignition power control for in-vehicle usage, you need to supply IGN signal to the system. The IGN input is located on Pin 4, within the M12 A-coded COM1/ 2 port. Below is the typical wiring configuration for in-vehicle applications.

1. Connect car Battery+ line (12V for sedan, 24V for bus/truck) to V+.
2. Connect car Batter-/ GND line to GND.
3. Connect ACC line to IGN.

4.4 Configure your Windows system

When applying ignition power control to your system, please make sure you've configured your Windows system to initiate a shutdown process when pressing the power button. By default, Windows 7/ 8/ 10 goes to sleep (S3) mode when power button is pressed. As sleep (S3) is not a complete shutdown behavior, the ignition control function does not recognize the finish of a normal shut down process and thus users will encounter a system hard-off (power cut-off after 10 minutes). Please configure "When I press the power button" to "Shut down" in your Windows system settings.

Power button settings

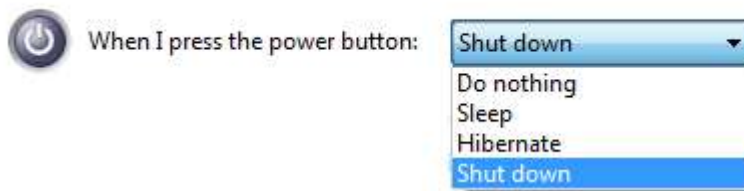

4.5 Accessing the Rotary Switch

To access the rotary switch, please refer to the section Disassembling the System.

1. Please power off the system and disconnect all cables connected to the system. Place the system upside-down on a steady surface. Remove the ten (10) screws indicated, and safe keep for later use. Please separate the backplate from the system's enclosure.



2. The ignition control rotary switch can be located on the motherboard, shown below.

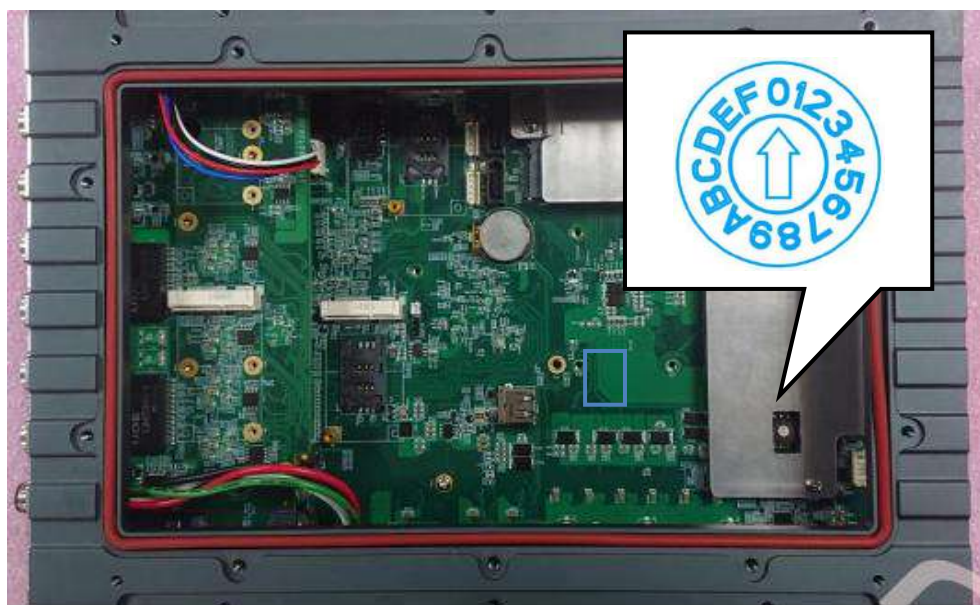

4.6 Operation Modes of Ignition Power Control

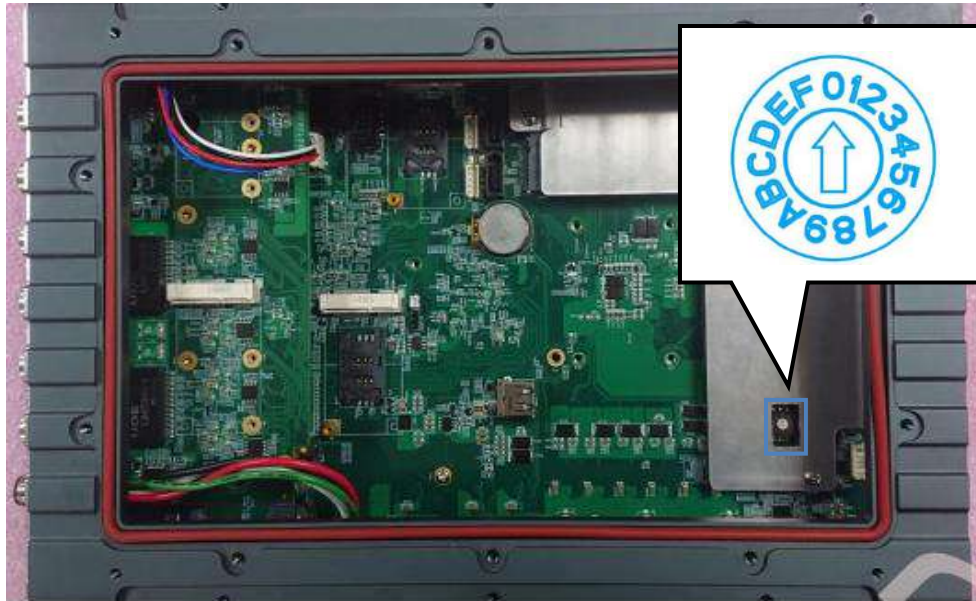

You can use the rotary switch to configure the operation mode. The system offers 16 (0~15) operation modes with different power-on/power-off delay configurations.

- **Mode 0**

Mode 0 is the ATX mode without power-on and power-off delay. User can only use the power button on the front panel to turn on or turn off the system.

Mode	Power-on Delay	Power-off Delay	Hard-off Timeout
0	N/A	N/A	N/A

- **Mode 1**

Mode 1 is AT mode without power-on and power-off delay. The system automatically turns on when DC power is applied. A retry mechanism is designed to repeat the power-on cycle if the system fails to boot up.

Mode	Power-on Delay	Power-off Delay	Hard-off Timeout
1	N/A	N/A	N/A

- **Mode 2**

Mode 2 is designed to have a very minor power on/ off delay of 160ms for applications that requires the system to start up almost at the same as the rest of the equipment it is working in collaboration with.

Mode	Power-on Delay	Power-off Delay	Hard-off Timeout
2	160ms	160ms	10 minutes

- **Mode 3 ~ Mode 12**

Mode 3 ~ Mode 12 have various power-on delay and power-off delay. Each mode supports a hard-off timeout of 10 minutes.

Mode	Power-on Delay	Power-off Delay	Hard-off Timeout
3	10 seconds	10 seconds	10 minutes
4	10 seconds	1 minute	10 minutes
5	10 seconds	5 minutes	10 minutes
6	30 seconds	1 minute	10 minutes
7	30 seconds	5 minutes	10 minutes
8	30 seconds	10 minutes	10 minutes
9	3 minutes	1 minute	10 minutes
10 (A)	3 minutes	10 minutes	10 minutes
11 (B)	3 minutes	30 minutes	10 minutes
12 (C)	10 minutes	30 minutes	10 minutes

- **Mode 13 (D) / Mode 14 (E)**

Mode 13 and Mode 14 are ignition power control modes with very long power-off delay. Both modes support the feature of “smart off-delay”, which automatically detect system status during power-off delay duration and cut off system power if system is off in prior to power-off delay expired.

Mode	Power-on Delay	Power-off Delay	Hard-off Timeout
13 (D)	30 seconds	2 hours	10 minutes
14 (E)	3 minutes	2 hours	10 minutes
15 (F)	Reserved		

4.7 Reinstalling the Backplate

1. Once you have configured the ignition rotary switch, you are ready to re-secure the backplate.
2. Before doing so, please make sure the O-ring is properly seated in the groove around the chassis edges.
3. Please attached the backplate, and secure the plate using the original ten screws in the following incremental order, and at the torque force specified.



NOTE

The recommended torque range for screws is 6.3 to 7.7 kgf-cm



O-ring seated properly in the groove



Attach the backplate, incremental screw order, and at a specified torque range (6.3 to 7.7 kgf-cm)

4.8 Ignition Control Setup

The following procedure demonstrates how to remove the backplate of a SEMIL-17XX series to gain access to the ignition control rotary switch.

3. Please power off the system and disconnect all cables connected to the system. Place the system upside-down on a steady surface. Remove the ten (10) screws indicated, and safe keep for later use. Please separate the backplate from the system's enclosure.

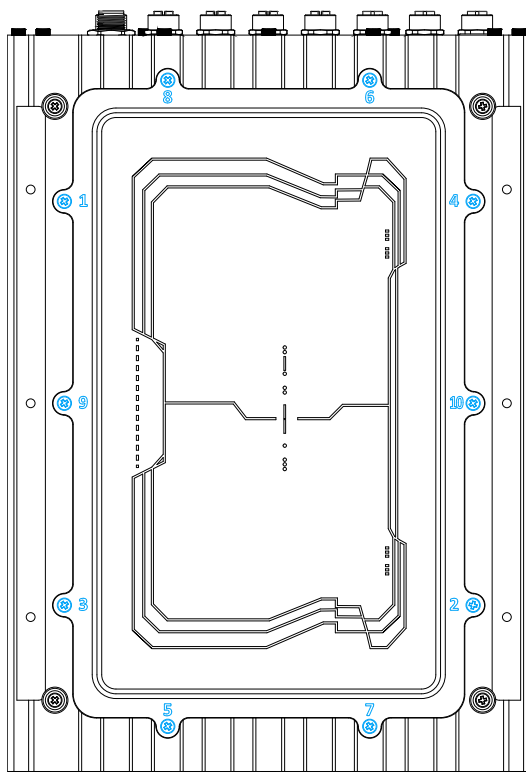

4. The ignition control rotary switch can be located on the motherboard, shown below.

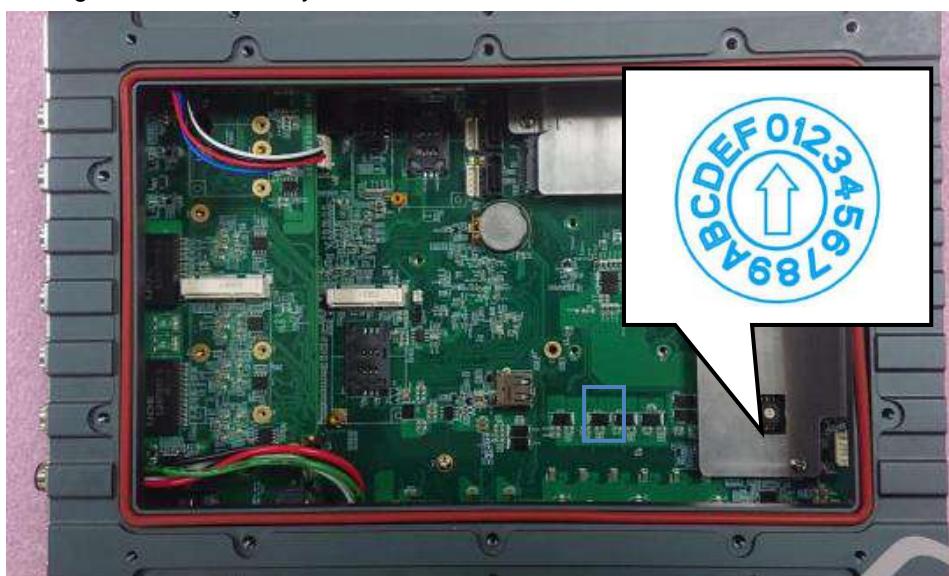

5. Operation Modes of Ignition Control

You can use the rotary switch to configure the operation mode. The system offers 16 (0~15) operation modes with different power-on/power-off delay configurations.

Mode 0

Mode 0 is the ATX mode without power-on and power-off delay. Users can only use the power button on the front panel to turn on or turn off the system.

Mode	Power-on Delay	Power-off Delay	Hard-off Timeout
0	N/A	N/A	N/A

Mode 1

Mode 1 is AT mode without power-on and power-off delay. The system automatically turns on when DC power is applied. A retry mechanism is designed to repeat the power-on cycle if the system fails to boot up.

Mode	Power-on Delay	Power-off Delay	Hard-off Timeout
1	N/A	N/A	N/A

Mode 2

Mode 2 is designed to have a very minor power on/ off delay of 160ms for applications that require the system to start-up almost at the same as the rest of the equipment it is working in collaboration with.

Mode	Power-on Delay	Power-off Delay	Hard-off Timeout
2	160ms	160ms	10 minutes

Mode 3 ~ Mode 12

Mode 3 ~ Mode 12 have various power-on delays and power-off delays. Each mode supports a hard-off timeout of 10 minutes.

Mode	Power-on Delay	Power-off Delay	Hard-off Timeout
3	10 seconds	10 seconds	10 minutes
4	10 seconds	1 minute	10 minutes
5	10 seconds	5 minutes	10 minutes
6	30 seconds	1 minute	10 minutes
7	30 seconds	5 minutes	10 minutes
8	30 seconds	10 minutes	10 minutes
9	3 minutes	1 minute	10 minutes
10 (A)	3 minutes	10 minutes	10 minutes
11 (B)	3 minutes	30 minutes	10 minutes
12 (C)	10 minutes	30 minutes	10 minutes

Mode 13 (D) / Mode 14 (E)

Mode 13 and Mode 14 are ignition power control modes with very long power-off delays. Both modes support the feature of “smart off-delay”, which automatically

detect system status during power-off delay duration and cut off system power if the system is off before the power-off delay expires.

Mode	Power-on Delay	Power-off Delay	Hard-off Timeout
13 (D)	30 seconds	2 hours	10 minutes
14 (E)	3 minutes	2 hours	10 minutes

Mode 15 (F)

Reserved

6. Once you have configured the ignition rotary switch, you are ready to re-secure the backplate.
7. Before doing so, please make sure the O-ring is properly seated in the groove around the chassis edges.
8. Please attached the backplate, and secure the plate using the original ten screws in the following incremental order, and at the torque force specified.



NOTE

The recommended torque range for screws is 6.3 to 7.7 kgf-cm



O-ring seated properly in the groove

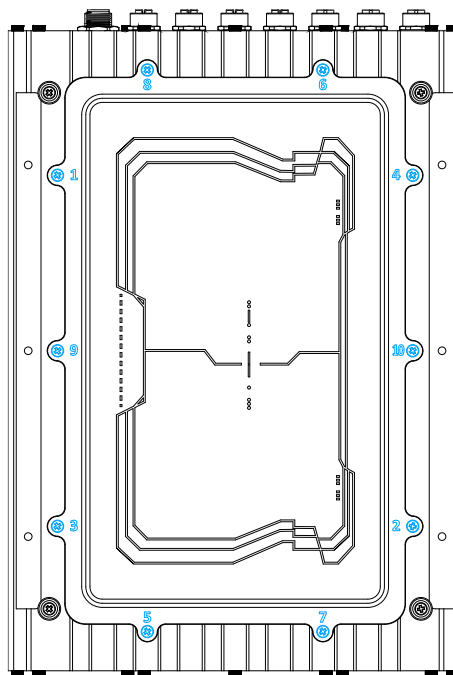



Attach the backplate, incremental screw order, and at a specified torque range (6.3 to 7.7 kgf-cm)

5 System Configuration

5.1 BIOS Settings

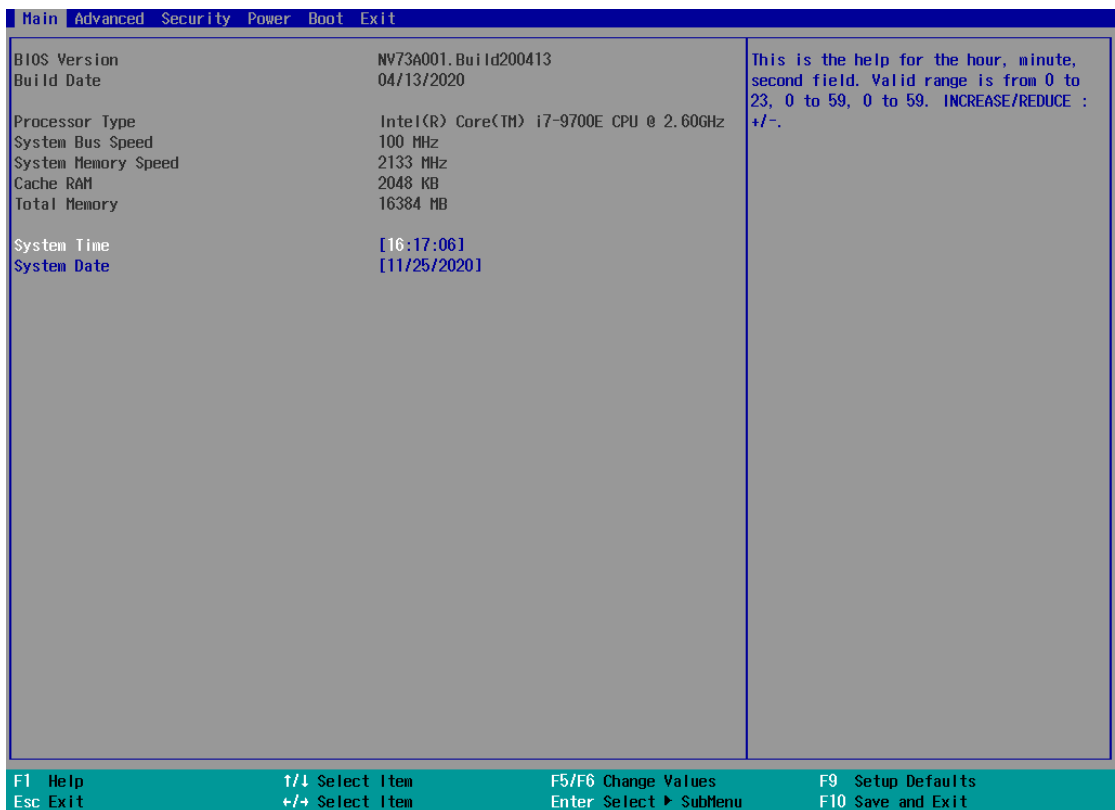
The system is shipped with factory-default BIOS settings meticulously programmed for optimum performance and compatibility. In this section, we'll illustrate some of BIOS settings you may need to modify. Please always make sure you understand the effect of change before you proceed with any modification. If you are unsure of the function you are changing, it is recommended to change one setting at a time to see its effect(s).



 **NOTE**

Not all BIOS settings will be discussed in this section. If a particular setting/ function you are after requires specific BIOS settings but is not discussed in this section, please contact Neousys Technical Support staff.

5.1.1 COM Port Configuration

The system's [COM1/COM2](#) ports support RS-232 (full-duplex) mode. Another option in BIOS called “*Slew Rate*” defines how sharp the rising/falling edge is for the output signal of COM1.

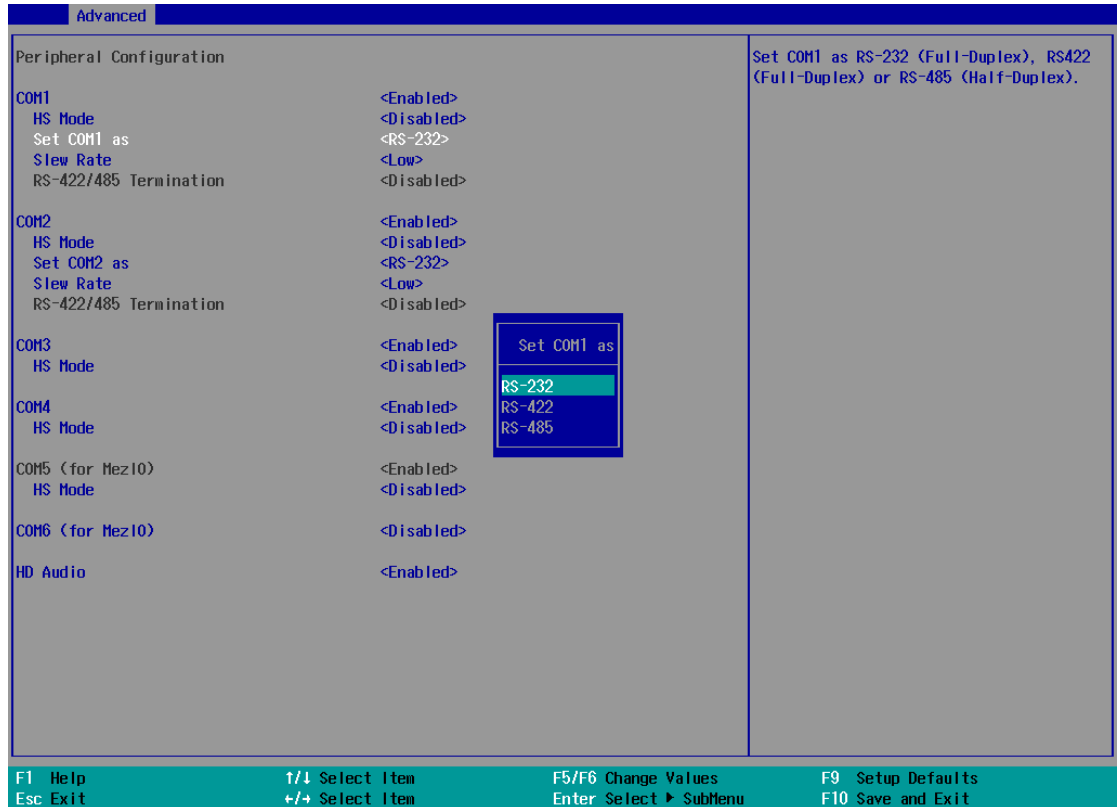

To set COM port operating mode:

1. Press **F2** when the system boots up to enter the BIOS setup utility.
2. Go to **[Advanced] → [Peripheral Configuration]**.
3. Set the **[Set COM1 Mode as]** option to the desired mode.
4. Once set, press **F10** to save setting and exit.

5.1.2 COM Port High Speed Mode

The high speed mode of each COM port effectively allows for the port's baud rate generator to operate at 8x the speed with an effective baud rate of 921,600 bps (115,200 x 8). Please refer to the following instructions on how to enable the high speed mode for your COM port (COM1 used as an example).

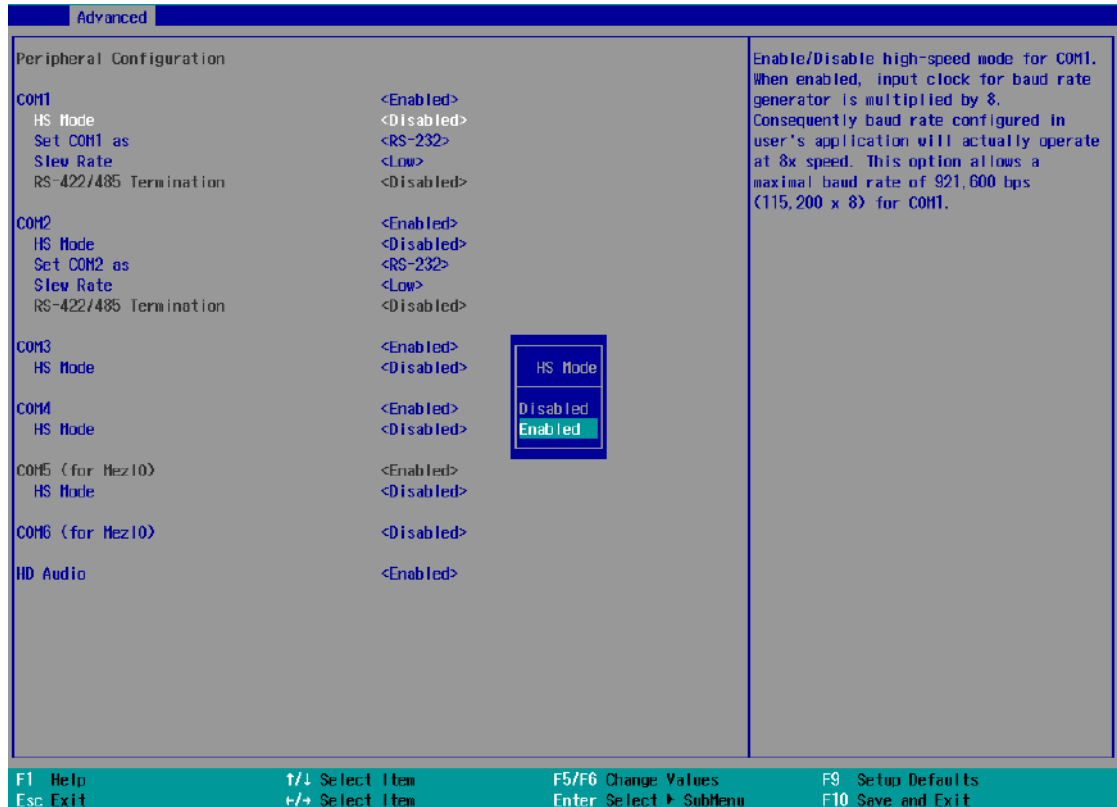

To set COM port high speed mode:

1. Press **F2** when the system boots up to enter the BIOS setup utility.
2. Go to **[Advanced] > [Peripheral Configuration]**.
3. Enable or set the **[Set COM1 Mode as]** option to the desired mode.
4. Highlight **[HS Mode]** and press ENTER to bring up options, highlight **[Enable]** and press ENTER.
5. Once set, press **F10** to save setting and exit.

5.1.3 Delay for PEG Initialization

This setting offers delay in milliseconds for PEG port initialization and PCI enumeration. By increasing the delay value, it may eliminate compatibility issue(s) with some PCIe add-on cards.

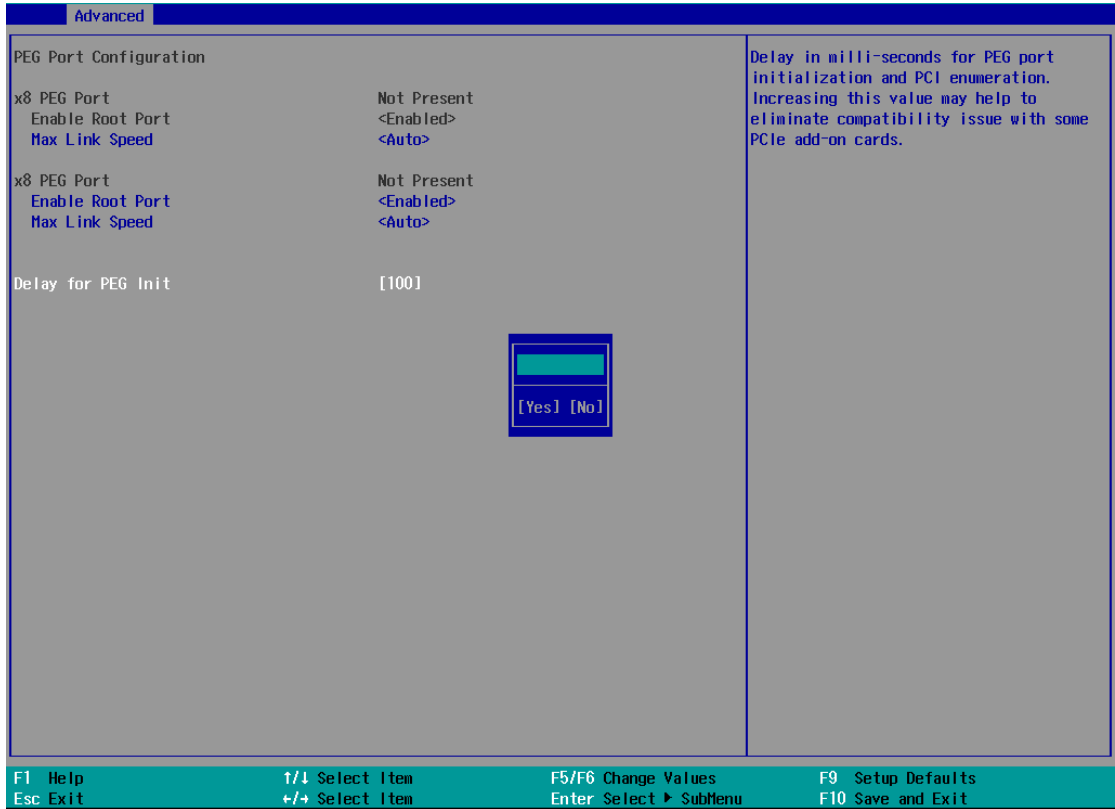

To set PEG delay in milliseconds:

1. When system boots up, press F2 to enter BIOS setup utility.
2. Go to **[Advanced] > [System Agent (SA) Configuration] > [PEG Port Configuration] > [Delay for PEG Init]** and press ENTER.
3. A small window appears and you may enter a maximum delay value of up to 30,000ms.
4. When done, press F10 to “Exit Saving Changes”

5.1.4 SATA Configuration

The SATA controller of your system supports two (2) operating modes: **AHCI** and **Intel RST Premium With Intel Optane System Acceleration mode**. The **AHCI** mode, which exposes SATA's advanced capabilities such as hot swapping and native command queuing, is supported in several later version of operating systems. The **Intel RST Premium With Intel Optane System Acceleration** mode allows the user to greatly accelerate SATA hard drive read/ write speeds by installing an Optane memory into the M.2 slot. Please refer to the section “**Intel RST Premium With Intel Optane System Acceleration**” for details.

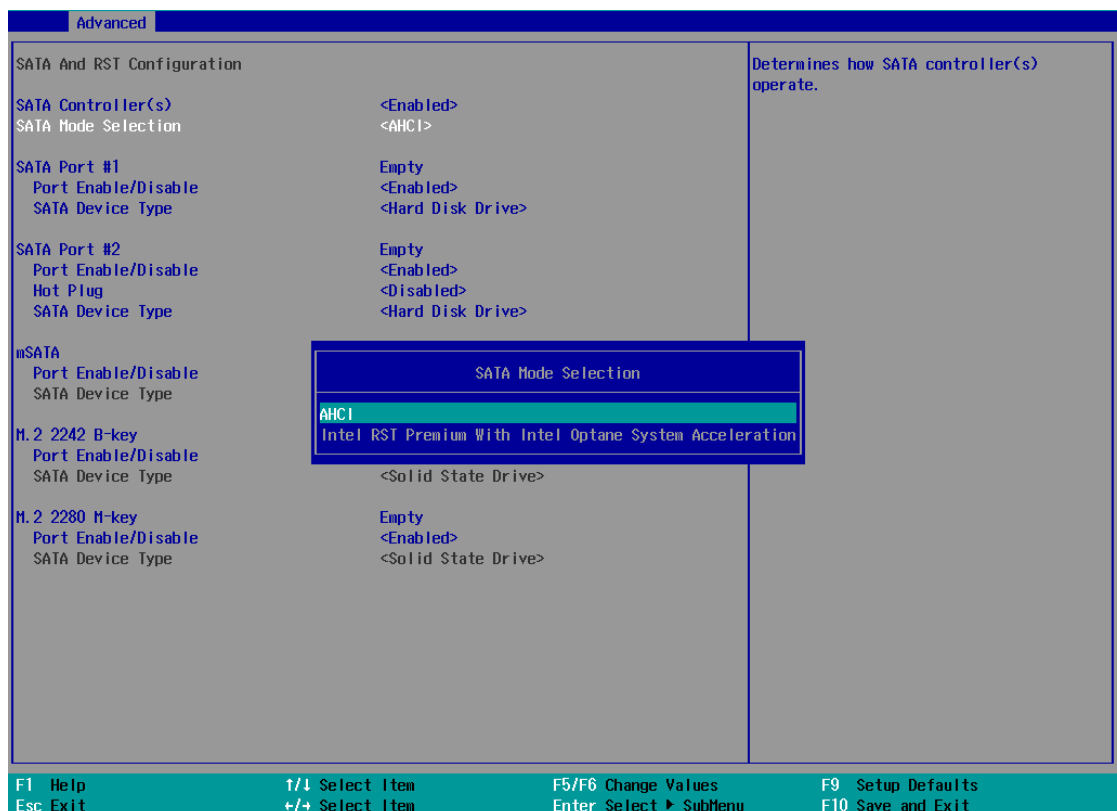

Recommended SATA controller mode settings:

- If you're using Windows 10, or Linux with kernel 4.15.18 or later, you can select **AHCI** mode for better performance.
- If you are looking for faster hard drive read/ write performance, please install an SSD (M.2, mPCIe, SATA) or install an Intel® Optane™ memory for hard drive acceleration.

To set SATA controller mode:

1. When system boots up, press F2 to enter BIOS setup utility.
2. Go to **[Advanced] > [SATA Configuration]**.
3. Highlight the SATA, mSATA or M.2 port you wish to set and press ENTER to bring up setting options. Scroll to and highlight the setting you wish to set and press ENTER.

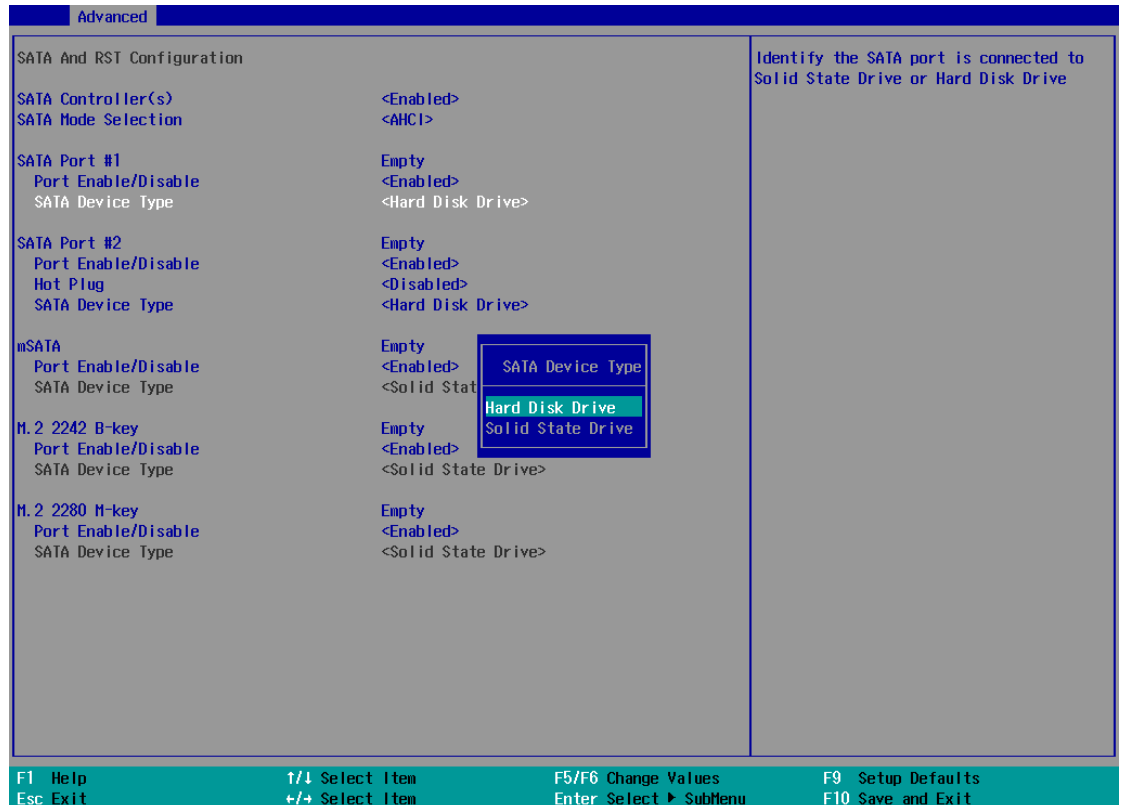

4. Repeat step 3 to set other SATA ports.
5. Press F10 to “Exit Saving Changes”.

5.1.5 TPM Availability

Trusted Platform Module (TPM) is a hardware-based cryptoprocessor to secure hardware by integrating cryptographic keys into devices. The system is designed with on-board TPM 2.0 module. As TPM 2.0 requires 64-bit Windows 10 with UEFI boot mode, it is enabled in BIOS by default.

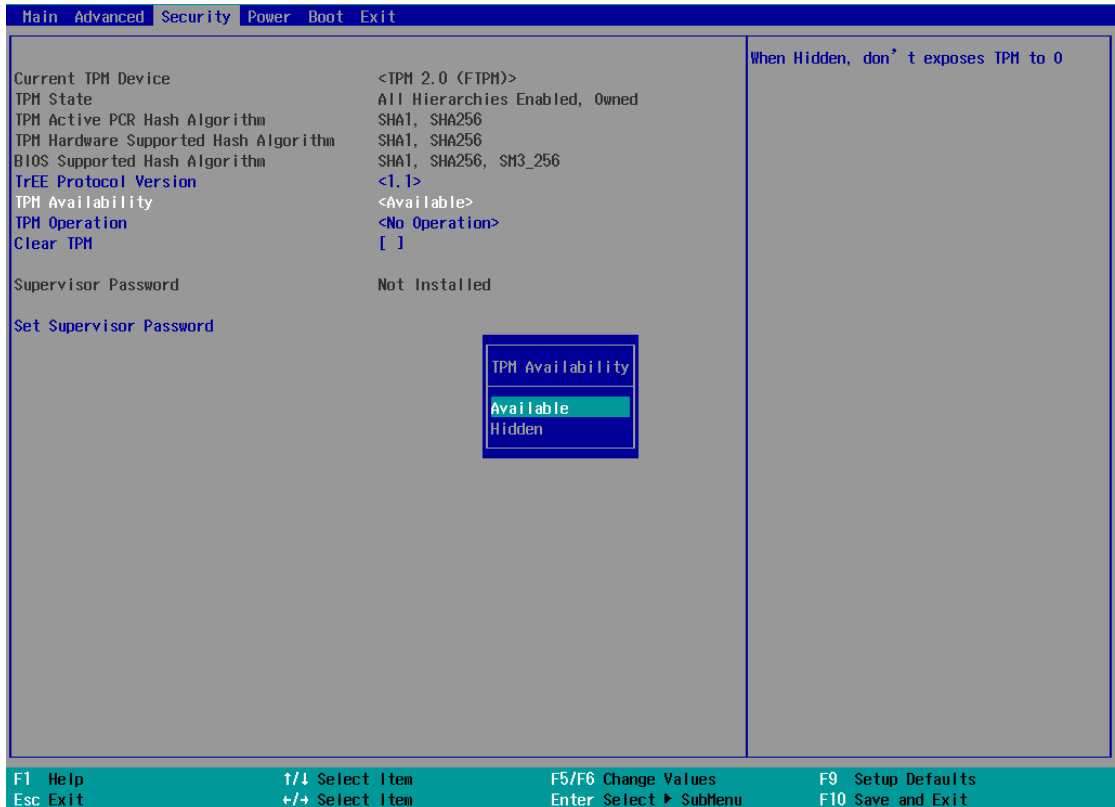

To enable TPM availability:

1. When system boots up, press F2 to enter BIOS setup utility.
2. Go to **[Security] > [TPM Availability]**, press Enter to bring up Options, Available/Hidden.
3. Highlight your selection, press Enter and press F10 to "Exit Saving Changes".

5.1.6 Auto Wake on S5

When the system is set to operate in S5 state, the user can specify a time to turn on the system, daily or monthly.



Value	Option	Description
Auto Wake on S5	Disabled	The system does not turn on when operating in state S5.
	By Every Day	The system turns on each day when operating in state S5. Specify the time of day.
	By Day of Month	The system turns on each month when operating in state S5. Specify the day and time.

Highlight your selection, press ENTER and press F10 to “Exit Saving Changes”.

5.1.7 Power On After Power Failure Option

This option defines the behavior of system series when DC power is supplied.

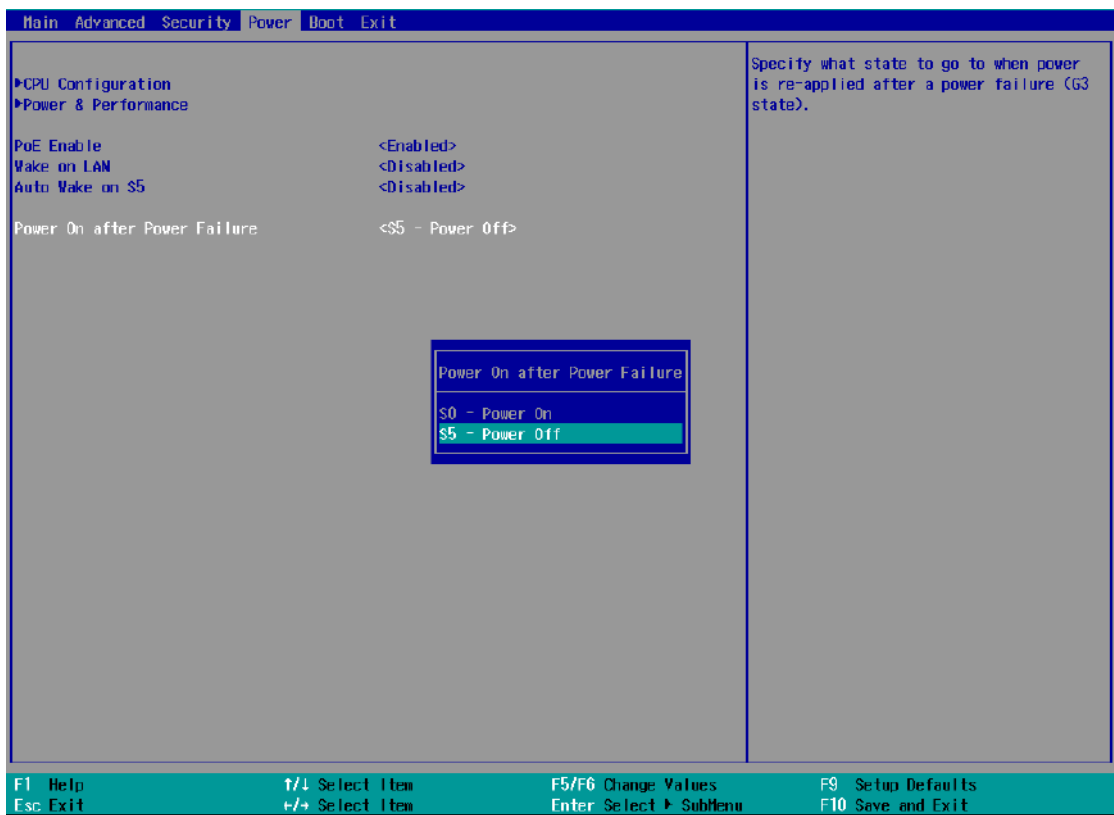

Value	Description
S0 – Power On	System is powered on when DC power is supplied.
S5 – Power Off	System is kept in off state when DC power is supplied.

To set “Power On after Power Failure” option:

1. When system boots up, press F2 to enter BIOS setup utility.
2. Go to **[Power] > [Power On after Power Failure]**.
3. Scroll down to highlight **[Power On after Power Failure]**, press ENTER to bring up setting options, S0 – Power On or S5 – Power Off, and press ENTER to select the setting.
4. Press F10 to “Exit Saving Changes”.

5.1.8 Power & Performance (CPU SKU Power Configuration)

The system supports various 8th Gen Coffee Lake LGA1151 CPUs. A unique feature, “**SKU Power Config**” is implemented in BIOS to allow users to specify user-defined SKU power limit. Although the system is designed to have best thermal performance with CPUs of 35W TDP, you can install a 65W CPU and limit its SKU power (to 35W) to obtain more computing power. This feature gives you the flexibility of CPU selection and great balance between computing power and operating temperature range.



To configure the CPU SKU power limit:

1. When the system boots up, press F2 to enter BIOS setup utility.
2. Go to **[Power]** → **[Power & Performance]**.
3. Select a proper value of SKU power limit for **[SKU Power Config]** option.
4. Press F10 to "Exit Saving Changes".

5.1.9 Wake on LAN Option

Wake-on-LAN (WOL) is a mechanism which allows you to turn on your System series via Ethernet connection. To utilize Wake-on-LAN function, you have to enable this option first in BIOS settings. Please refer "[Powering On Using Wake-on-LAN](#)" to set up the system.



To enable/disable "Wake on LAN" option:

1. When system boots up, press F2 to enter BIOS setup utility.
2. Go to **[Power] > [Wake on LAN]**.
3. Press Enter to bring up setting options, scroll to the setting you desire and press Enter to set.
4. Press F10 to "Exit Saving Changes."

5.1.10 Boot Menu

The Boot menu in BIOS allows you to specify the system’s boot characteristics by setting bootable device components (boot media) and method. Or, you may press F12 upon system start up and select a device you wish boot from.





Value	Option	Description
Boot Type	Dual Boot Type	Both legacy and EFI boot media listed are approved as boot media.
	Legacy Boot Type	Only legacy boot media listed are approved as boot media.
	UEFI Boot Type	Only UEFI boot media listed are approved as boot media.
Quick Boot	Enabled	The system starts up faster because BIOS skips various hardware function tests
	Disabled	The system starts up slower because BIOS goes through various hardware functions tests
Network Stack	Enabled	The system is available for network access using UEFI.
	Disabled	The system is not available for network access using UEFI.
PXE Boot	Disabled	Only UEFI Network Stack is supported: Preboot

capability		eXecution Environment (PXE) is not supported
	Enabled	By enabling the PXE boot, one can choose to boot via I219 Only/ I210 Only or All NICs .
Add Boot Options	First	Newly detected boot media are placed at the top of the boot order.
	Last	Newly detected boot media are placed at the bottom of the boot order.
ACPI Selection	1.0B/ 3.0/ 4.0/ 5.0/ 6.0	Advanced Configuration and Power Interface allows the operating system to control system power management
USB Boot	Enabled	Allow boot from bootable USB devices.
	Disabled	Does not allow boot from bootable USB devices
EFI Device First	Enabled	Set to boot bootable EFI media first.
	Disabled	Will not boot bootable EFI media first.
Timeout	1, 2, 3, etc (in seconds)	Boot delay time in seconds to give the user time to activate the hotkey to access the BIOS
Automatic Failover	Enabled	Automatically checks for the next bootable device when the set default device fails.
	Disabled	Will only boot from the designated device.
WDT for booting	Disabled, 1, 3, 5, 10 (minutes)	WDT ensures a successful system boot by specifying a timeout value

5.1.11 Boot Type (Legacy/ UEFI)

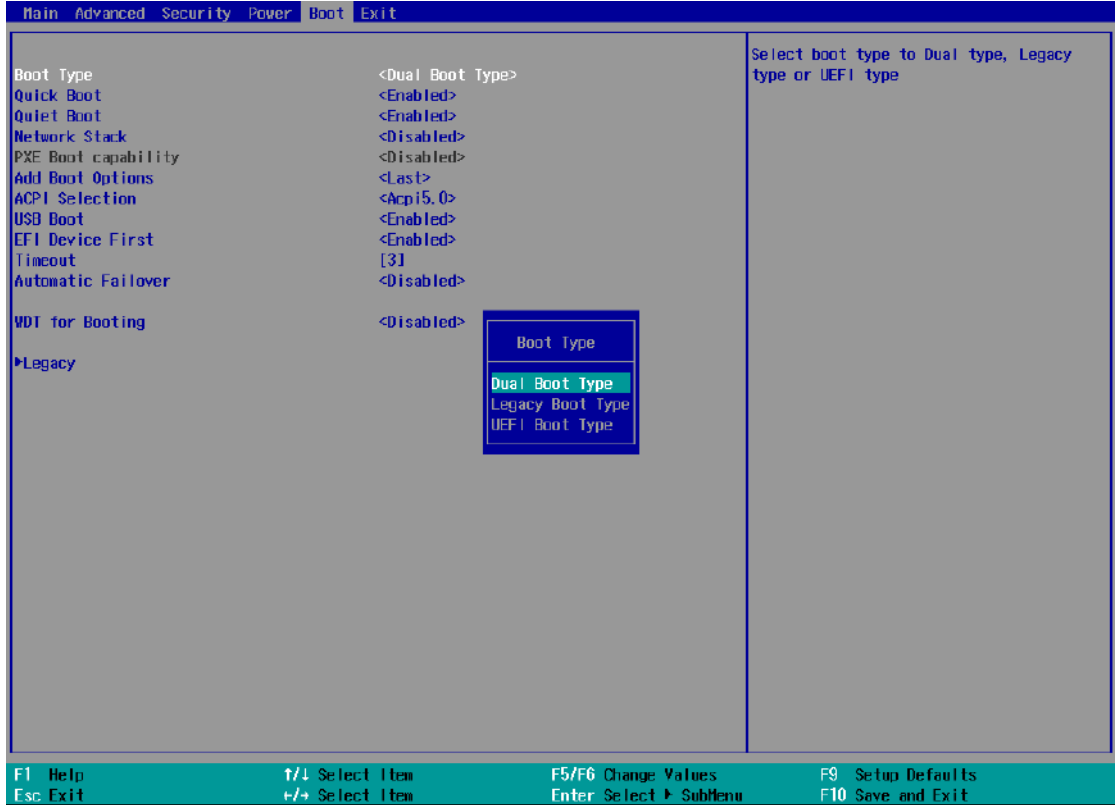
The system supports both Legacy and Unified Extensible Firmware Interface (UEFI) boot modes. UEFI is a specification proposed by Intel to define a software interface between operating system and platform firmware. Most modern operating systems, such as Windows 7/ 8/ 10 and Linux support both Legacy and UEFI boot modes. The Legacy boot mode uses MBR partition for disk and VBIOS for video initialization, the UEFI boot mode uses GPT partition which supports greater than 2TB partition size and GOP driver for faster video initialization.



 **NOTE**

If you choose Legacy mode, you will not be able to create disk partitions greater than 2TB or use TPM 2.0 function.

To configure Boot Type:

1. When system boots up, press F2 to enter BIOS setup utility.
2. Go to **[Boot]>[Boot Type]**, press Enter to bring up options, Dual Boot (Legacy+UEFI), Legacy Boot Type, UEFI Boot Type.
3. Highlight your selection and press Enter.
4. Press F10 to “Exit Saving Changes”.

5.1.12 Boot Option for Newly Added Device

The “Add Boot Options” allow you to determine whether a newly added device (eg. USB flash disk) is to boot as the first device to boot or the last in the boot sequence.

To set the newly-installed boot device as the first or last boot device:

1. Press **F2** when the system boots up to enter the BIOS setup utility.
2. Go to **[Boot] > [Add Boot Options]** menu.
3. Select **[First]** or **[Last]** for your newly-added boot device and press ENTER.

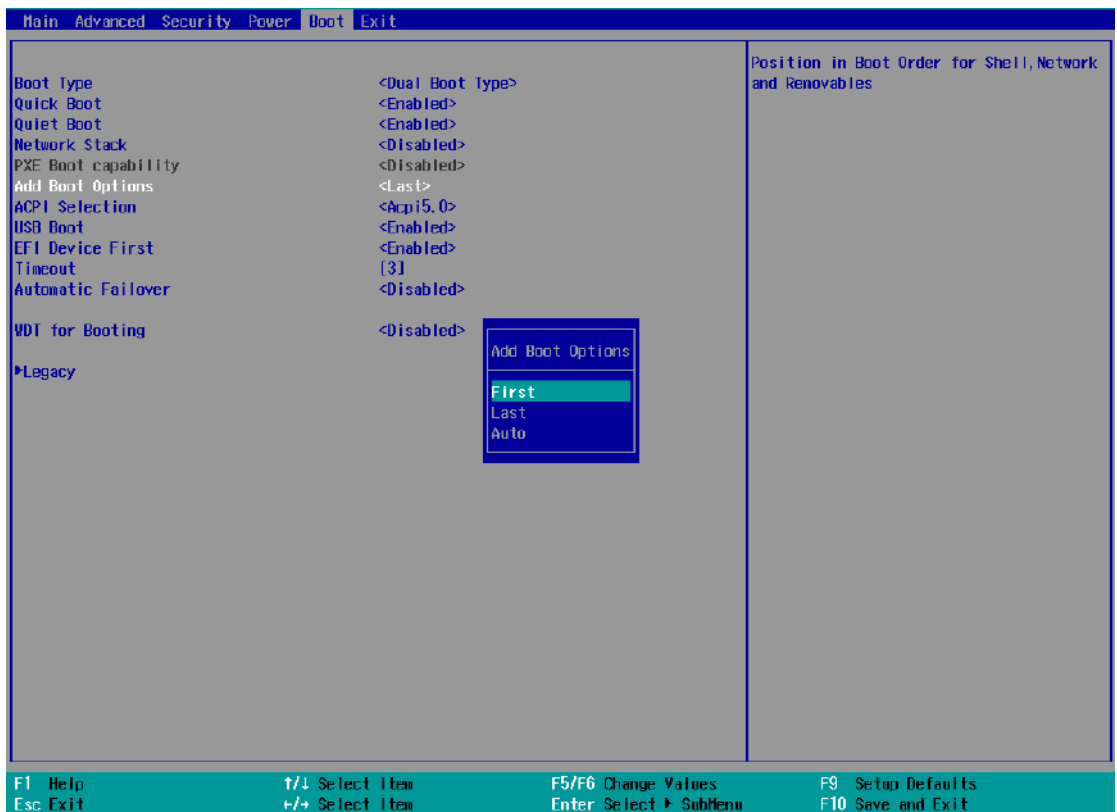

4. Highlight your selection and press Enter, press F10 to “Exist Saving Changes”.

5.1.13 Watchdog Timer for Booting

The watchdog timer secures the boot process by means of a timer. Once the timer expires, a reset command is issued to initiate another booting process. There are two options in BIOS menu, “*Automatically after POST*” and “*Manually after Entering OS*”. When “*Automatically after POST*” is selected, the BIOS automatically stops the watchdog timer after POST (Power-On Self Test) OK. When “*Manually after Entering OS*” is selected, the user must stop the watchdog timer once booted into the OS. This guarantees the system can always boot into the OS, otherwise another booting process will be initiated. For information about programming watchdog timer, please refer to [Watchdog Timer & Isolated DIO](#).

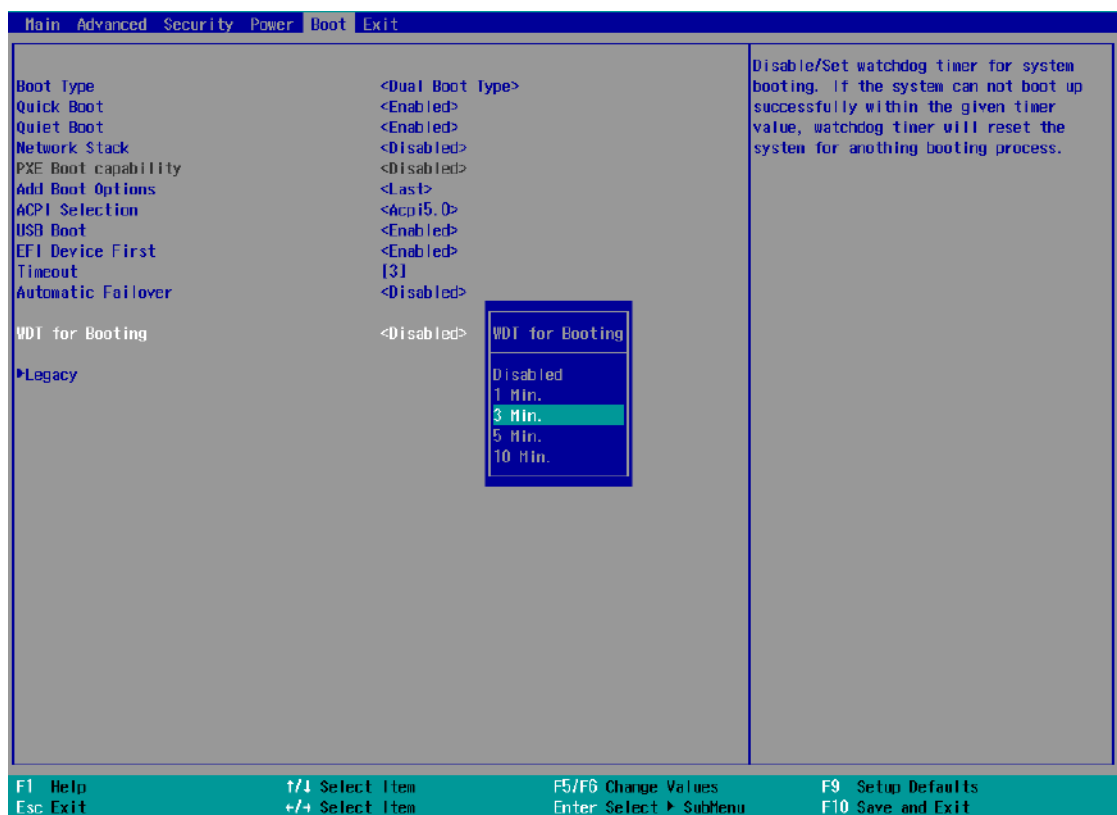

To set the watchdog timer for boot in BIOS:

1. When system boots up, press F2 to enter BIOS setup utility.
2. Go to **[Boot]** menu.
3. Disable or select timeout value for **[WDT for Booting]** option.
4. Once you give a timeout value, the **[WDT Stop Option]** option appears. You can select “*Automatically after POST*” or “*Manually after Entering OS*”.
5. Press F10 to “Exit Saving Changes”.

5.1.14 Selecting Legacy/ UEFI Boot Device

When you wish to set a designated boot device, you may set it as the first device to boot in Legacy or UEFI Boot Device setting. Or if you wish to manually select a boot device, you may do so by pressing F12 when the system boots up.



To set boot order for devices in UEFI Boot Device:

1. When system boots up, press F2 to enter BIOS setup utility
2. Go to **[Boot] > [UEFI Boot Device]**
3. Highlight the device you wish to make boot order changes to and press F5/ F6 or +/- to change device boot order.

To select boot order for devices in Legacy Boot Device:

1. When system boots up, press F2 to enter BIOS setup utility
2. Go to **[Boot] > [Legacy Boot Device]**, you can choose the type of device to boot list by selecting “By Device” or “By Device Type”.
3. Highlight the device or device category you wish to make boot order changes to and press F5/ F6 or +/- to change device boot order.

5.2 AMT Configuration

Intel® AMT (Active Management Technology) is a hardware-based technology for remotely managing target PCs via Ethernet connection. The system supports AMT function via its Ethernet port implemented with Intel I219-LM. Prior to using AMT to remotely control the system, you need to configure AMT password and network settings.

1. Connected Ethernet cable to I219-LM port (indicated in green).

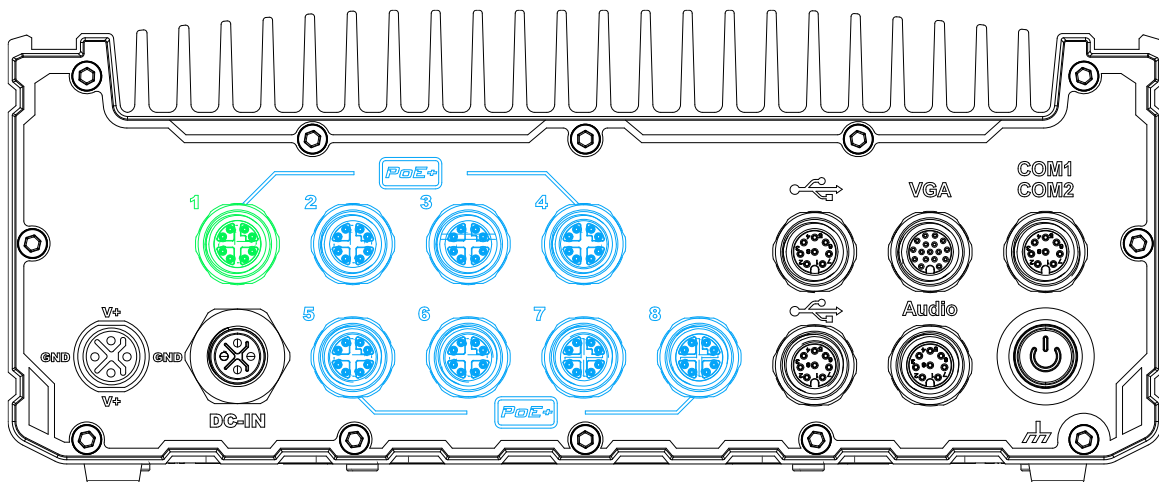

2. When the system boots up, press F10 to enter the MEBx configuration menu.

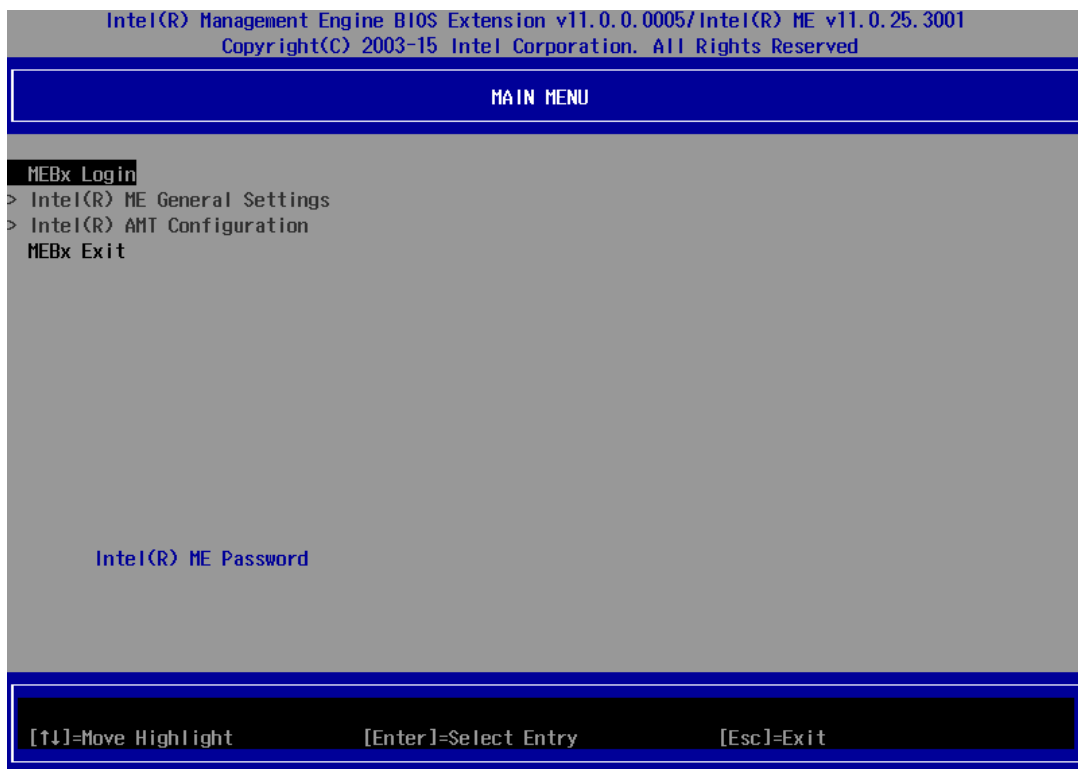

3. Highlight MEBx Login and press Enter, a prompt will appear asking for password. The default password is "admin". For further MEBx configuration details, please refer to [Intel® MEBX User Guide](#).

5.3 RAID Volume Configuration

To set up a RAID 0 or 1 volume in Legacy or UEFI mode, you need to have at least two hard drives or SSDs installed. The system supports RAID configurations in RAID 0 (striping) or RAID 1 (mirror) mode. Users can select the configuration that best suit their needs with RAID 0 (striping) mode offering better hard drive read/ write performances while RAID 1 (mirror) offers better data security.



WARNING

Please back up hard drive data before you create or modify RAID volume(s) as the process may cause irreversible data deletion. When creating a RAID volume, it is also recommended to use hard drives from the same batch (same brand, model, capacity, rpm rate, etc.) to avoid performance or capacity allocation issues.

5.3.1 Legacy Mode RAID Configuration

To set up RAID configuration, you need to pre-configure the SATA mode setting in the BIOS. Please refer to the following steps:

1. When system boots up, press **F2** to enter BIOS setup utility.
2. Go to **[Advanced] > [SATA And RST Configuration] > [SATA Mode Selection]** > highlight **[Intel RST Premium With Intel Optane System Acceleration]** and press ENTER.



- Go to [Boot] > highlight [**Legacy Boot Type**] and press ENTER to set boot type.

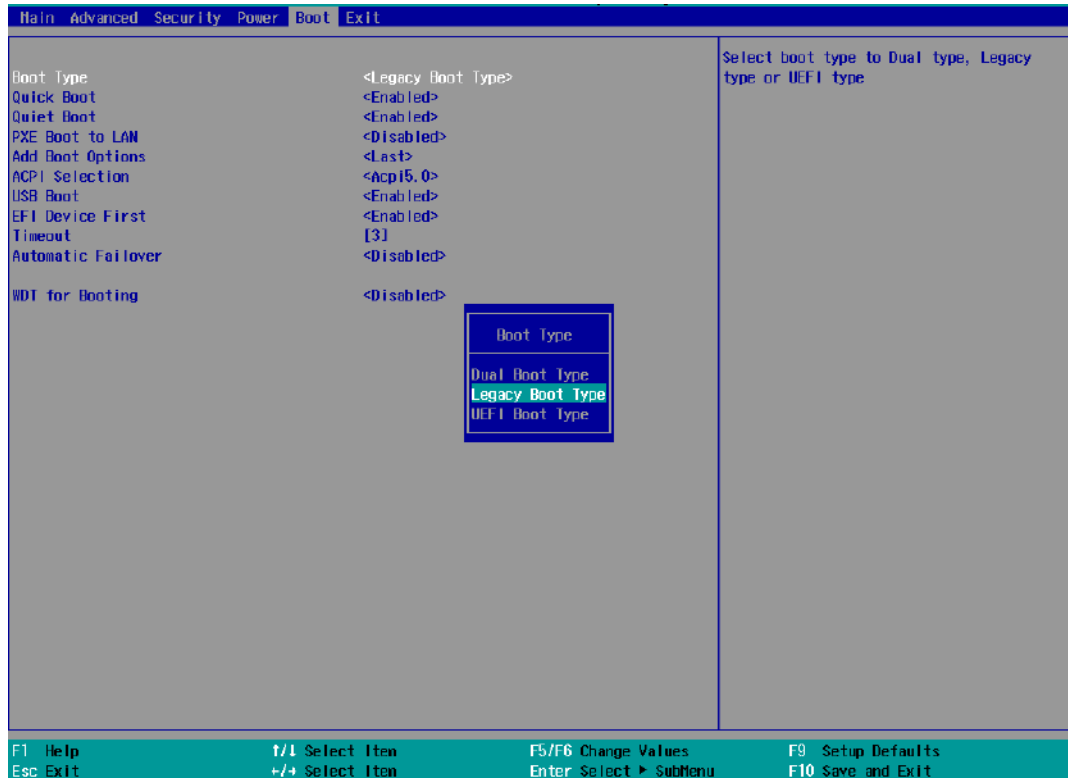

- Press F10 to "Exit Saving Changes" and reboot the system.
- When the system reboots, press [**Ctrl + I**] to enter the RAID configuration utility.
- Once you're in the Configuration Utility, highlight [**Create RAID Volume**] and press ENTER.



- The following screen allows you to enter the **Name** of the RAID volume you wish to create. Enter a name and press ENTER to access the **RAID Level** setting.

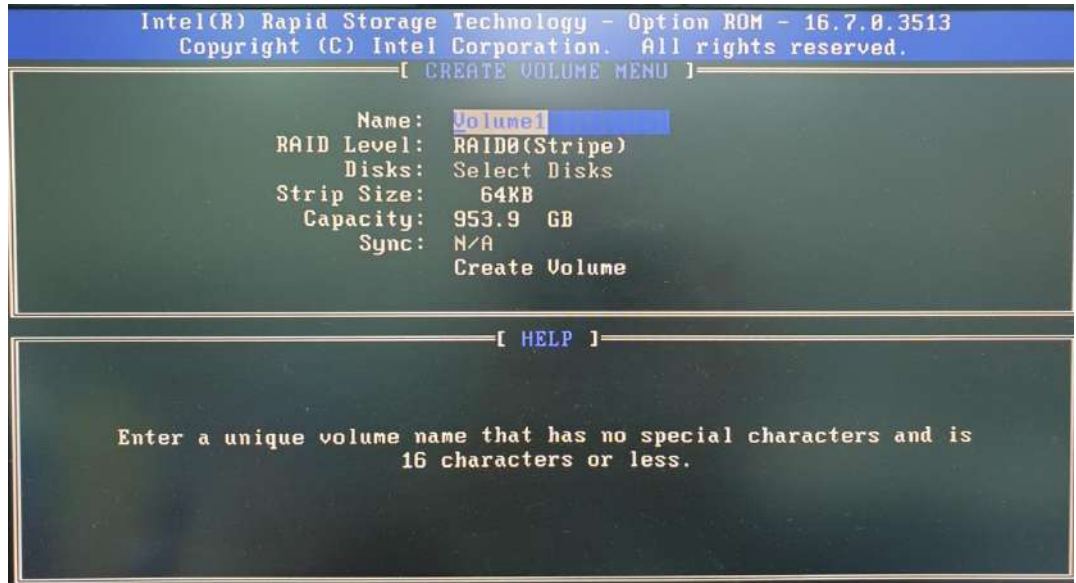

- For **RAID Level**, use the up and down arrow key to select between **RAID0 (Stripe)** or **RAID1 (Mirror)** settings. Select a RAID mode and press ENTER to access **Stripe Size** setting (not applicable to Mirror mode).



- For **Stripe Size**, use the up and down arrow key to select between 4KB, 8KB, 16KB, 32KB, 64KB, 128KB for your RAID volume stripe size and press ENTER to access the **Capacity** setting.

*RAID1(Mirror) does not offer Stripe Size options.

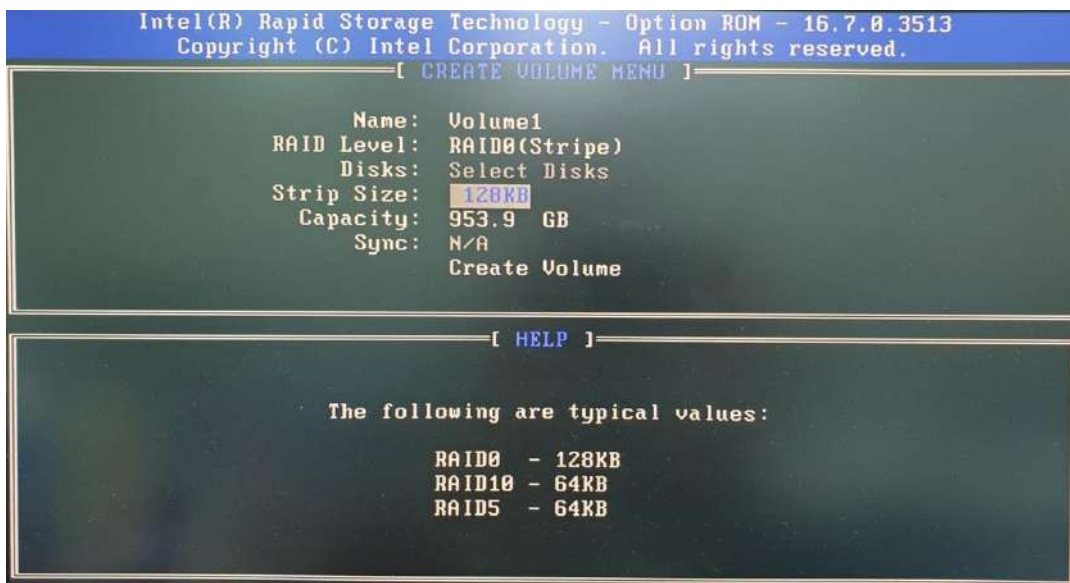

- You may enter the RAID volume capacity you wish to create at this step and press the Enter key to complete your RAID settings. By default, the maximum capacity will be applied. Once you have entered a capacity, press ENTER to confirm.

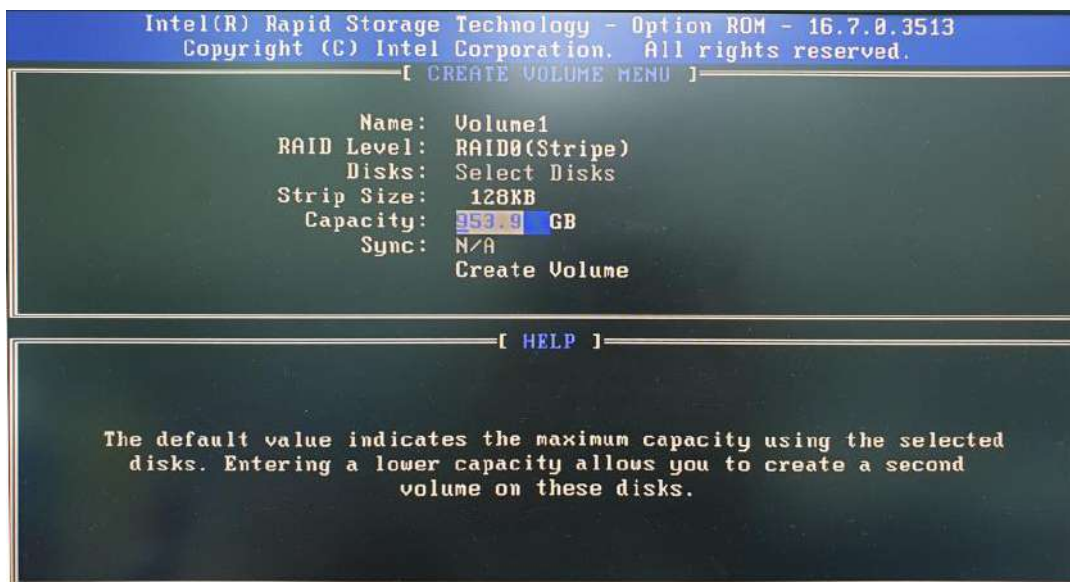

11. Reviewed your settings and if you wish to change any setting(s), you will need to press [ESC] and start again from **Step 5**. If all settings are correct and you wish to continue, with **“Create Volume”** highlighted, press ENTER to begin creating the RAID volume.

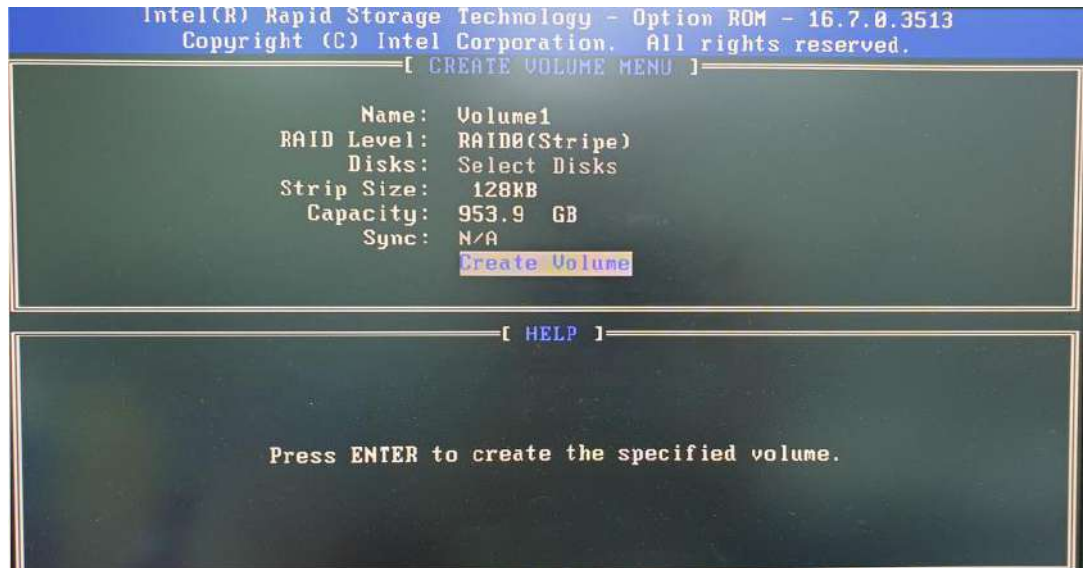

12. A data deletion warning will appear, enter “Y” to continue and “N” to stop the volume creation process.

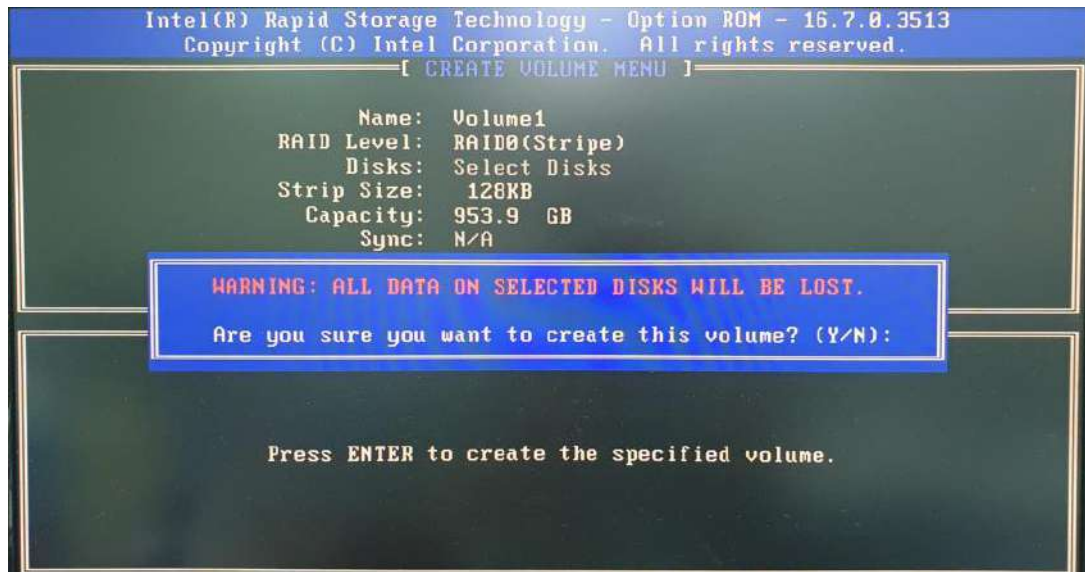

13. Once the RAID volume has been created, the configuration utility will bring you back to the main screen showing the RAID volume and their member disks.

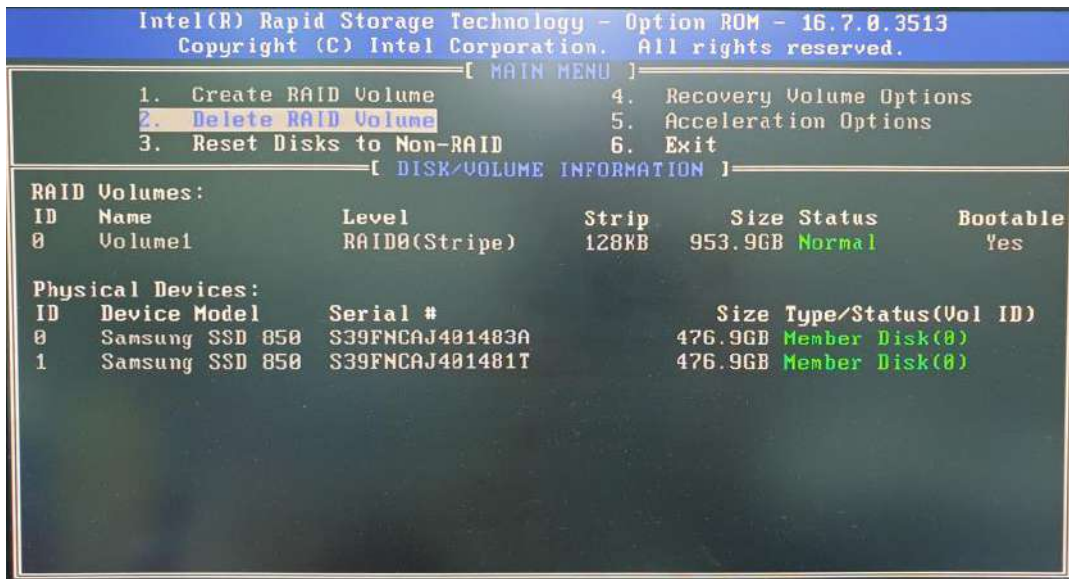

14. The above process was to create a RAID-0 volume. If you wish to create a RAID-1 volume, please perform steps 5 to 13 in this section and select RAID-1 during step 8.

5.3.2 UEFI Mode RAID Configuration

To enable RAID functionality in UEFI mode:

1. When system boots up, press F2 to enter BIOS setup utility.
2. Go to **[Advanced] > [SATA And RST Configuration] > [SATA Mode Selection]** > highlight **[Intel RST Premium With Intel Optane System Acceleration]** and press ENTER.

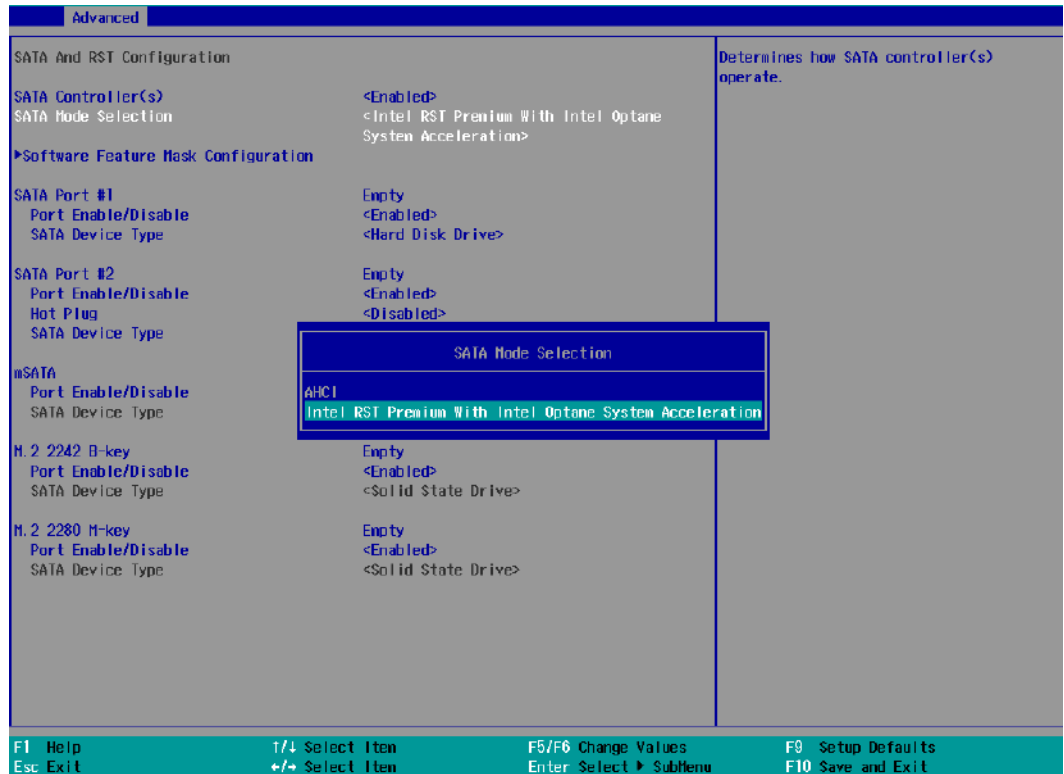

- Go to **[Boot]**, highlight **[UEFI Boot Type]** and press ENTER to set boot type.

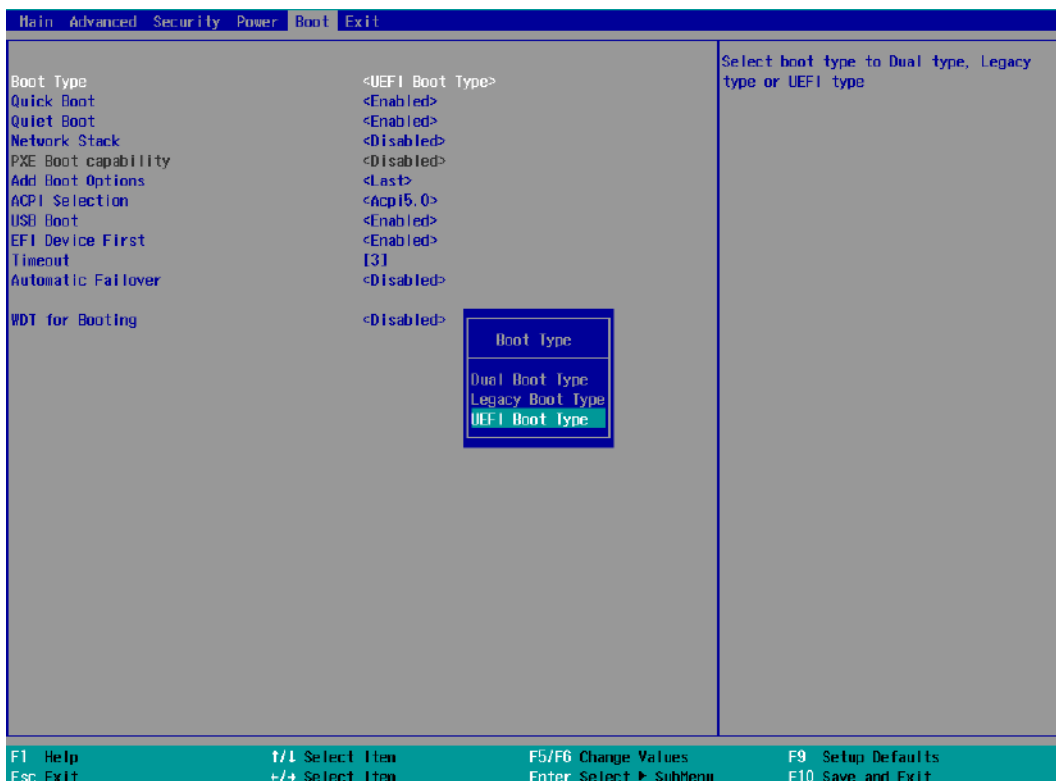

- Press F10 to “Exit Saving Changes” and reboot the system.
- When the system reboots, press **[F3]** to enter the Configuration Utility.
- Once you’re in the Configuration Utility, highlight **[Intel® Rapid Storage Technology]** and press ENTER.



7. The following screen shows Non-RAID physical disks and the option “**Create RAID Volume**”. Highlight “**Create RAID Volume**” and press ENTER to begin creating your RAID volume.

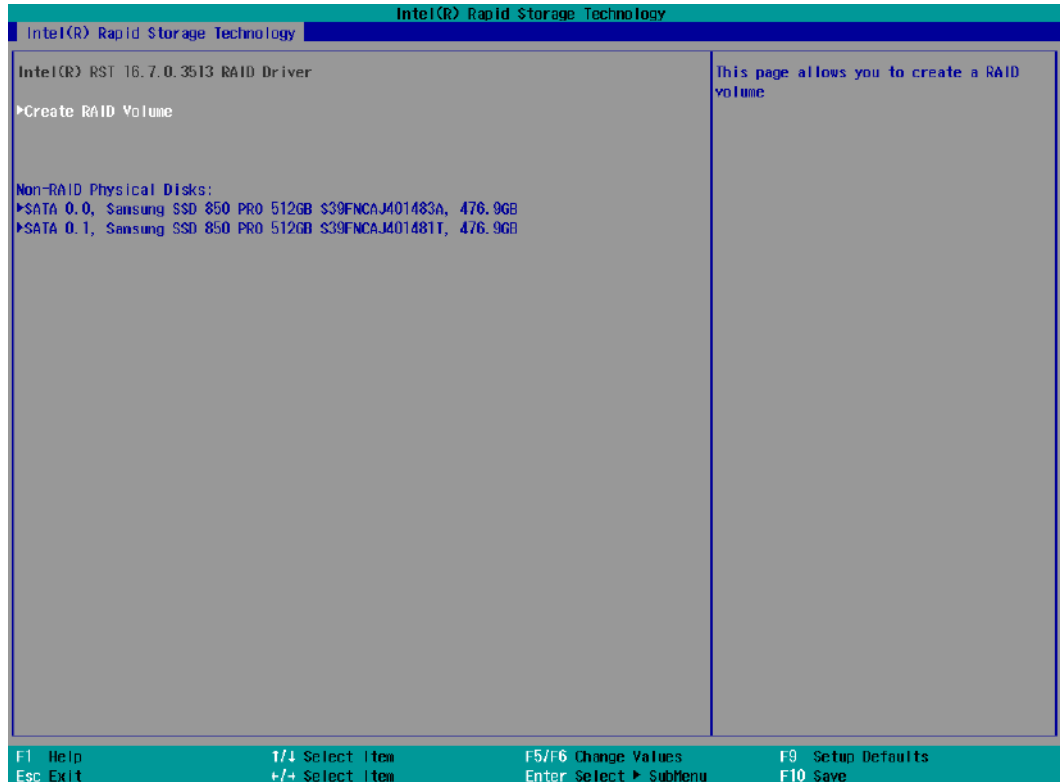

8. The Name option allows you to name your RAID volume. Press ENTER when ready to go to the next option.



9. The RAID Level option allows you to select RAID-0 (striping) or RAID-1 (mirror) for your RAID volume. Press ENTER when ready.

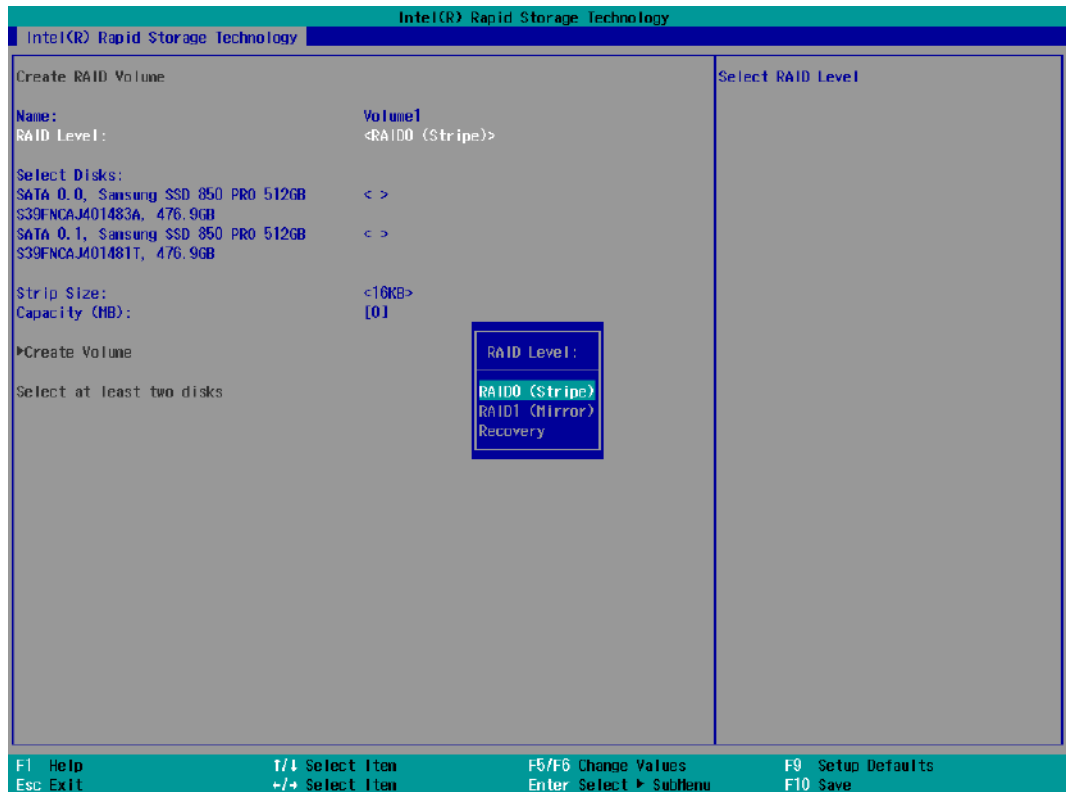

10. The Select Disks option allows you to select disk drives for your RAID volume. Highlight a drive and press ENTER, use up/ down arrow keys to highlight "x" and press ENTER to confirm the selection. A minimum of two disk drives must be selected for RAID-0 or RAID-1 configuration. Press ENTER when ready.

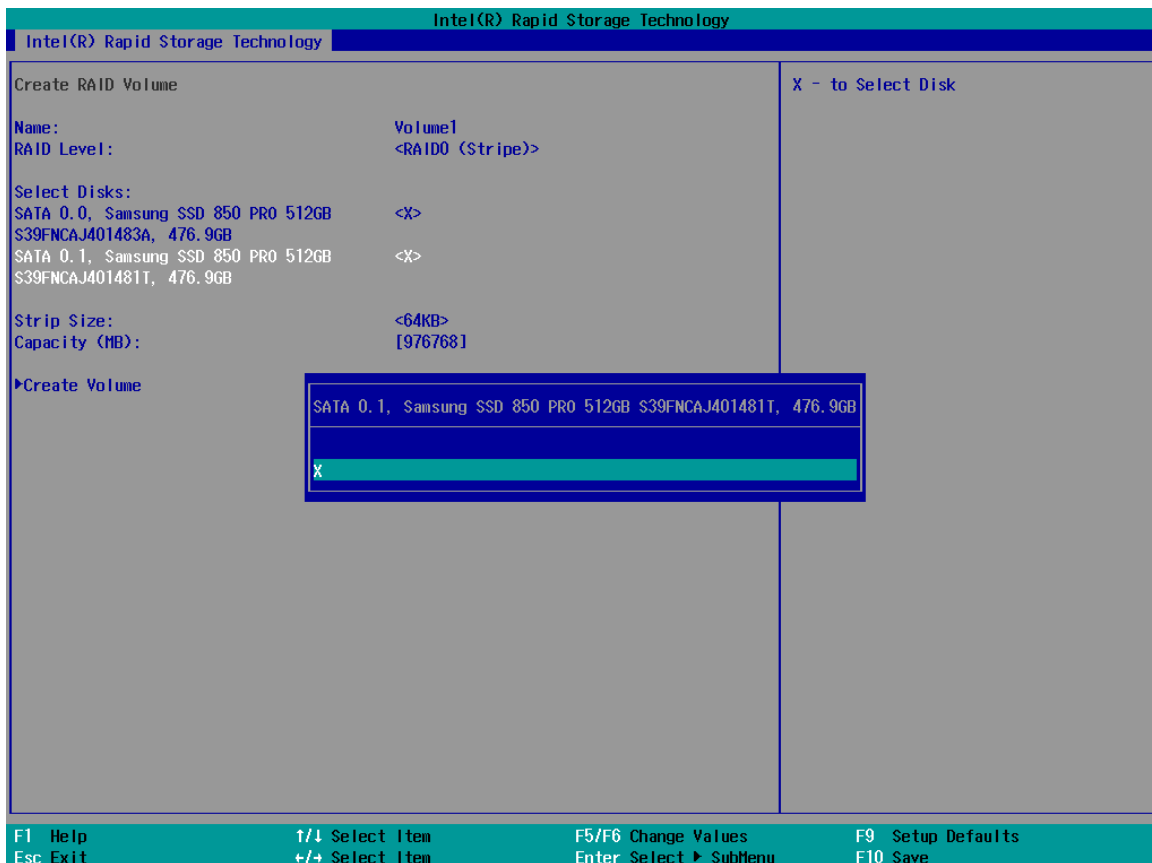

11. The Stripe Size option allows you to configure the stripe size of your RAID volume. Available stripe sizes are 4KB, 8KB, 16KB, 32KB, 64KB, 128KB, use the up and down arrow keys to highlight and press ENTER to confirm the stripe size selection.

*RAID1(Mirror) does not offer Stripe Size options.

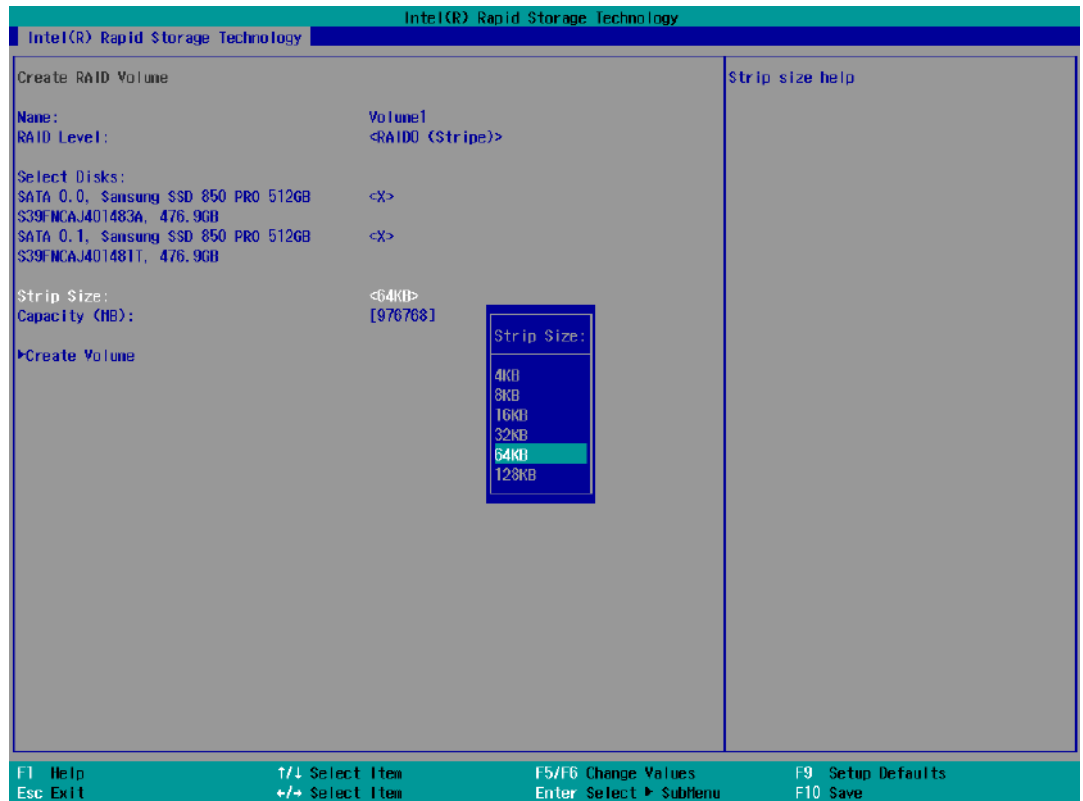

- The Capacity (MB) option allows you to configure the storage capacity of your RAID volume. By default, the full storage capacity will be applied. Once you have entered a capacity, press ENTER to confirm.



- The Create Volume option is the final step in the volume creation process. Highlight “**Create Volume**” and press ENTER to begin creating your RAID volume base on the settings you just configured.

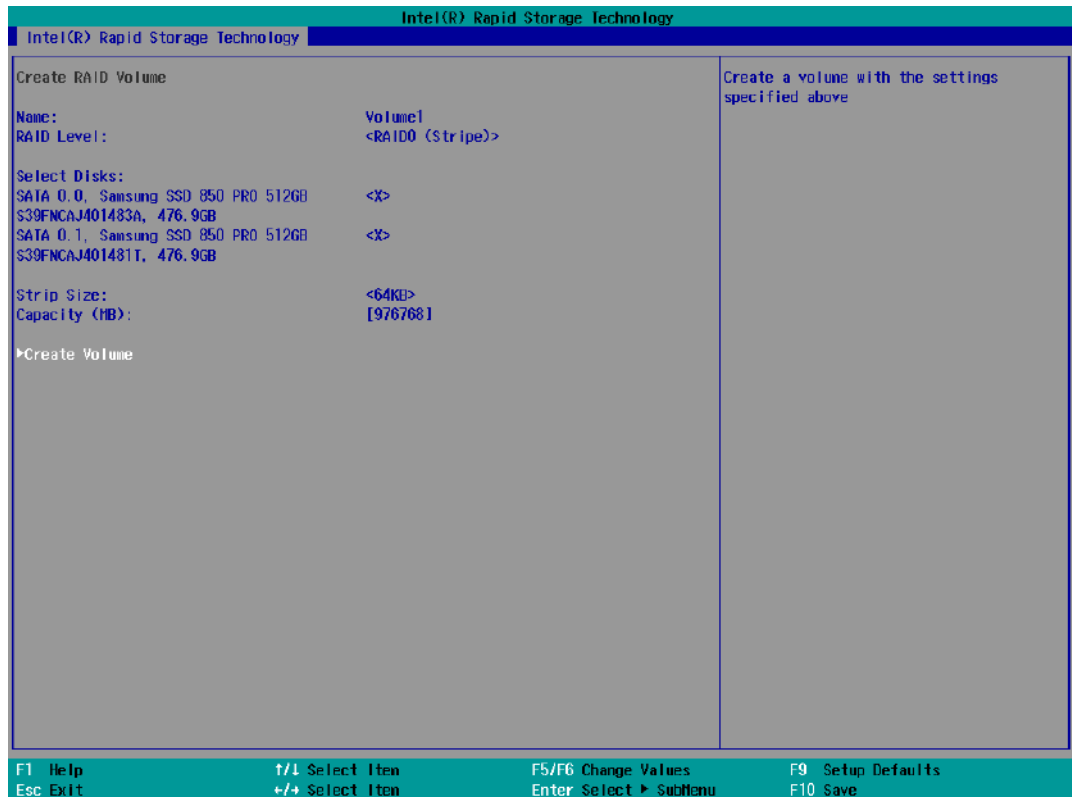

14. A summary and status of the RAID volume will be shown when the RAID volume is successfully created.

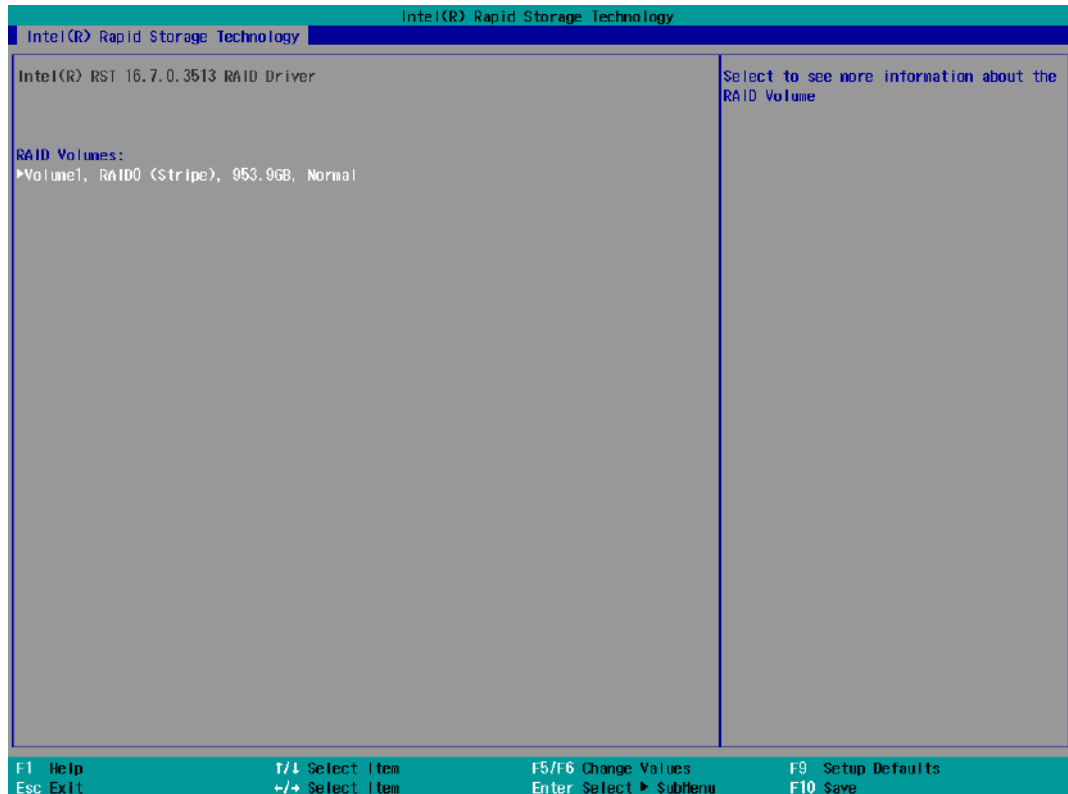

15. Press F10 to save and Esc to exit the Intel® Rapid Storage Technology configuration page.



NOTE

The above process was to create a RAID-0 volume. If you wish to create a RAID-1 volume, please perform steps 5 to 13 in this section and select RAID-1 during step 9.

6 OS Support and Driver Installation

6.1 Operating System Compatibility

The system support most operating system developed for Intel® x86 architecture. The following list contains the operating systems which have been tested by Neosys Technology.

- Microsoft Window 10 (x64)
- Fedora 29**
- Ubuntu 6.04.5 LTS** & Ubuntu18.04.0 LTS**



NOTE

For other Linux OS, Linux kernel should upgrade to 4.15.18.

**For Linux system, user may need to manually compile and install the driver for Intel graphics or I210 GbE controller if the driver is not embedded in kernel. You can visit Intel website for further information.*

***For distributions, graphics driver and RAID function may not be completely implemented in its kernel. You may encounter restrictions when using these features, such as triple independent display and RAID. For optimum operation, it is the users' responsibility to manually check for new drivers and upgrades!*

Neosys may remove or update operating system compatibility without prior notice. Please contact us if your operating system of choice is not on the list.

6.2 Install Drivers Automatically

The system comes with a “Drivers & Utilities” DVD that offers “one-click” driver installation process. It automatically detects your Windows operating system and installs all necessary drivers for you system with a single click.

6.2.1 Install Drivers Automatically

To install drivers automatically, please refer to the following procedures.

1. Insert the “Drivers & Utilities” DVD into a USB DVD-drive connect to your system. A setup utility launches and the following dialog appears.



2. Click on “**Automatic Driver Installation**” and the setup utility will automatically detect your Windows operating system and install all necessary drivers. The installation process takes about 6~8 minutes depending on your Windows version. Once driver installation is done, the setup utility reboots your Windows and you may begin using your system.

6.3 Install Drivers Manually

You can also manually install each driver for the system. Please note when installing drivers manually, you need to install the drivers in the following sequence mentioned below.

6.3.1 For Windows 10 (x64)

The recommended driver installation sequence is

1. Chipset driver (x:\Driver_Pool\Chipset_CFL\Win_10_64\SetupChipset.exe)
2. Graphics driver (x:\Driver_Pool\Graphics_CFL_SKL_APL\Win_10_64\igxpinstall.exe)
3. Audio driver (x:\Driver_Pool\Audio_ALC262\Win_ALL_64\Setup.exe)
4. LAN driver
(x:\Driver_Pool\GbE_I210_I350\Win_10_64_CFL\APPS\PROSETDX\Winx64\DxSetup.exe)
5. ME driver (x:\Driver_Pool\ME_CFL\Win_10_64\SetupME.exe)

6.4 Driver Installation for Watchdog Timer Control

Neosys provides a driver package which contains function APIs for watchdog timer, digital I/ O, per-port PoE power on/off control and other platform-related functions. You should install the driver package (WDT_DIO_Setup.exe) in prior to use these functions.

Windows 10 (x64)

Please execute the driver setup program in the following directory.

x:\Driver_Pool\WDT_DIO\Win7_8_10_64\WDT_DIO_Setup_v2.2.9.x(x64).exe

Windows 10 (WOW64)

Please execute the driver setup program in the following directory.

x:\Driver_Pool\WDT_DIO\Win7_8_10_WOW64\WDT_DIO_Setup_v2.2.9.x(wow64).exe

6.5 Intel® Optane™ Memory BIOS Setup and Driver

Installation

The system is compatible with Intel® Rapid Storage Technology that supports the installation of Intel® Optane™ memory to significantly boost traditional hard disk drive read and write performances. Intel® Optane™ memory is Intel® RST's latest system acceleration solution featuring a dual-media/disk combination (ultrafast media for file and block caching + slow media for storage capacity) that is presented to the host OS as a single SSD. The ultrafast media utilizes PCIe NVMe SSDs that are based on Intel® Optane™ technology with read speed of up to 3000Mb/ sec and write speed of up to 2000Mb/ sec.

To setup Intel® Optane™ memory, please perform the following steps:

1. Press the power button to startup your system (please restart if your system is already up and running) and press F2 to enter BIOS.
2. Go to "Advanced > SATA And RST Configuration".

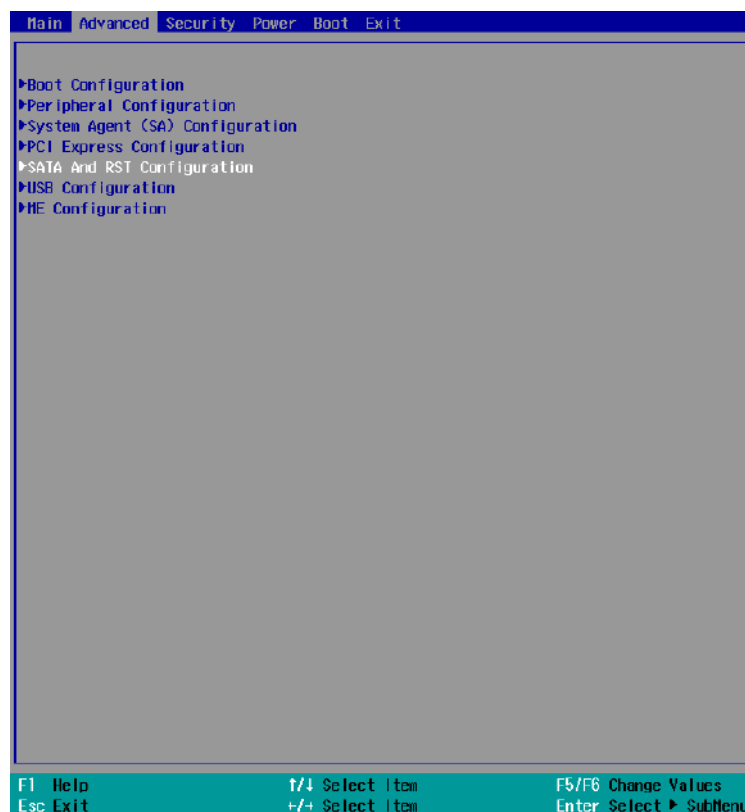

- Go to "SATA Mode Selection", press the Enter key to bring up options, select "Intel RST Premium With Intel Optane System Acceleration" and press ENTER to select the option.

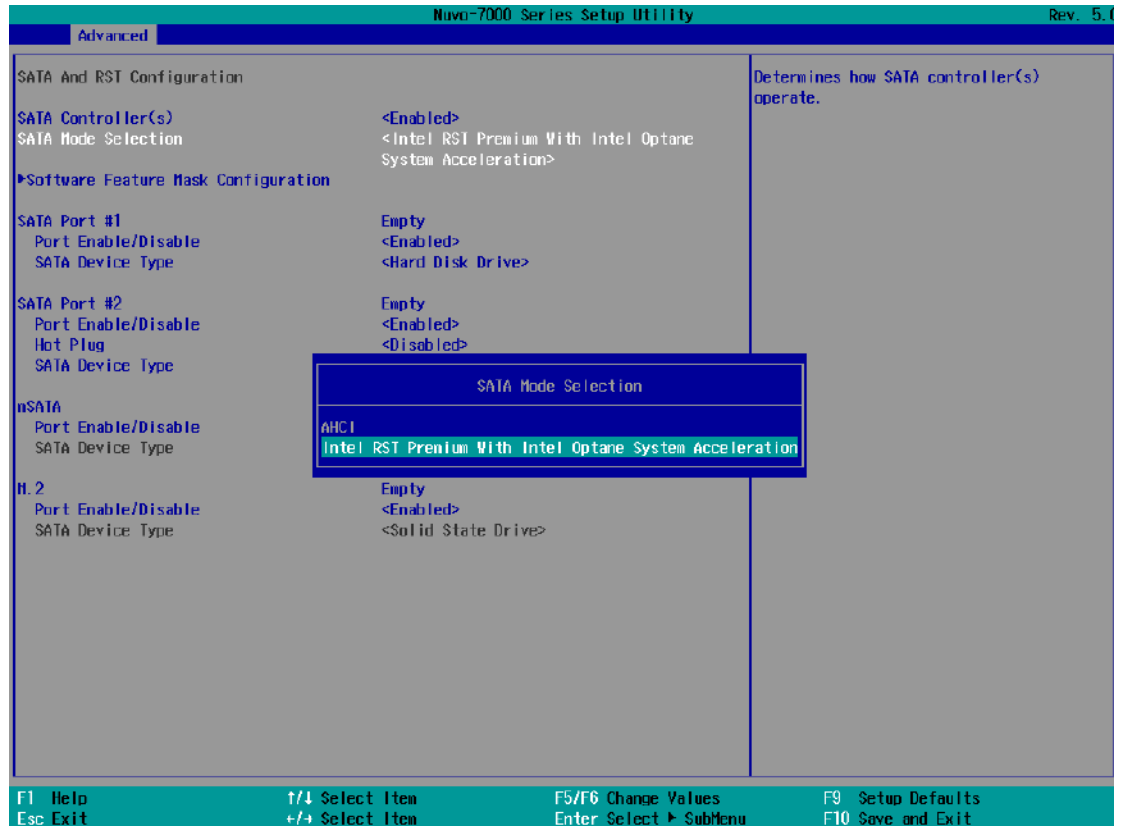

4. Go to “M.2 2280 NVMe Storage Device” and press the Enter key to bring up the selection, select “RST Controlled” and press the Enter key to select the option.



5. Press F10 to save and exit, and allow the system to boot into Windows.
6. In Windows, download [Intel® RST driver](#) if you don't already have it on hand.



Right-click on the SetupOptaneMemory.exe and left-click on “Run as administrator” to execute the setup file.

7. Follow the 6 step setup procedure as instructed.

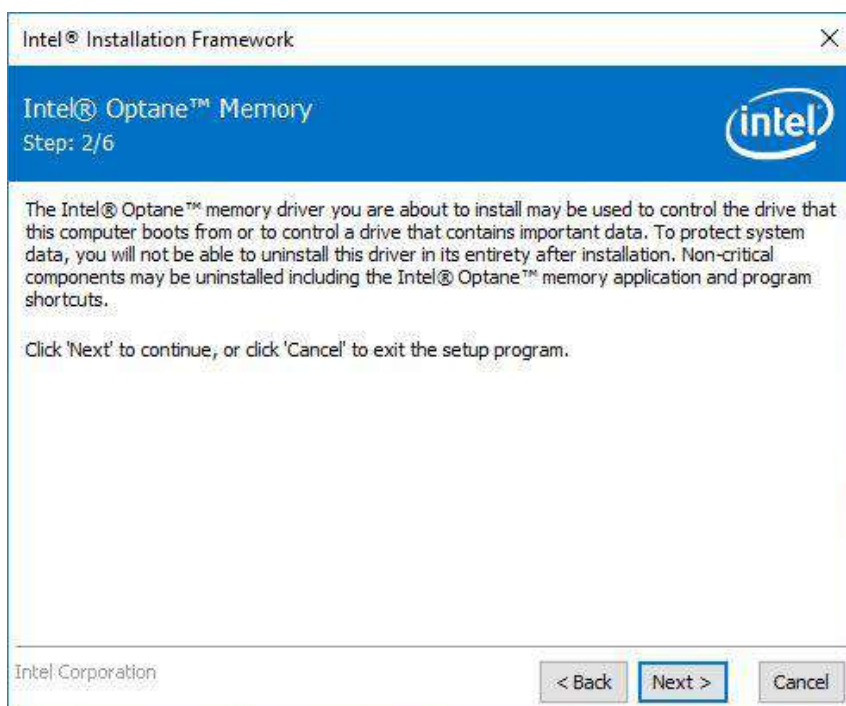
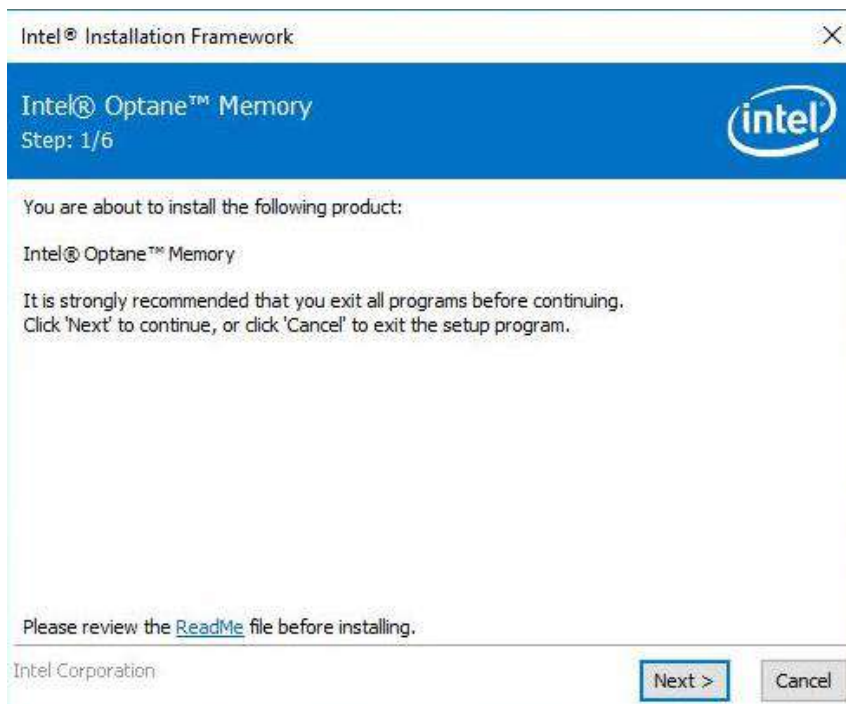

8. Check the "I accept the terms in the License Agreement" box and click on "Next >" to continue the installation process.

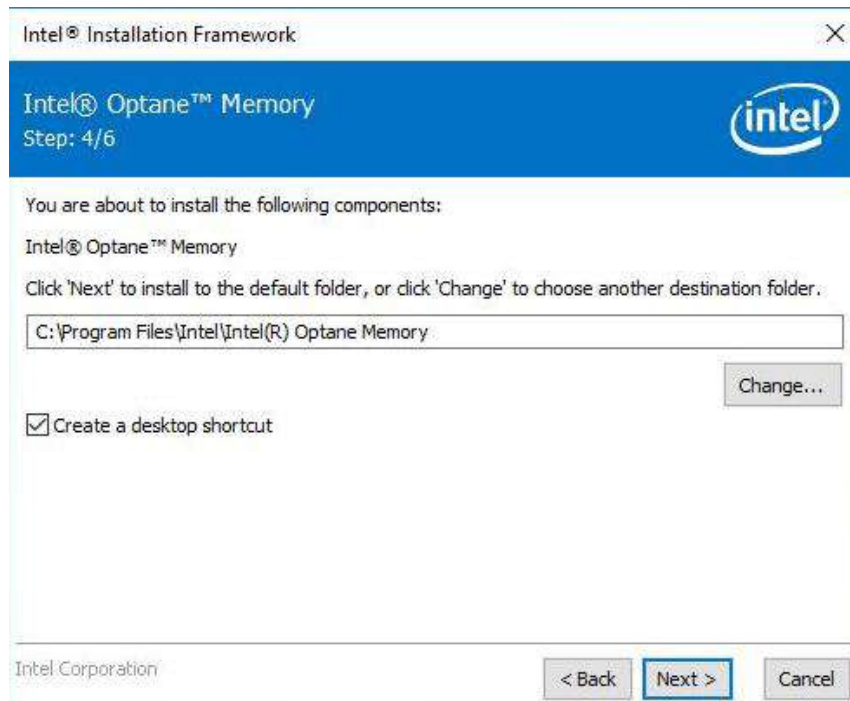
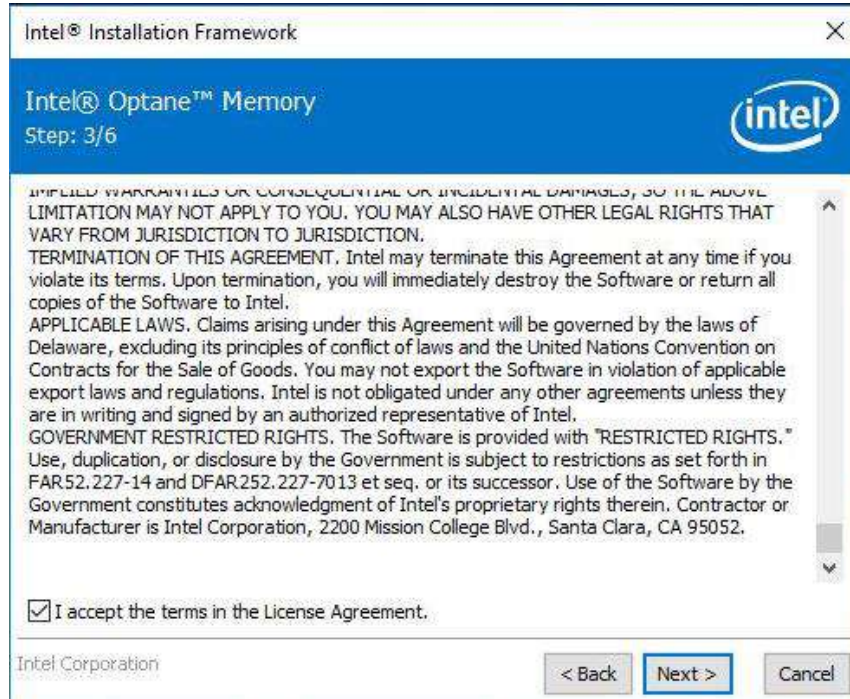

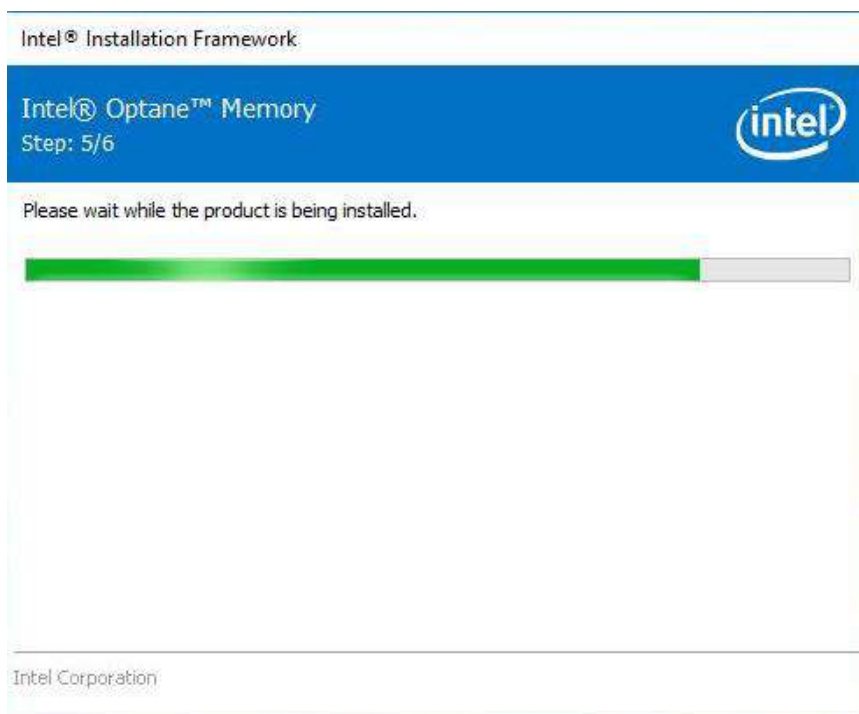

9. When done, click on “Finish” and restart the system.

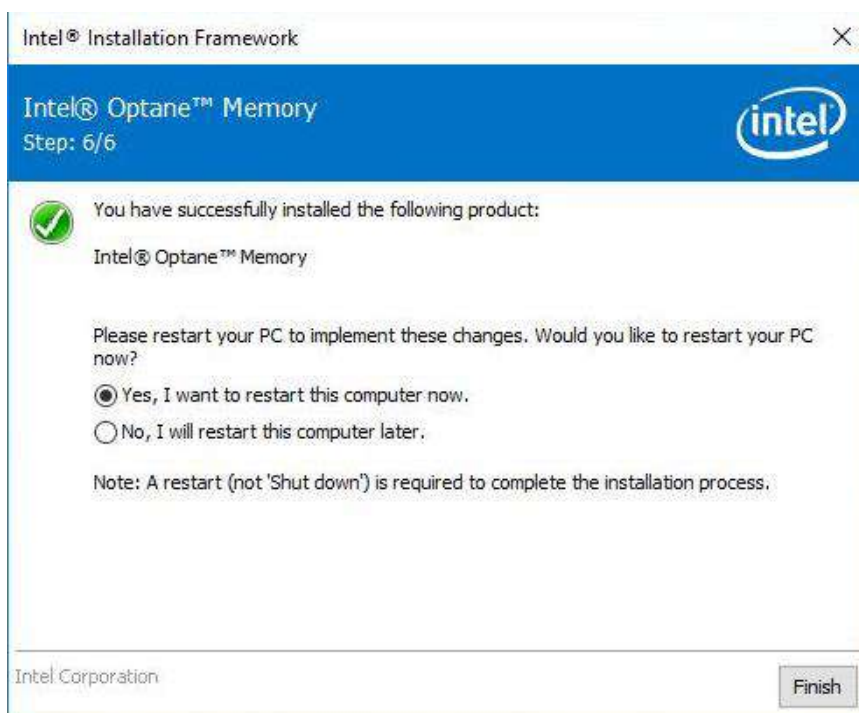

- Upon system restart, the following initialization screen will appear. Click on Next to continue.

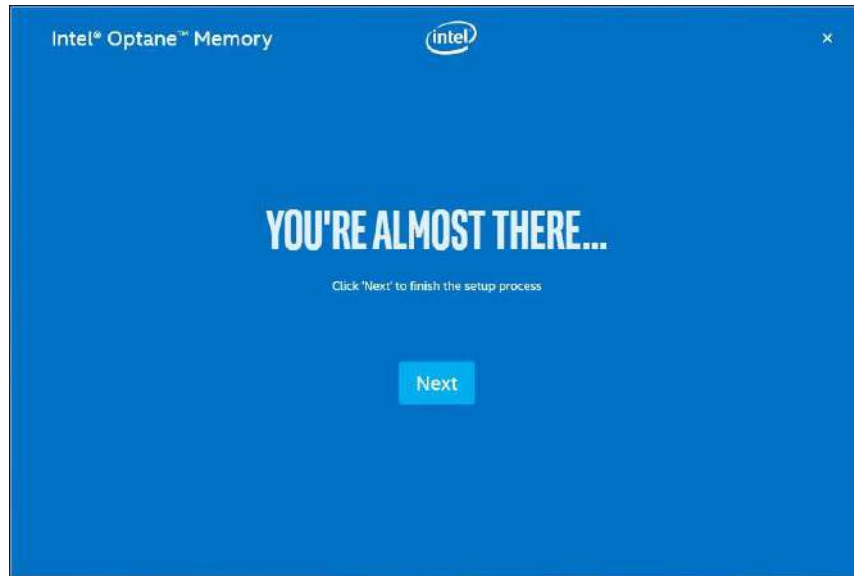

- In the Setup section, you will see your Intel® Optane™ memory drive and compatible drive(s) that can be accelerated. Click on the downward arrow to bring up a selection of drives to be accelerated. Click on “Enable” when ready.

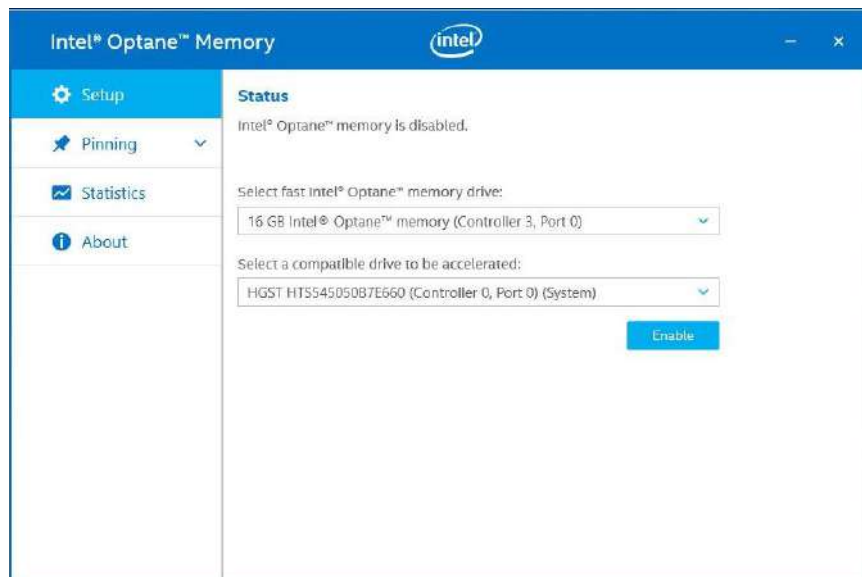

12. The data backup warning will appear, please backup any data you may have stored on your Intel® Optane™ memory module before proceeding. Check the box “Erase all data on Intel® Optane™ memory module” and click on Continue.

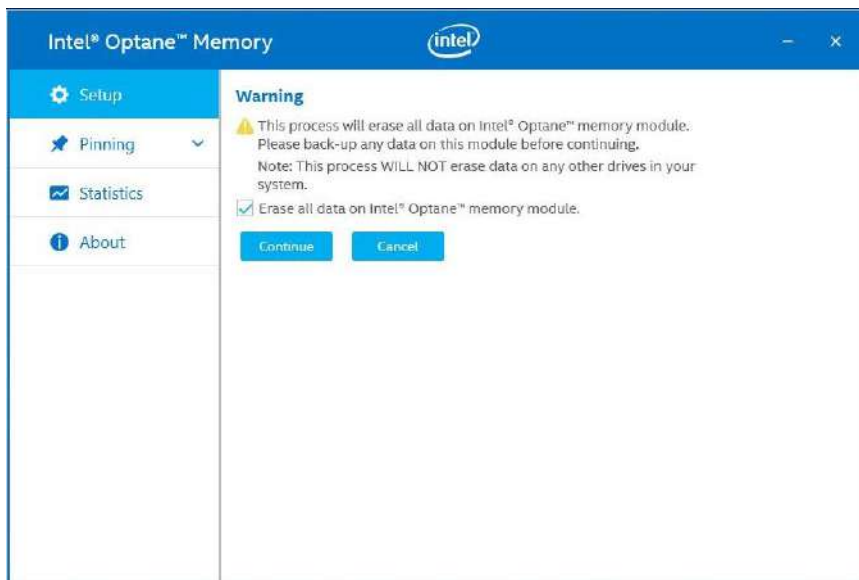

13. When the Intel® Optane™ memory module has been enabled, the installation window and a notification window at the bottom right corner will prompt you to restart the system.

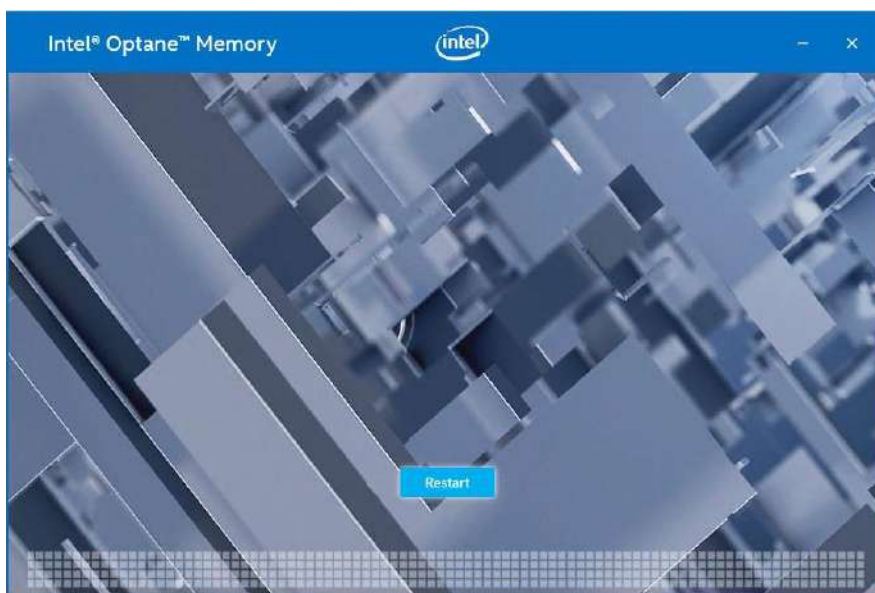

- Upon system restart, a successful enablement message will appear to indicate the Intel® Optane™ memory module has been enable successfully.

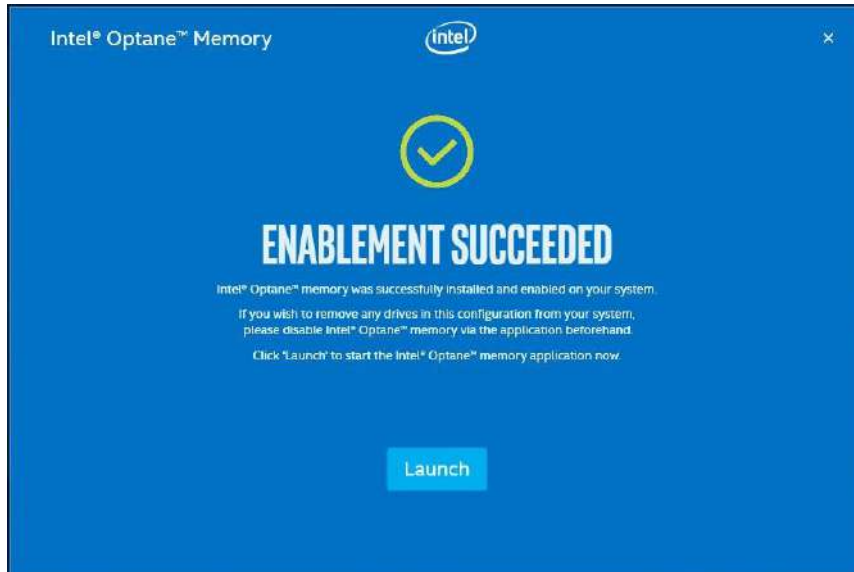

- Once enabled, the RST software Setup section should show your configuration information.

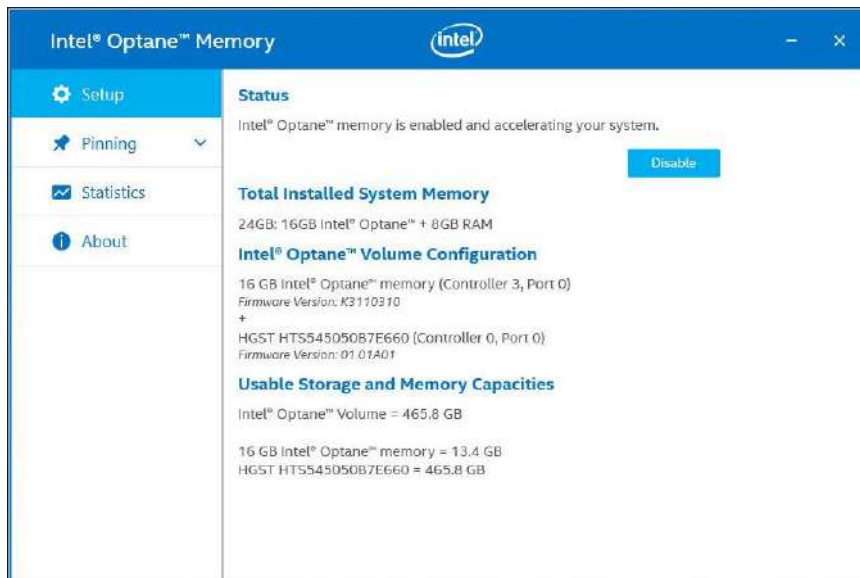

7 CAP Energy Management Technology ~ Power

Backup Parameter Configurer

By controlling fundamental techniques such as charge/ discharge control, active load balance and DC/ DC regulation, Neousys is able to design and create a reliable ultracapacitor-based power backup system. However, the real challenge is how to get the most out of the capacitor energy while ensuring the system shuts down safely during a power blackout.

7.1 CAP Energy Management Technology

The patented architecture (R.O.C. patent I598820) incorporates a microprocessor along with supercapacitors and charge/ discharge controller. The proprietary firmware embedded in the MCU not only monitors energy level continuously, it also automatically initiates soft-shutdown to prevent data loss/ corruption.

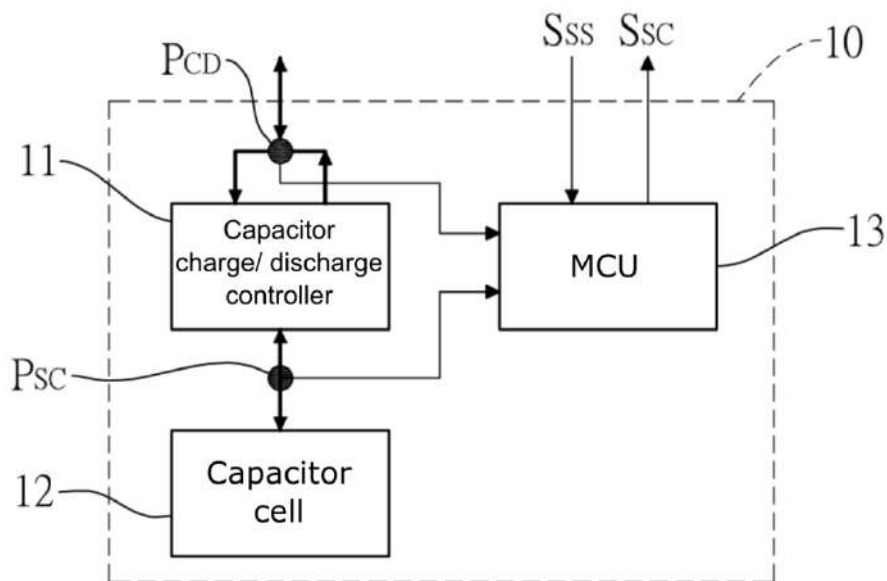

By providing sophisticated real-time energy monitoring, high/ low voltage protection and auto/ manual shutdown control, the dedicated interface help users better manage and efficiently utilize their PB standalone module. The software can also extend the lifespan of supercapacitors up to 4.8x by controlling charge/ discharge cycles.

7.2 Power Backup Parameter Configurer

7.2.1 Executing PB2500J Parameter Configurer

The PB2500J Parameter Configurer is an application that allows the user to monitor and manage the connected PB2500J-PCIe/ CSM.

Once you have installed PB2500J-PCIe/ CSM and have connected it to the host controller COM5 port (configured in RS-232 mode). You may copy the “PB2500J_Configurer” executable (.exe) file on the Utility DVD to your computer desktop and run it by right-clicking on the exe file and select to “Run as administrator” from your desktop (installation not required).

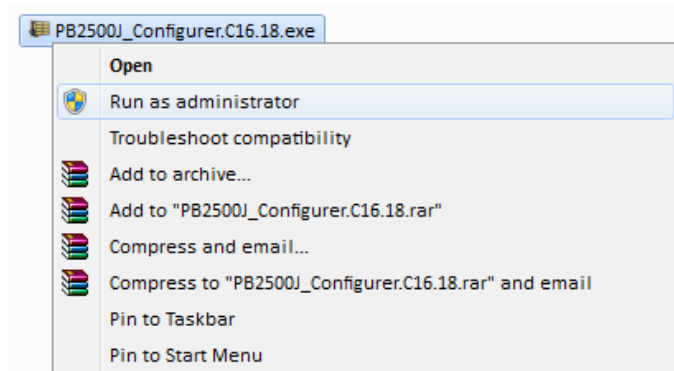

7.2.2 PB-2500J Parameter Configurer

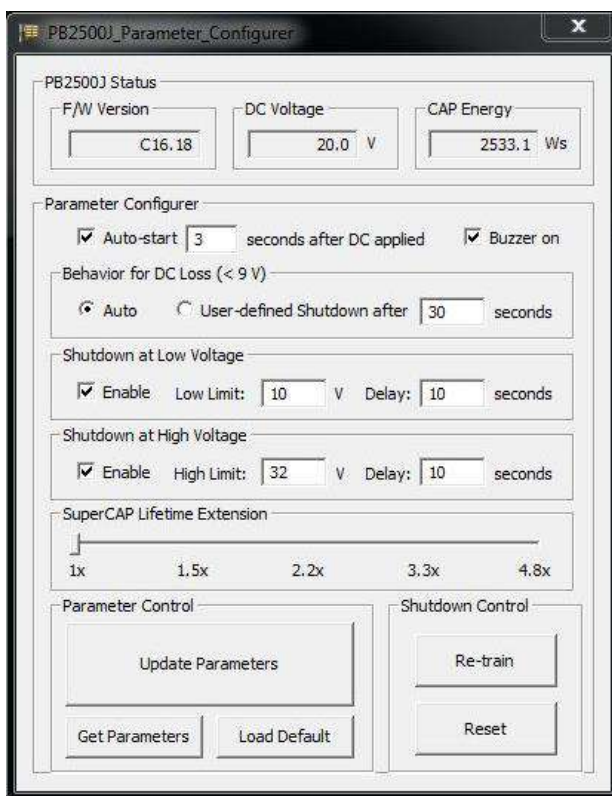

Item	Description	
F/W Version	Shows the firmware version of your PB-2500J	
DC Voltage	Shows the current input voltage of your PB-2500J	
CAP Energy	Shows the current charged energy status (rated 2500Ws Max.)	
Parameter Configurer	Auto-start _ seconds after DC applied	The time delay (in seconds) to start PB-2500J once your computer has been powered on.
	Behavior for DC Loss (<9V)	This allows you to set the delay time (in seconds) to shutdown when DC voltage drops below 9V.
	Shutdown at Low Voltage	This allows you set the low voltage limit and delay time (in seconds) to shutdown (Note: DO NOT set voltage lower than 10V)
	Shutdown at High Voltage	This allows you set the high voltage limit and delay time (in seconds) to shutdown (Note: DO NOT set voltage higher than 32V)
	SuperCAP Lifetime Extension	This setting allows you to extend the lifespan of the Supercapacitors on your PB-2500J. Lifespan extension settings are approximate figures and may not exactly reflect real world applications.
	Parameter Control	Update Parameters: Click on this button for new parameters to take effect. Get Parameters: Click on this button to acquire current parameters. Load Default: Clicking on this button to load default parameters.
	Shutdown Control	Re-train: This button will re-train PB-2500J to be customized to the system's required shutdown time. Reset: This button will reset (erase) previous Re-train shutdown settings.

7.2.3 Auto-start

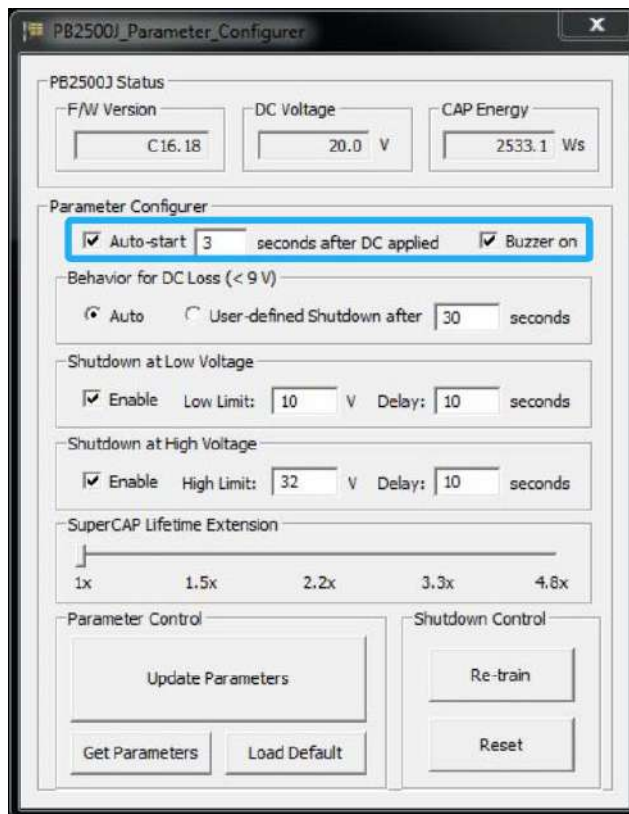

Auto-start Settings

<p>Auto-start _ seconds after DC applied</p>	<p>If the “Auto-start” box is checked, the system will start __ seconds after the 3-pin pluggable terminal block is plugged into the system (DC applied).</p> <p>If the “Auto-start” box is not checked, once you have plugged in the 3-pin pluggable terminal block, you will need to press the power button to turn the system on.</p>
<p>Buzzer on</p>	<p>If the “Buzzer on” box is checked, a buzzer sound will sound as soon as the supercapacitors start to discharge (supplying power to the system).</p> <p>If the “Buzzer on” box is not checked, no buzzer sound will be made when the supercapacitors start to discharge.</p>



NOTE

For new parameters to take effect, you must click on “[Update Parameters](#)” and follow procedure instructions. Please refer to the relevant section for details.

7.2.4 Behavior for DC Loss (<9V)

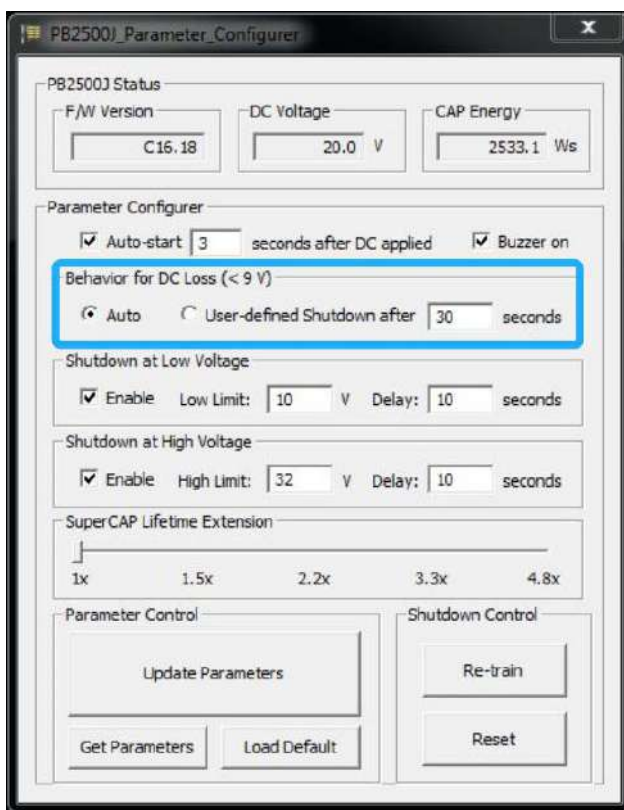

Behavior for DC Loss (<9V) Settings

Auto	If the “ Auto ” box is selected, the delay shutdown time will be pre-determined by the MCU when you “Re-train” PB-2500J.
User-defined Shutdown after _ seconds	If the “ User-defined Shutdown after _ seconds ” is selected, when the input voltage drops below 9V, the shutdown process will be initiated by the user defined time in seconds.



NOTE

For new parameters to take effect, you must click on “[Update Parameters](#)” and follow procedure instructions. Please refer to the relevant section for details.

7.2.5 Shutdown at Low Voltage

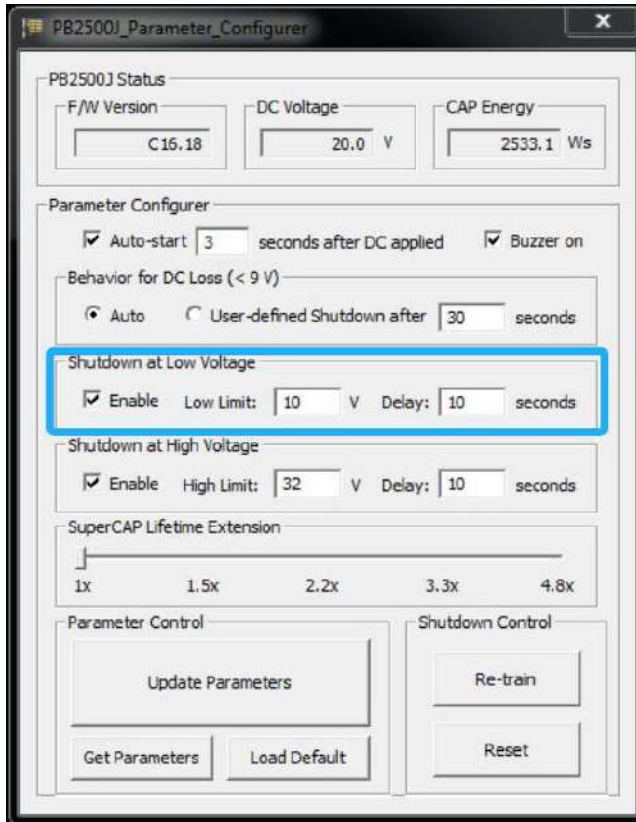

Shutdown at low voltage settings

Enable	If the “ Enable ” box is checked, the shutdown process will be determined by the Low Limit: _ V and Delay: _ seconds settings.
Low Limit: _ V	If the “ Enable ” box is checked, the shutdown process will be initiated by low voltage limit setting (Low Limit: _ V) and the Delay: _ seconds.
Delay: _ seconds	If the “ Enable ” box is checked, the shutdown process will be initiated in _ seconds (Delay: _ seconds) when the low voltage limit setting (Low Limit: _ V) is reached.



NOTE

For new parameters to take effect, you must click on “[Update Parameters](#)” and follow procedure instructions. Please refer to the relevant section for details.

7.2.6 Shutdown at High Voltage

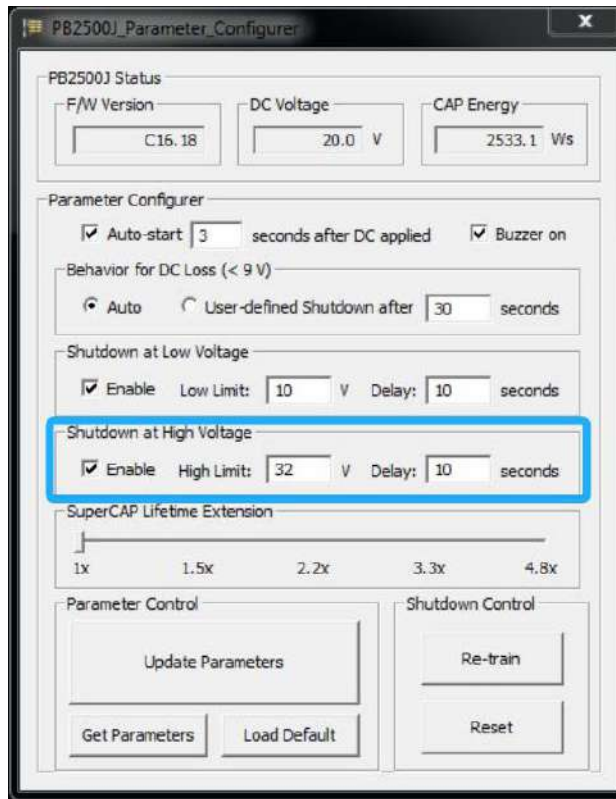

Shutdown at high voltage settings

Enable	If the “ Enable ” box is checked, the shutdown process will be determined by the High Limit: _ V and Delay: _ seconds settings.
High Limit: _ V	If the “ Enable ” box is checked, the shutdown process will be initiated by high voltage limit setting (High Limit: _ V) and the Delay: _ seconds.
Delay: _ seconds	If the “ Enable ” box is checked, the shutdown process will be initiated in _ seconds (Delay: _ seconds) when the high voltage limit setting (High Limit: _ V) is reached.



NOTE

For new parameters to take effect, you must click on “[Update Parameters](#)” and follow procedure instructions. Please refer to the relevant section for details.

7.2.7 SuperCAP Lifetime Extension

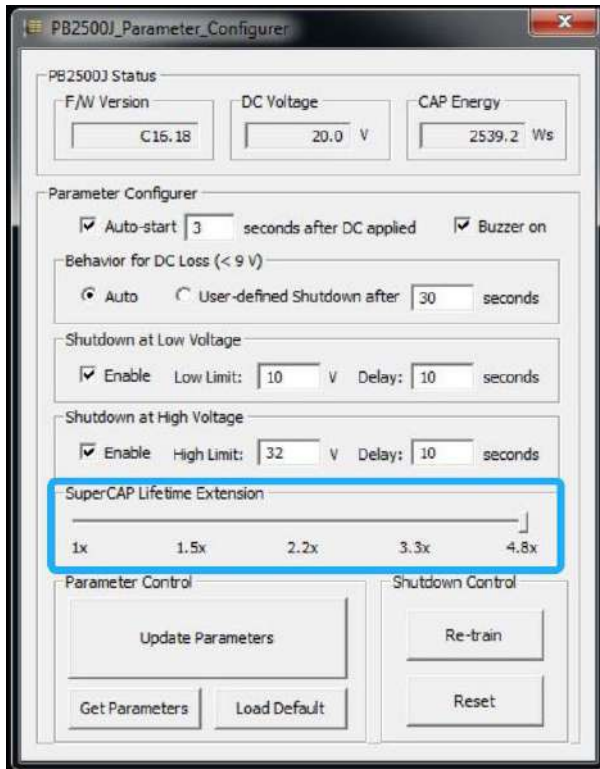

SuperCAP lifetime extension settings

The SuperCAP lifetime extension setting is an automated setting when users only need to click on the bar, drag it to the desired lifetime extension setting, click on the “Update Parameters” and follow procedure instruction for settings to take effect.



NOTE

For new parameters to take effect, you must click on “[Update Parameters](#)” and follow procedure instructions. Please refer to the relevant section for details.

7.2.8 Update Parameters

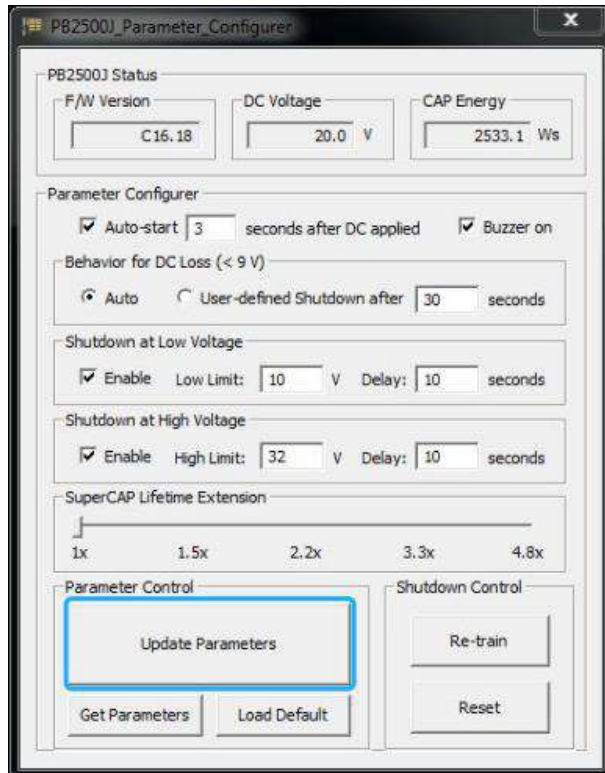

Whenever you enter/ adjust a new parameter or parameters, for the new settings to take effect, you must perform the following steps:

1. Click on the “Update Parameters” button and the following dialogue will appear.

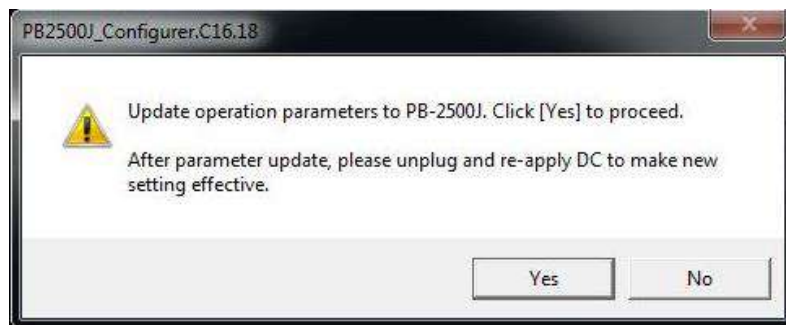

2. Click on yes, manually shutdown your system by going to “Start > Shut down”.
3. Once the system has shut down, unplug the 3-pin pluggable terminal block.
4. Wait for 5~10 seconds, plug in the 3-pin pluggable terminal block and start up your system for the new settings to take effect.

7.2.9 Get Parameters

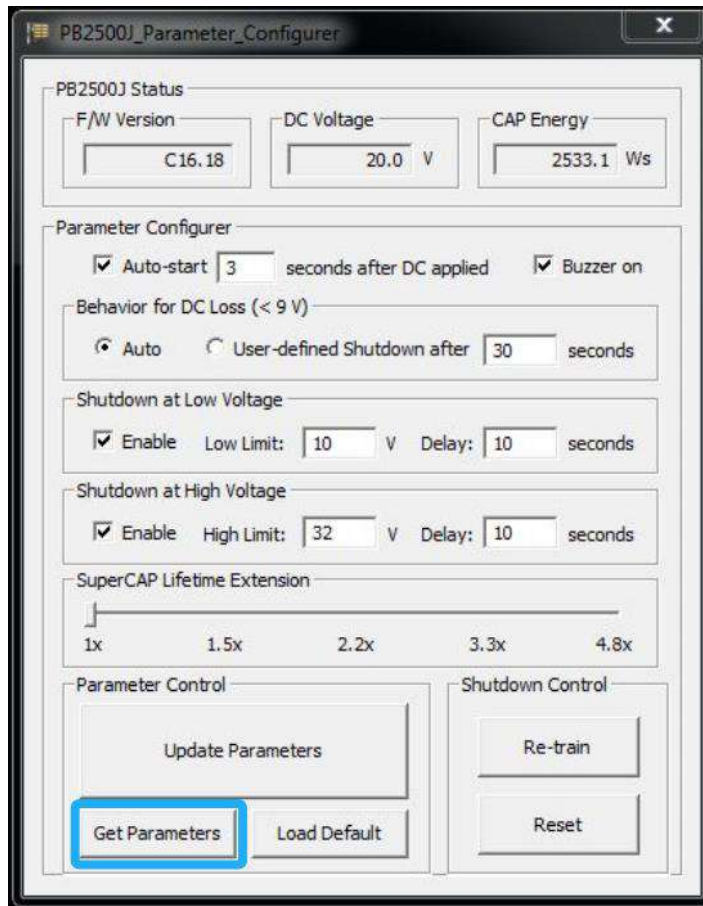

Click on “Get Parameters” to manually acquire the current PB-2500J status for F/W version, DC voltage and current stored CAP energy.

7.2.10 Load Default

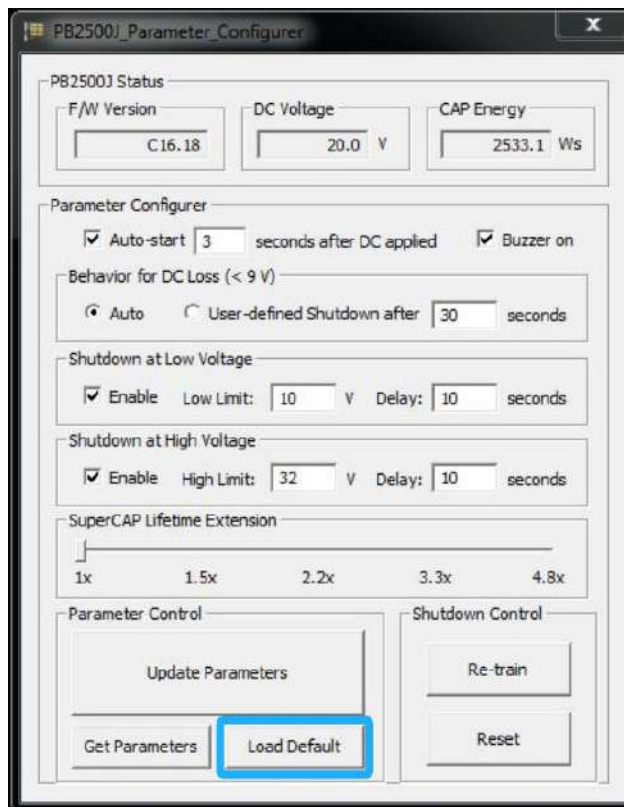

You may set PB-2500J back to the original settings by clicking on “Load Default” to reset all changes you have made previously.

7.2.11 Re-train

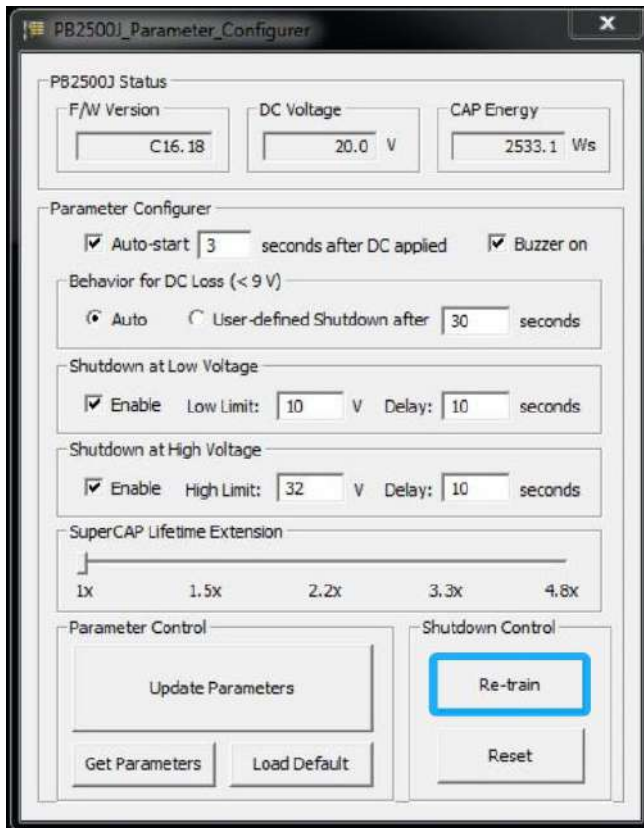

The Re-train function is to customize the PB-2500J to your system’s required shutdown time! By clicking on “Re-train”, a shutdown action will be initiated so the time required to shutdown can be memorized.

7.2.12 Reset

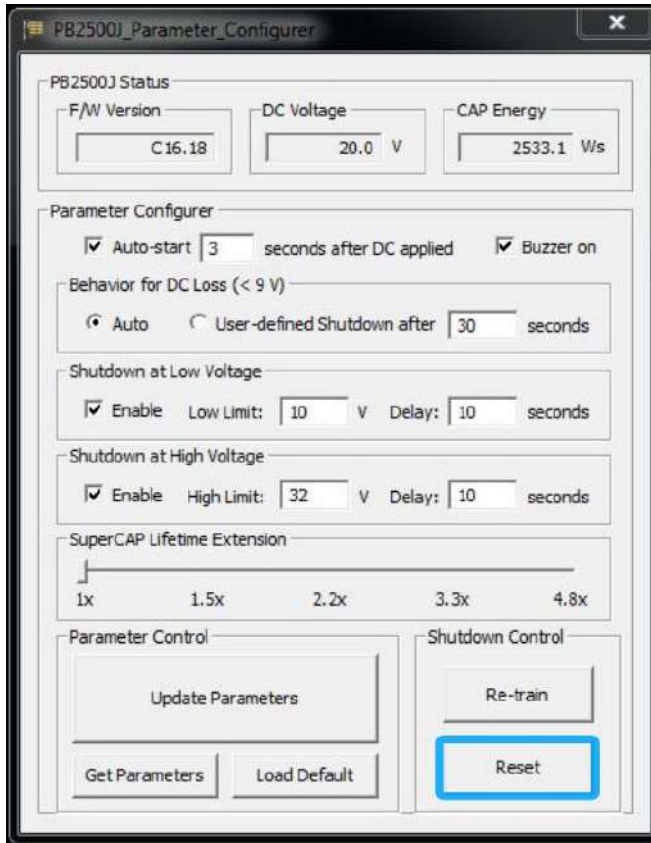

By clicking on Reset, it will erase all previous Re-train settings and hence result in immediate shutdown when a command is issued.

Appendix A: Using WDT & DIO

The watchdog timer (WDT) function to ensure reliable system operation. The WDT is a hardware mechanism to reset the system if the watchdog timer is expired. Users can start the WDT and keeping resetting the timer to make sure the system or program is running. Otherwise, the system shall be reset.

In this section, we'll illustrate how to use the function library provided by Neosys to program the WDT functions. Currently, WDT driver library supports Windows 10 x64 and WOW64 platform. For other OS support, please contact Neosys Technology for further information.

Installing WDT_DIO Library

The WDT_DIO function library is delivered in the form of a setup package named **WDT_DIO_Setup.exe**. In prior to program WDT, you should execute the setup program and install the WDT library. Please use the following WDT_DIO_Setup packages according to your operating systems and application.

- For Windows 10 64-bit OS with 64-bit application (x64 mode), please install WDT_DIO_Setup_v2.3.0 (x64).exe or later version.
- For Windows 10 64-bit OS with 32-bit application (WOW64 mode), please install WDT_DIO_Setup_v2.3.0 (wow64).exe or later version.

WDT and DIO Library Installation

To setup WDT & DIO Library, please follow instructions below.

1. Execute **WDT_DIO_Setup.2.3.0.exe** and the following dialog appears.

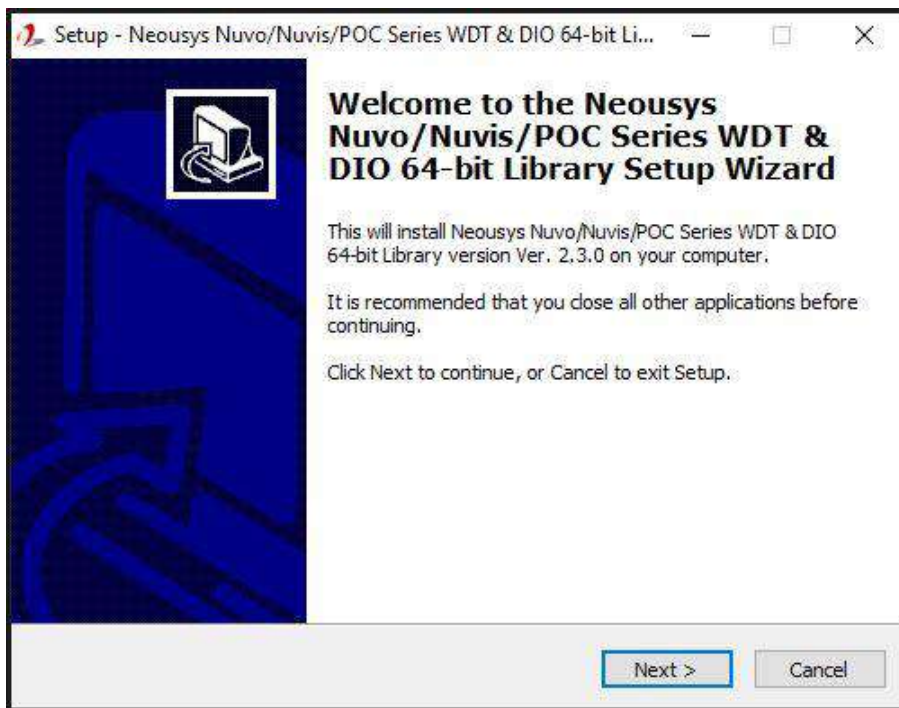

2. Click "Next >" and specify the directory of installing related files. The default directory is *C:\Neosys\WDT_DIO*.

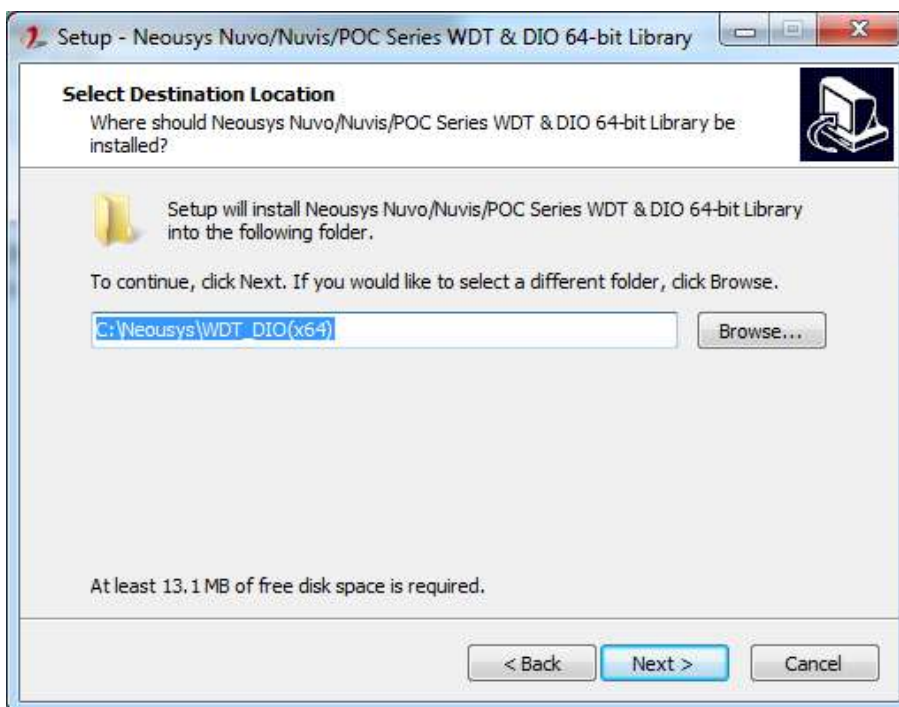

3. Once the installation has finished, a dialog will appear to prompt you to reboot the system. The WDT & DIO library will take effect after the system has rebooted.

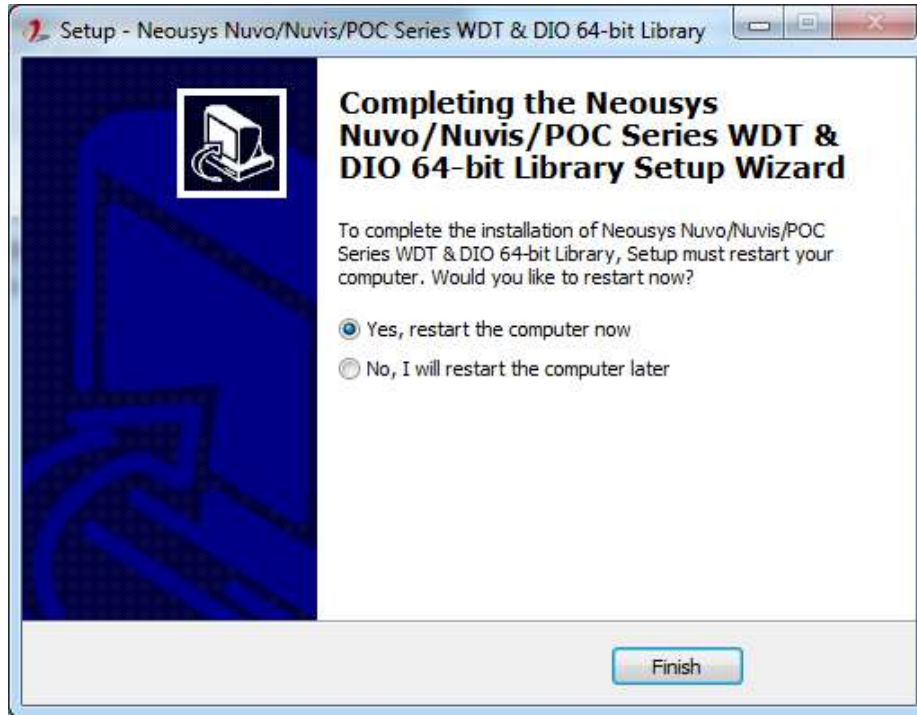

4. When programming your WDT or DIO program, the related files are located in

Header File:	\Include
Library File:	\Lib
Function	\Manual
Reference:	
Sample Code:	\Sample\WDT_Demo (Demo for Watchdog Timer) \Sample\DIO_Demo (Demo for DIO Control) \Sample\COS_Demo (Demo for change-of-state DI) \Sample\CAN_Demo (Demo for CAN bus manipulation) \Sample\IGN_Demo (Demo for ignition status manipulation) \Sample\POE_Demo (Demo for PoE per-port on/off control)

WDT Function Reference

InitWDT

Syntax	BOOL InitWDT(void);
Description:	Initialize the WDT function. You should always invoke InitWDT() before set or start watchdog timer.
Parameter	None
Return Value	TRUE: Successfully initialized FALSE: Failed to initialize
Usage	BOOL bRet = InitWDT();

SetWDT

Syntax	BOOL SetWDT(WORD tick, BYTE unit);
Description	Set timeout value and unit for watchdog timer. When InitWDT() is invoked, a default timeout value of 255 seconds is assigned.
Parameter	<i>tick</i> WORD value (1 ~ 65535) to indicate timeout ticks. <i>unit</i> BYTE value (0 or 1) to indicate unit of timeout ticks. 0 : unit is minute 1 : unit is second
Return Value	If value of unit is correct (0 or 1), this function returns TRUE, otherwise FALSE.
Usage	WORD tick=255; BYTE unit=1; //unit is second. BOOL bRet = SetWDT(tick, unit); //timeout value is 255 seconds

StartWDT

Syntax	BOOL StartWDT(void);
Description	Starts WDT countdown. Once started, the WDT LED indicator will begin blinking. If ResetWDT() or StopWDT is not invoked before WDT countdowns to 0, the WDT expires and the system resets.
Parameter	None
Return Value	If the timeout value is given in correct format (WDT started), this function returns TRUE, otherwise FALSE
Usage	BOOL bRet = StartWDT();

ResetWDT

Syntax	BOOL ResetWDT(void);
Description	Reset the timeout value to the value given by SetWDT().If ResetWDT() or StopWDT is not invoked before WDT countdowns to 0, the WDT expires and the system resets.
Parameter	None
Return Value	Always returns TRUE
Usage	BOOL bRet = ResetWDT();

StopWDT

Syntax	BOOL StopWDT(void);
Description	Stops the countdown of WDT. When WDT has stopped, the WDT LED indicator stops blinking.
Parameter	None
Return Value	Always returns TRUE
Usage	BOOL bRet = StopWDT();

Appendix B: PoE On/ Off Control

The system offers 802.3at PoE+ ports with a unique feature to allow users manually turn on or off the power supply of each PoE port. This can be function can be useful in power device (PD) fault-recovery or power reset.

The function APIs are encapsulated in Neousys WDT_DIO driver package. Please follow the instructions in [Appendix B Watchdog Timer & Isolated DIO](#) to install the driver package prior to programming PoE on/off control function.

GetStatusPoEPort

Syntax	BYTE GetStatusPoEPort (Byte port);
Description	Get current on/off status of designated PoE port.
Parameter	<i>port</i> BYTE value specifies the index of PoE port. Please refer to the following illustration, <i>port</i> should be a value of 1 ~ 8.
Return Value	BYTE value indicating PoE on/off status 0 if port is disabled (off) 1 if port is enabled (on)
Usage	BYTE bEnabled = GetStatusPoEPort (3); //Get on/off status of PoE Port#3

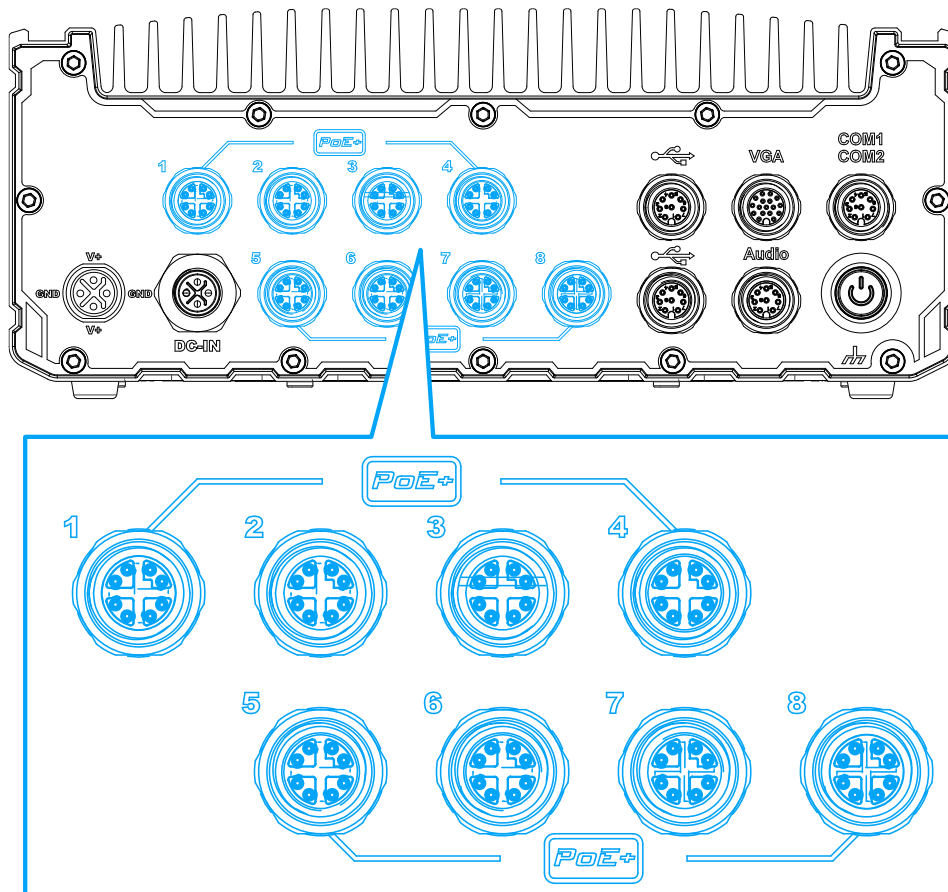

EnablePoEPort

Syntax	BOOL EnablePoEPort (BYTE port);
Description	Turn on PoE power of designated PoE port.
Parameter	<i>port</i> BYTE value specifies the index of PoE port. Please refer to the following illustration, <i>port</i> should be a value of 1 ~ 8.
Return Value	TRUE if enabled success FALSE if fail to enable.
Usage	BOOL bRet = EnablePoEPort (3); //Turn on PoE Port#3

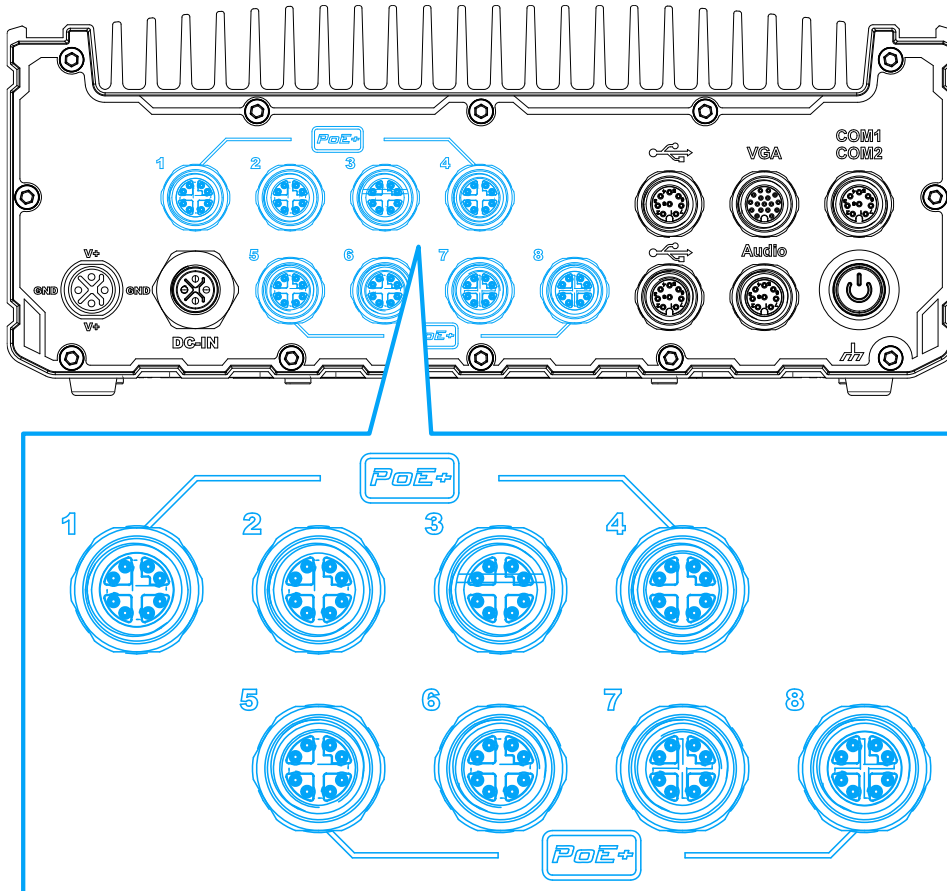

DisablePoEPort

Syntax	BOOL DisablePoEPort (BYTE port);
Description	Turn off PoE power of designated PoE port
Parameter	<i>port</i> BYTE value specifies the index of PoE port. Please refer to the following illustration, <i>port</i> should be a value of 1 ~ 8
Return Value	TRUE if disabled success FALSE if fail to disable
Usage	BOOL bRet = DisablePoEPort (3); //Turn off PoE Port#3

